



# CE TEST REPORT

FOR

VGA to Video converter

Model: VC0XXX (X=0~9,A~Z or space)

Issued to

SMART CABLING & TRANSMISSION CORP.

10F, No.493, Chung-Cheng Rd., Hsin Tien Dist., New Taipei City 231, Taiwan,  
R.O.C.



Issued by

PEP Testing Laboratory

<b>Open Site</b>	<b>No.120, Ln. 5, Hudong St., Xizhi Dist., New Taipei City 221, Taiwan (R.O.C.)</b>	
<b>EMC Test Site</b>	<b>Xizhi Office and Lab</b>	<b>12F.-3, No.27-1, Ln. 169, Kangning St., Xizhi Dist., New Taipei City 221, Taiwan (R.O.C.)</b>

*Note: This test refers exclusively to the test presented test model and sample. This report shall not be reproduced except in full, without the written approval of PEP Certification Corp. This document may be altered or revised by PEP Certification Corp. Personnel only, and shall be noted in the revision section of the document.*



---

<b>TABLE OF CONTENTS</b>	<b>2</b>
<b>1. GENERAL INFORMATION</b>	<b>4</b>
1.1 DESCRIPTION OF THE TESTED SAMPLES	5
1.2 SUMMARY OF TEST RESULT	6
1.3 TEST METHODOLOGY	7
1.4 DESCRIPTION OF THE SUPPORT EQUIPMENTS	8
1.5 FEATURES OF EUT:PLEASE REFER TO USER MANUAL OR PRODUCT SPECIFICATION.	8
<b>2. INSTRUMENT AND CALIBRATION</b>	<b>9</b>
2.1 MEASURING INSTRUMENT CALIBRATION	9
2.2 TEST AND MEASUREMENT EQUIPMENT	9
2.3 TEST PERFORMED	10
2.4 APPENDIX	11
<b>3. CONDUCTED EMISSION MEASUREMENT</b>	<b>13</b>
3.1 TEST SET-UP	13
3.2 LIMIT	13
3.3 TEST PROCEDURE	13
3.4 TEST SPECIFICATION	14
3.5 RESULT: PASSED	14
3.6 TEST DATA:	14
<b>4. RADIATED EMISSION MEASUREMENT</b>	<b>15</b>
4.1 TEST SETUP	15
4.2 LIMIT	16
4.3 TEST PROCEDURE	16
4.4 TEST SPECIFICATION	17
4.5 RESULT: PASSED	17
4.6 TEST DATA:	17
PLEASE REFER TO APPENDIX 2	17
<b>5. POWER HARMONIC MEASUREMENT</b>	<b>18</b>
5.1 TEST SETUP	18
5.2 LIMIT OF HARMONIC CURRENT	18
5.3 TEST PROCEDURE	18
5.4 TEST SPECIFICATION	18
5.5 RESULT: PASSED	18
5.6 TEST DATA:	18
<b>6. VOLTAGE FLUCTUATIONS</b>	<b>19</b>
6.1 TEST SETUP	19
6.2 VOLTAGE FLUCTUATIONS TEST	19
6.3 TEST PROCEDURE	19
6.4 TEST SPECIFICATION	19
6.5 RESULT: PASSED	19
6.6 TEST DATA:	19
<b>7. ELECTROSTATIC DISCHARGE IMMUNITY TEST (ESD)</b>	<b>20</b>
7.1 TEST PROCEDURE	20
7.2 TEST SETUP	20
7.3 TEST LEVEL	20
7.4 TEST RESULT.	21
<b>8. RADIATED SUSCEPTIBILITY MEASUREMENT (RS)</b>	<b>24</b>
8.1 TEST SETUP	24
8.2 TEST PROCEDURE	24



---

8.3	TEST LEVEL-----	24
8.4	TEST PROCEDURE-----	25
8.5	TEST RESULT-----	25
<b>9.</b>	<b>ELECTRICAL FAST TRANSIENT/BURST (EFT) -----</b>	<b>26</b>
9.1	TEST SETUP-----	26
9.2	TEST PROCEDURE-----	26
9.3	TEST PROCEDURE-----	26
9.4	TEST LEVEL-----	27
9.5	TEST RESULT-----	27
<b>10.</b>	<b>SURGE -----</b>	<b>28</b>
10.1	TEST SETUP-----	28
10.2	TEST PROCEDURE-----	28
10.3	TEST LEVEL-----	28
10.4	TEST PROCEDURE-----	29
10.5	TEST RESULT-----	29
<b>11.</b>	<b>IMMUNITY TEST TO CS CONDUCTED DISTURBANCE (CS) -----</b>	<b>30</b>
11.1	TEST SETUP-----	30
11.2	TEST PROCEDURE-----	30
11.3	TEST LEVEL-----	30
11.4	TEST PROCEDURE-----	31
11.5	TEST RESULT-----	31
<b>12.</b>	<b>POWER FREQUENCY MAGNETIC FIELD (MAGNETIC)-----</b>	<b>33</b>
12.1	TEST SETUP-----	33
12.2	TEST STANDARD-----	33
12.3	TEST LEVEL-----	33
12.4	TEST PROCEDURE-----	33
12.5	TEST RESULT-----	34
<b>13.</b>	<b>VOLTAGE DIPS AND INTERRUPTION MEASUREMENT -----</b>	<b>35</b>
13.1	TEST SETUP-----	35
13.2	TEST PROCEDURE-----	35
13.3	TEST LEVEL-----	36
13.4	TEST PROCEDURE-----	36
13.5	TEST RESULT-----	37
<b>14.</b>	<b>PERFORMANCE CRITERIA -----</b>	<b>38</b>
<b>15.</b>	<b>MEASUREMENT UNCERTAINTY-----</b>	<b>39</b>
<b>APPENDIX 1</b>		
<b>PHOTOS OF TEST CONFIGURATION</b>		
<b>APPENDIX 2</b>		
<b>TEST DATA</b>		
<b>APPENDIX 3</b>		
<b>PHOTOS OF EUT</b>		



## 1. GENERAL INFORMATION

**Applicant** : SMART CABLING & TRANSMISSION CORP.  
**Address** : 10F, No.493, Chung-Cheng Rd., Hsin Tien Dist., New Taipei City 231, Taiwan, R.O.C.  
**Manufacturer** : SMART CABLING & TRANSMISSION CORP.  
**Address** : 10F, No.493, Chung-Cheng Rd., Hsin Tien Dist., New Taipei City 231, Taiwan, R.O.C.  
**EUT** : VGA to Video converter  
**Model Name** : VC0XXX (X=0~9,A~Z or space)  
**Model Differences** : N/A

**Measurement procedure used:**

<b>EMI :</b>	<b>EMS:</b>
EN55022 CLASS B: 2010	EN55024: 2010
EN61000-3-2:2006+A1:2009+A2:2009	IEC 61000-4-2 : 2008
EN 61000-3-3:2008	IEC 61000-4-3 : 2006+A1: 2007+A2:2010
	IEC61000-4-4: 2012
	IEC 61000-4-5 : 2005
	IEC 61000-4-6 : 2008
	IEC 61000-4-8 : 2009
	IEC 61000-4-11 : 2004

### Deviation from Applicable Standard

**According to the applicant's declaration this EUT is a class B product**

The above equipment was tested by PEP Certification Corp. for compliance with EMC requirements set forth in the EUROPEAN COUNCIL DIRECTIVE 2004/108/EC and the technical standards mentioned above. The results of testing in this report apply only to the product/system, which was tested. Other similar equipment will not necessarily produce the same results due to production tolerance.

This test report shall not be reproducing in part without written approval of PEP Certification Corp.

**Tested By:**

**Reviewed by:**

Sep. 30, 2013

**Date**

Benny Liu / Engineer

Sep. 30, 2013

**Date**

Alex Chou / Manager



## 1.1 DESCRIPTION OF THE TESTED SAMPLES

EUT

EUT Type :  Engineer Type

Condition when received :  Good  Damage :

EUT Name : VGA to Video converter

Model Number : VC0XXX

Receipt Date : 09/02/2013

EUT Power Rating :  AC Power

DC Power

DCV from PC

DCV from Adaptor

Input: 100-240Vac, 50/60Hz, 0.5A

Output: +5Vdc, 2A

I/O Port of EUT : DC In x 1

VGA in x1

VGA Out x1

Video In x1



**1.2 SUMMARY OF TEST RESULT**

<b>Emission</b>				
<b>Test Standard</b>	<b>Test Item</b>	<b>Test Result</b>		
EN55022 Class B	Conducted Emission	Pass		
EN55022 Class B	ISN	N/A		
EN55022 Class B	Radiated Emission	Pass		
EN61000-3-2	Harmonic	Pass		
EN61000-3-3	Flicker	Pass		
<b>Immunity</b>				
<b>Test Standard</b>	<b>Test Item</b>	<b>Performance Criteria</b>	<b>Observed Result Class</b>	<b>Test Result</b>
IEC61000-4-2	Electrostatic Discharge	B	A	Pass
IEC61000-4-3	Radiated Susceptibility	A	A	Pass
IEC61000-4-4	Electrical Fast Transient	B	A	Pass
IEC61000-4-5	Surge	B	A	Pass
IEC61000-4-6	Conducted Susceptibility	A	A	Pass
IEC61000-4-8	Magnetic Field	A	A	Pass
IEC61000-4-11	Voltage Dips and Interruption	Dips >95% B	A	Pass
		Dips 30% C	C	Pass
		Interruptions >95% C	C	Pass



**1.3 TEST METHODOLOGY**  
**EUT SYSTEM OPERATION**

1. The EUT was configured according to EN55022 CLASS B.
2. Photos of test configuration please refer to appendix 1.
3. Perform the EMC testing procedures, and measure the maximum emission noise.



## 1.4 DESCRIPTION OF THE SUPPORT EQUIPMENTS

### Setup Diagram

See test photographs attached in appendix 1 for the actual connections between EUT and support equipment.

### Support Equipment

Peripherals Devices:

OUTSIDE SUPPORT EQUIPMENT							
No.	Equipment	Model	Serial No.	FCC ID/ BSMI ID	Trade name	Data Cable	Power Cord
1.	PC	8985	L3C8543	R33B65	Lenovo	N/A	Unshielded 1.8m
2.	Monitor	P243WA	N/A	R3A002	Acer	Shielded 1.8m	Unshielded 1.8m
3.	Printer	D4360	N/A	R33001	HP	Shielded 1.8m	Unshielded 1.8m
4.	USB Flash	TS2GJFV30	156511-640 0	D33193	TRANSCEND	Shielded 1m	N/A
5.	Mouse	N889	N/A	R41101	DELL	Shielded 1.8m / USB	N/A
6.	Keyboard	SK-8185	N/A	T3A002	DELL	Shielded 1.8m / USB	N/A
7.	CRT Monitor	SMC-152F	N/A	N/A	SAMSUNG	N/A	Unshielded 1.8m

**Note:** All the above equipment /cable were placed in worse case position to maximize emission signals during emission test.

**Grounding:** Grounding was in accordance with the manufacturer's requirement and conditions for the intended use.

## 1.5 FEATURES OF EUT:PLEASE REFER TO USER MANUAL OR PRODUCT SPECIFICATION.



## 2. INSTRUMENT AND CALIBRATION

### 2.1 MEASURING INSTRUMENT CALIBRATION

The measuring equipment utilized to perform the tests documented in the report has been calibrated once a year or in accordance with the manufacturer's recommendations, and is traceable to recognized national standards.

### 2.2 TEST AND MEASUREMENT EQUIPMENT

The following list contains measurement equipment used for testing. The equipment conforms to the requirement of CISPR 16-1, ANSI C63.2 and. Other required standards.

Calibration of all test and measurement, including any accessories that may effect such calibration, is checked frequently to ensure the accuracy. Adjustments are made and correction factors are applied in accordance with the instructions contained in the respective.

**TABLELIST OF TEST AND MEASUREMENT EQUIPMENT**

Test Site	Instrument	Manufacturer	Model No.	S/N	Next Cal. Date
Conduction	Receiver	R&S	ESHS10	830223/008	Nov. 23, 2014
	Spectrum Analyzer	ADVANTEST	R3261C	87120343	Mar. 18, 2014
	RF Cable	MIYAZAKI & Anritsu	RG58A0 & MP59B	M79094	Apr. 08, 2014
	L.I.S.N	Rolf Heine Hochfrequenztec hnik	NNB-2/16z	98062	Jan. 16, 2014
	EMI Test Receiver	R&S	EAHS-10	1093.4495.03	Mar. 21, 2014
	Click Analyzer	Schaffner	DIA1512C	5218	June 15, 2014
Radiation	Spectrum Analyzer	Nex1	NS-265	NO5044006	Aug. 04, 2014
	Antenna	Schwarzbeck	VULB 9161	4077	Feb. 02, 2014
	RF Cable	N/A	N/A	N/A	Jan. 18, 2014
	Pre-Amp	Schaffner	CPA-9232	1012	Jan. 20, 2014
EMS	Harmonic/ Flicker	EMC-PARTNER	HAR-1000	066	Sep. 27, 2014
	ESD Simulator	NOISEKEN	ESS-2002	ESS0767151	Mar. 18. 2014



---

	EFT Noise Generator	EMC-PARTNER	TRANSIENT -2000	N/A	Sep. 03, 2014
	Surge Tester	EMC-PARTNET	TRANSIENT -2000	N/A	Mar. 17, 2014
	CDN	FRANKONIA	CDN M2+M3	A3011021	Nov. 23, 2014
	T4 CDN	FRANKONIA	CDN-RJ45	A3023011	Nov. 17, 2014
	Conducted Immunity Test System	FRANKONIA	CIT-10175	102C3117	Nov. 23, 2014

#: CALIBRATION INTERVAL OF INSTRUMENTS LISTED ABOVE IS ONE YEAR

### **2.3 TEST PERFORMED**

Conducted emissions were investigated over the frequency range from 0.15MHz to 30MHz using a receiver which resolution bandwidth is set at 9 KHz.

Radiated emissions were investigated over the frequency range from 30MHz to 1000MHz using a receiver which resolution bandwidth is set at 120KHz. Radiated measurement was performed at distance that from an antenna to EUT is 10meters.



## **2.4 APPENDIX**

### **Appendix A: Measurement Procedure for Main Power Port Conducted Emissions**

The measurements are performed in a PEP lab room; The EUT was placed on non-conductive 1.0m x 1.5m table, which is 0.8 meters above an earth-grounded.

Power to the EUT was provided through the LISN which has the Impedance (50ohm/50uH) vs. Frequency Characteristic in accordance with the standard. Powers to the LISNs were filtered to eliminate ambient signal interference and these filters were bonded to the ground plane. Peripheral equipment required to provide a functional system (support equipment) for EUT testing was powered from the second LISN through a ganged, metal power outlet box which is bonded to the ground plane at the LISN.

If the EUT is supplied with a flexible power cord, the power cord length in excess of the distance separating the EUT from the LISN shall be folded back and forth at the center of the lead so as to form a bundle not exceeding 40cm in length. If the EUT is provided with a permanently coiled power cord, bundling of the cord is not required. If the EUT is supplied without a power cord, the EUT shall be connected to the LISN by a power cord of the type specified by the manufacturer which shall not be longer than 1 meter. The excess power cord shall be bundled as described above. If a non-flexible power cord is provided with the EUT, it shall be cut to the length necessary to attach the EUT to the LISN and shall not be bundled.

The interconnecting cables were arranged and moved to get the maximum measurement. Both the line of power cord, hot and neutral, was measured.

The highest emissions were analyzed in details by operating the spectrum analyzer in fixed tuned mode to determine the nature of the emissions and to provide information which could be useful in reducing their amplitude.

### **Appendix B: Test Procedure for Radiated Emissions**

#### **Preliminary Measurements in the Anechoic Chamber**

The radiated emissions are initially measured in the anechoic chamber at a measurement distance of 3 meters. Desktop EUT are placed on a wooden stand 0.8 meter in height. The measurement antenna is 3 meters from the EUT. The test setup in anechoic chamber is the same as open site. The turntable rotated 360°C. The antenna height is 1m. The primary objective of the radiated measurements in the anechoic chamber is to identify the frequency spectrum in the absence of the electromagnetic environment existing on the open test site. The frequencies can then be pre-selected on the open test site to obtain the corresponding amplitude. The initial scan is made with the spectrum analyzer in automatic sweep mode. The spectrum peaks are then measured manually to determine the exact frequencies.



### **Measurements on the Open Site or Chamber**

The radiated emissions test will then be repeated on the open site or chamber to measure the amplitudes accurately and without the multiple reflections existing in the shielded room. The EUT and support equipments are set up on the turntable. Desktop EUT are set up on a wooden stand 0.8 meter above the ground.

For the initial measurements, the receiving antenna is varied from 1-4 meter height and is changed in the vertical plane from vertical to horizontal polarization at each frequency. Both reading are recorded with the quasi-peak detector with 120 KHz bandwidth. For frequency between 30 MHz and 1000MHz, the reading is recorded with peak detector or quasi-peak detector.

At the highest amplitudes observed, the EUT is rotated in the horizontal plane while changing the antenna polarization in the vertical plane to maximize the reading. The interconnecting cables were arranged and moved to get the maximum measurement. Once the maximum reading is obtained, the antenna elevation and polarization will be varied between specified limits to maximize the readings.

### 3. CONDUCTED EMISSION MEASUREMENT

#### 3.1 TEST SET-UP

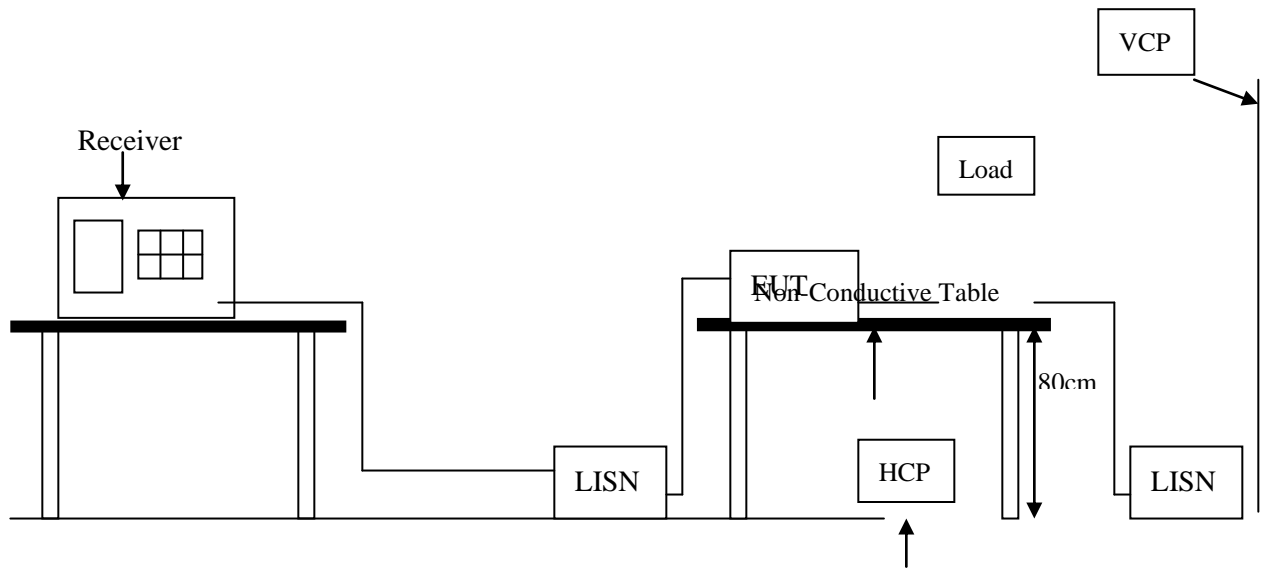

#### 3.2 LIMIT

Frequency range (MHz)	CLASS A		CLASS B	
	QP dB(uV)	Average dB(uV)	QP dB(uV)	Average dB(uV)
0.15-0.5	79 dBuV	66 dBuV	66 - 56 dBuV	56 - 46 dBuV
0.5-5.0	73 dBuV	60 dBuV	56 dBuV	46 dBuV
5.0-30.0	73 dBuV	60 dBuV	60 dBuV	50 dBuV

Remark: In the above table, the tighter limit applies at the band edges.

#### 3.3 TEST PROCEDURE

The EUT and simulators are connected to the main power through a line impedance stabilization network (LISN). It provides a 50 ohm / 50  $\mu$ H coupling impedance for the measuring equipment. The peripheral devices are also connected to the main power through a LISN that provides a 50 ohm / 50  $\mu$ H coupling impedance with 50 ohm termination. (Please refer to the block diagram of the test setup and photograph.)

Both sides of AC line are checked for the maximum conducted emission interference. In order to find the maximum emissions, the relating positions of equipment and all of the interference cables must be changed according to EN 55022 regulation: The measurement procedure on conducted emission interference.

The resolution bandwidth of the field strength meter is set at 9 KHz



**3.4 TEST SPECIFICATION**

According to EN 55022

(Please refer to Page 4 for dated references which are related to the standard as mentioned above)

**3.5 RESULT: PASSED**

EMI Receiver/Spectrum Analyzer Configuration (for the frequencies tested)

Frequency Range:	150KHz--30MHz
Detector Function:	Quasi-Peak / Average Mode
Resolution Bandwidth:	9KHz

**3.6 TEST DATA:**

**Please refer to appendix 2**

**4. RADIATED EMISSION MEASUREMENT**  
**4.1 TEST SETUP**

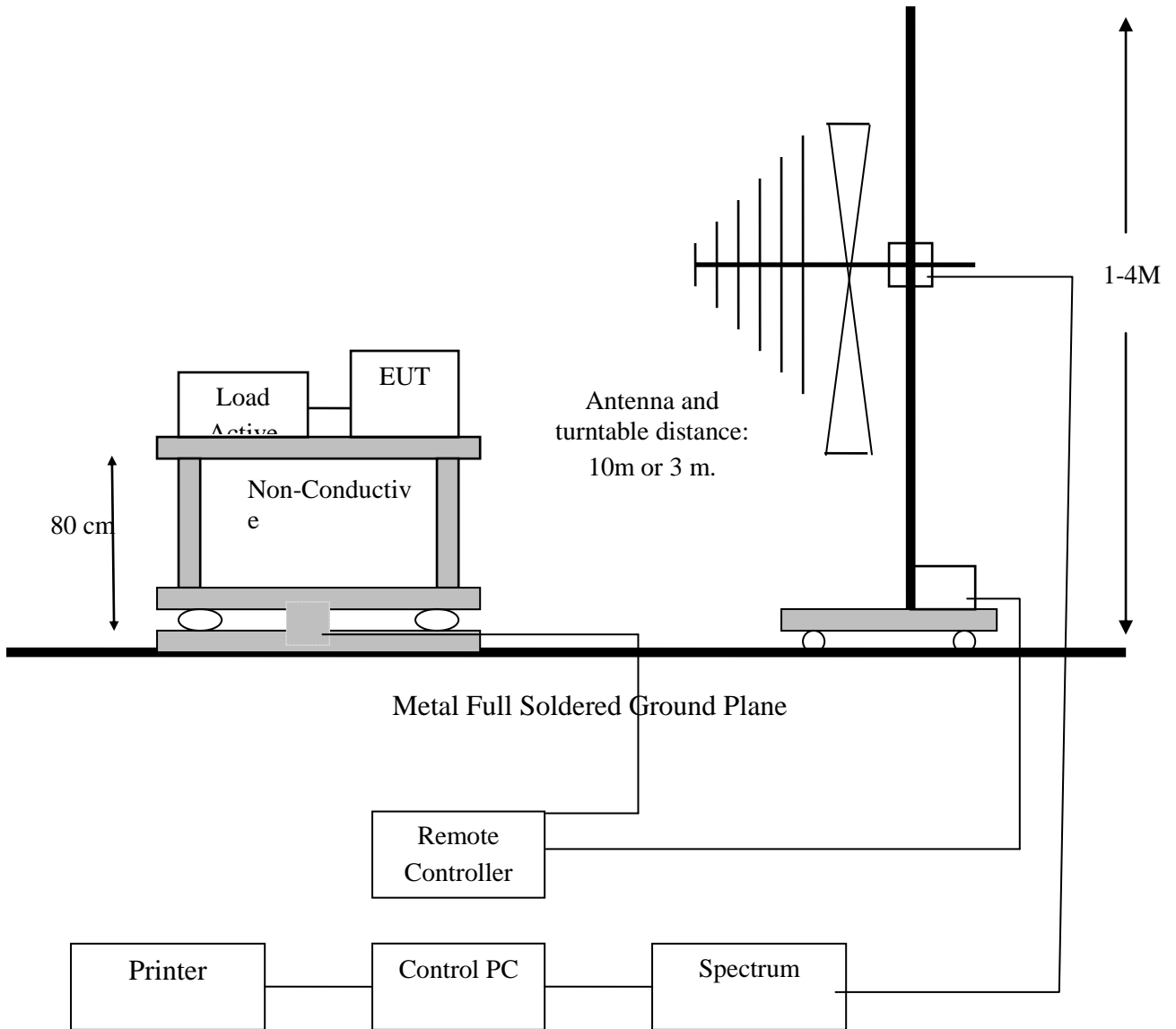



#### 4.2 LIMIT

Frequency	Class A		Class B	
MHz	Distance (Meter)	Limit dB $\mu$ V/m	Distance (Meter)	Limit dB $\mu$ V/m
30 ~ 230	10	40	10	30
230 ~ 1000	10	47	10	37

For Class A

Frequency range GHz	Average limit dB( $\mu$ V/m)	Peak limit dB( $\mu$ V/m)
1 to 3	56	76
3 to 6	60	80
NOTE The lower limit applies at the transition frequency.		

For Class B

Frequency range GHz	Average limit dB( $\mu$ V/m)	Peak limit dB( $\mu$ V/m)
1 to 3	50	70
3 to 6	54	74
NOTE The lower limit applies at the transition frequency.		

Remark: In the above table, the tighter limit applies at the band edges.

#### 4.3 TEST PROCEDURE

The EUT and its simulators are placed on turn table, non-conductive and wooden table, which is 0.8 meter above ground. The turn table rotates 360 degrees to determine the position of the maximum emission level. The EUT was positioned such that distance from antenna to the EUT is 10 meters.

The antenna is moved up and down between 1 meter and 4 meters to receive the maximum emission level.

Both horizontal and vertical polarizations of the antenna are set on measurement. In order to find the maximum emission, all of the interference cables must be manipulated according to EN 55022 regulations: the test procedure of the radiated emission measurement.

The bandwidth set on the field strength is 120 KHz when the frequency range is below 1GHz.



**4.4 TEST SPECIFICATION**

According to EN 55022 CLASS B

(Please refer to Page 4 for dated references which are related to the standard as mentioned above)

**4.5 RESULT: PASSED**

**4.6 TEST DATA:**

**Please refer to appendix 2**

## 5. POWER HARMONIC MEASUREMENT

### 5.1 TEST SETUP

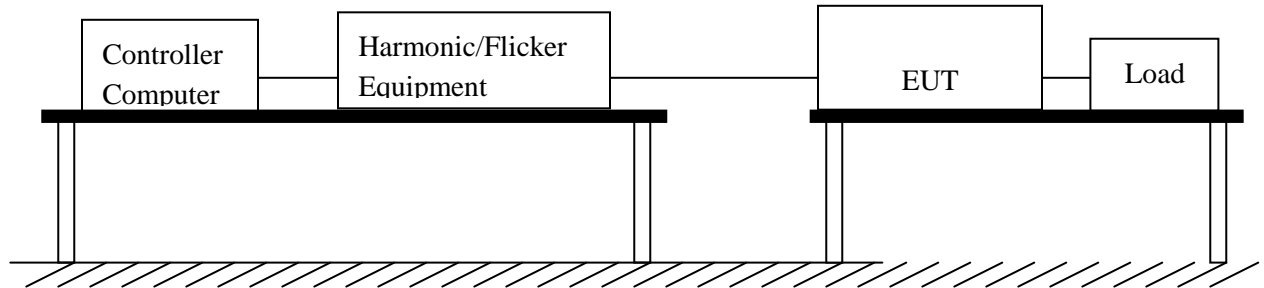

### 5.2 LIMIT OF HARMONIC CURRENT

Limit of Harmonic Currents

Harmonic Order	Maximum Permissible Harmonic Current (Ampere)	Harmonic Order	Maximum Permissible Harmonic Current (Ampere)
Odd Harmonic		Even Harmonic	
3	2.30	2	1.08
5	1.14	4	0.43
7	0.77	6	0.30
9	0.40	8 ≤ n ≤ 40	0.23 x 8/n
11	0.33		
13	0.21		
15 ≤ n ( 39)	0.15 x 15/n		

### 5.3 TEST PROCEDURE

The EUT is supplied in series with power analyzer from a power source has the same normal voltage and frequency as the rated supply voltage and the equipment under test. The rated voltage at the supply voltage of EUT of 0.94 time and 1.06 times shall be performed.

### 5.4 TEST SPECIFICATION

According to EN 61000-3-2

(Please refer to Page 4 for dated references which are related to the standard as mentioned above)

### 5.5 RESULT: PASSED

### 5.6 TEST DATA:

Please refer to appendix 2

## 6. VOLTAGE FLUCTUATIONS

### 6.1 TEST SETUP

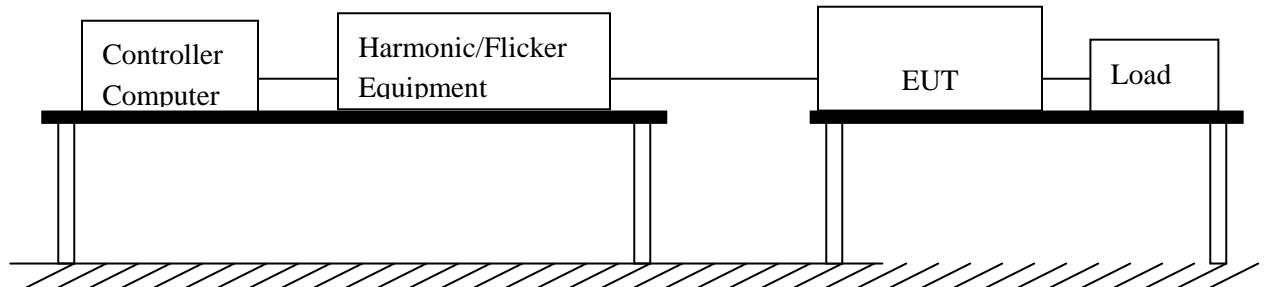

### 6.2 VOLTAGE FLUCTUATIONS TEST

Port:	AC mains
Basic Standard:	EN61000-3-3
Test Procedure	Refer to paragraph 6.3
Observation period:	For Pst 10min
	For Plt 2 hours

### 6.3 TEST PROCEDURE

The EUT is supplied in series with reference impedance from a power source with the voltage and frequency as the nominal supply voltage and frequency of the EUT.

### 6.4 TEST SPECIFICATION

According to EN 61000-3-3

According to EN55022 CLASS B

(Please refers to Page 4 for dated references which are related to the standard as mentioned above)

### 6.5 RESULT: PASSED

### 6.6 TEST DATA:

Please refer to appendix 2

## 7. ELECTROSTATIC DISCHARGE IMMUNITY TEST (ESD)

### 7.1 TEST PROCEDURE

According To IEC 61000-4-2

According To EN 55024

( Please refer to Page 4 for dated references which are related to the standard as mentioned above)

### 7.2 TEST SETUP

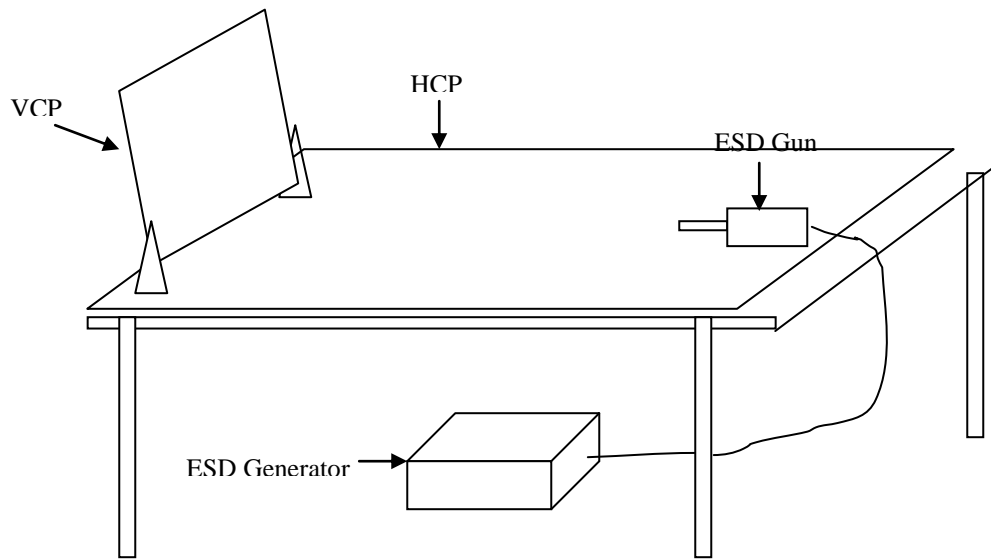

### 7.3 TEST LEVEL

Item	Test Specification	Unit	Performance Criteria
Enclosure Room	±2, 4, 8 (Air Discharge)	KV (Charge Voltage)	B
Electrostatic Discharge	±2,4 (Contact Discharge)		
<b>Time between test</b>	<u>1</u>	sec	

Number of test: 10 Discharges / Test point / Polarity / Level

Particular requirements: at least 200 discharges, 100 each at negative and positive polarity, at a minimum of four test points.

When the measurement was taken, The ESD discharger was performed in single discharge. For the single discharge time between successive single discharges will keep on one second. It was at least ten single discharges with positive and negative at the same selected pointed. The selected pointed, which was performed with electrostatic discharge, was marked on the red label on the EUT Indirect applicant of discharge to the EUT

Vertical Coupling Plane (VCP)



The coupling plane, of dimensions 0.5m x 0.5m, is placed parallel to, and positioned at a distance 0.1m from, the EUT, with the discharge electrode touching the coupling plane.

The four faces of the EUT will be performed with electrostatic discharge. It was at least ten singles discharges with positive and negative at the same selected point.

**Horizontal Coupling Plane (HCP)**

The coupling plane is placed under the EUT. The generator shall be positioned vertically at a distance of 0.1m from the EUT, with the discharge electrode touching the coupling.

The four faces of the EUT will be performed with electrostatic discharge. It was at least ten single discharges with positive and negative at the same selected pointed.

**7.4 TEST RESULT.**

Model: VC0XXX

Temperature: 25°C , Humidity: 43 % RH

<b>Test Item : Direct Discharge</b>															
<b>Contact Discharge</b>								<b>Air Discharge</b>							
<b>2KV</b>		<b>4KV</b>		<b>KV</b>		<b>KV</b>		<b>2KV</b>		<b>4KV</b>		<b>6KV</b>		<b>8KV</b>	
<b>+</b>	<b>-</b>	<b>+</b>	<b>-</b>	<b>+</b>	<b>-</b>	<b>+</b>	<b>-</b>	<b>+</b>	<b>-</b>	<b>+</b>	<b>-</b>	<b>+</b>	<b>-</b>	<b>+</b>	<b>-</b>
A	A	A	A	/	/	/	/	/	/	/	/	/	/	/	/
<b>Test Item : Indirect Discharge</b>															
<b>Contact Discharge</b>															
	<b>2KV</b>		<b>4KV</b>		<b>KV</b>		<b>KV</b>								
	<b>+</b>	<b>-</b>	<b>+</b>	<b>-</b>	<b>+</b>	<b>-</b>	<b>+</b>	<b>-</b>							
1	A	A	A	A	/	/	/	/							

Test points please refer below photos:



Red Dot: Contact



**Performance Criteria:**

- A) Normal performance within the specification;
- B) Temporary degradation or less of function of performance which is self recoverable;
- C) Temporary degradation or less of function or perform. Which requires. operate intervention or system reset;
- D) Degradation or loss of function which is not recoverable due to damage of equipment (components) or software, or loss of data;

"/" : no test.

Final Result: **PASSED**

Remark:

**Photos of test configuration please refer to appendix 1.**

## 8. RADIATED SUSCEPTIBILITY MEASUREMENT (RS)

### 8.1 TEST SETUP

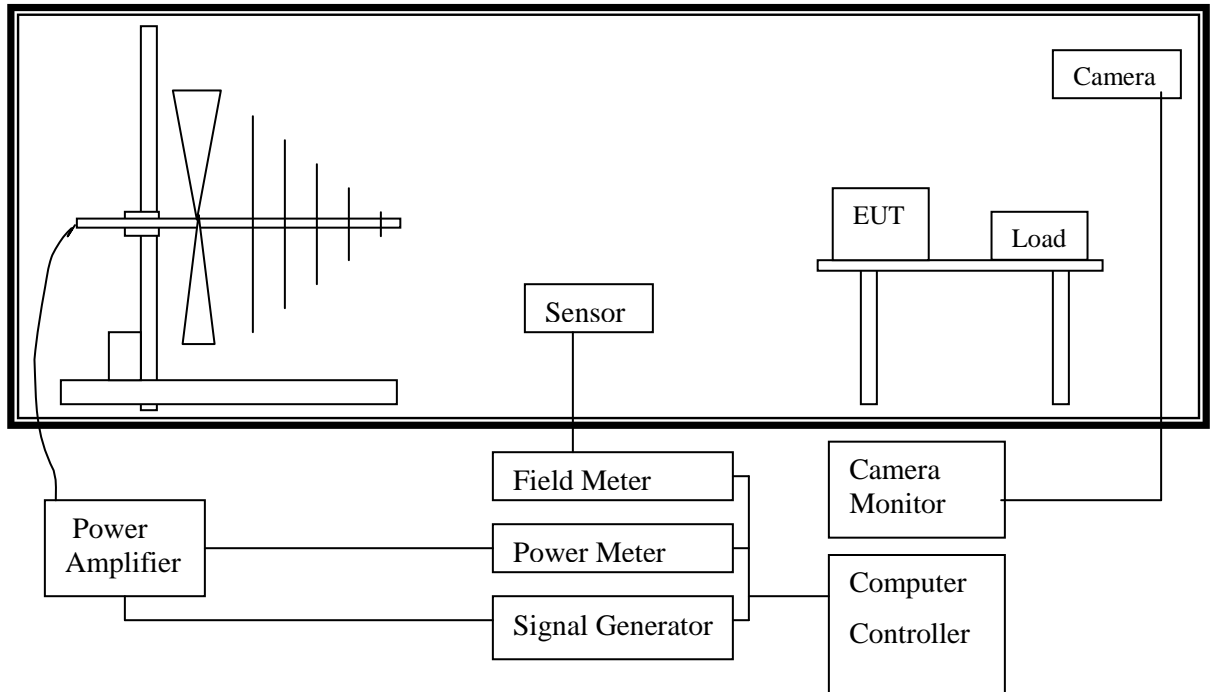

### 8.2 TEST PROCEDURE

According To IEC 61000-4-3

According To EN 55024

(Please refer to Page 4 for dated references which are related to the standard as mentioned above)

### 8.3 TEST LEVEL

Item	Test Specification	Unit	Performance Criteria
Radio –Frequency	80~1000	MHz	A
Electromagnetic Field	3	V/m (unmodulated, rms)	
Amplitude Modulated	80	%AM (1KHz)	



### 8.4 TEST PROCEDURE

The EUT and load, which are placed on a wooden table whose height is 0.8 meter aboveground, are placed with one coincident with the calibration plane such that the distance from antenna to the EUT is 3 meters.

Both horizontal and vertical polarization of the antenna position and four sides of the EUT are set on measurement. In order to judge the EUT performance, a CCD camera is used to monitor the situation of EUT.

All the scanning conditions are as follows:

Condition of Test	Remarks
1. Field Strength	3V/m; Level 2
2. Radiated Signal	AM 80% modulated with 1KHz
3. Scanning Frequencies	80MHz ~ 1000MHz
4. Dwell Time	3 seconds
5. Frequency step size	1%
6. The rate of swept of frequency	$1.5 \times 10^{-3}$ decades/s
7. Antenna Polarity	HORIZONTAL & VERTICAL
8. The four sides of EUT are tested	FRONT, REAR, RIGHT, LEFT

### 8.5 TEST RESULT

Model: VC0XXX

Temperature: 25°C , Humidity: 43 % RH

ANT SIDE	3V HORIZONTAL	3V VERTICAL	RESULT
FRONT	A	A	<b>PASSED</b>
REAR	A	A	<b>PASSED</b>
RIGHT	A	A	<b>PASSED</b>
LEFT	A	A	<b>PASSED</b>

Performance Criteria:

- A) Normal performance within the specification;
  - B) Temporary degradation or less of function of performance which is self recoverable;
  - C) Temporary degradation or less of function or perform. Which requires. operate intervention or system reset;
  - D) Degradation or loss of function which is not recoverable due to damage of equipment (components) or software, or loss of data;
- "/" : no test.

Final Result: **PASSED**

Remark:

**Photos of test configuration please refer to appendix 1.**

## 9. ELECTRICAL FAST TRANSIENT/BURST (EFT)

### 9.1 TEST SETUP

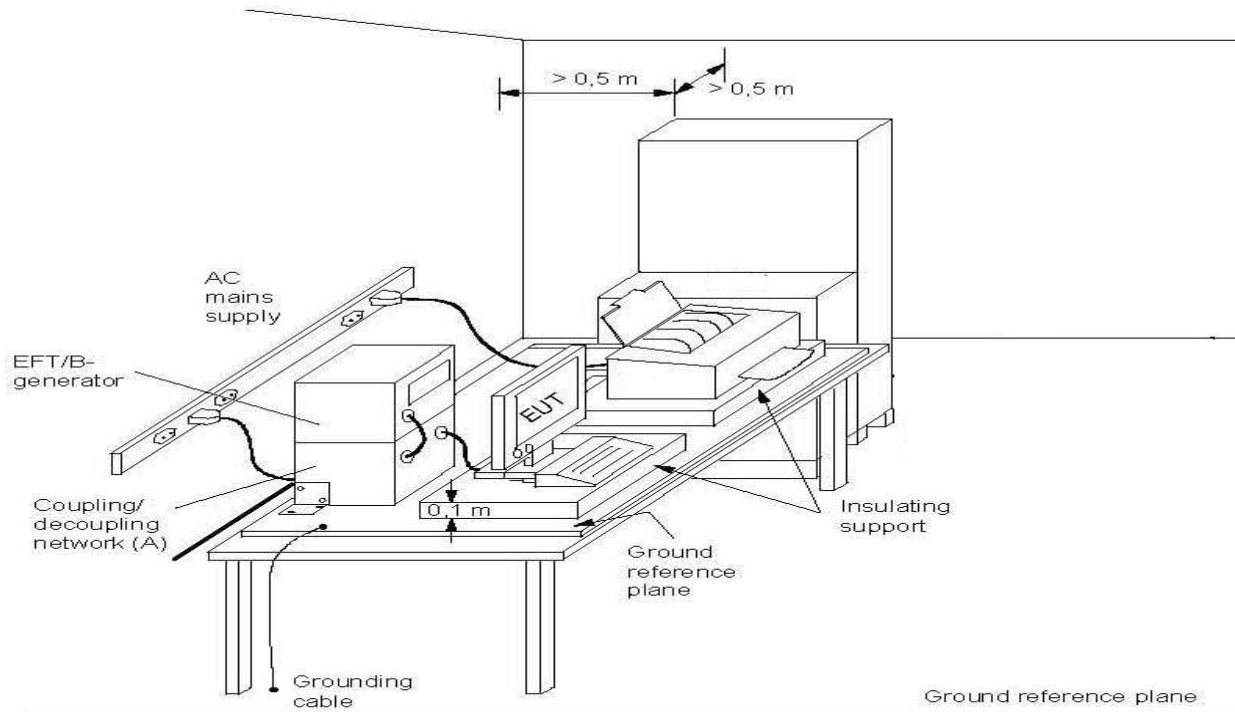

### 9.2 TEST PROCEDURE

According To IEC 61000-4-4

According To EN 55024

(Please refer to Page 4 for dated references which are related to the standard as mentioned above)

### 9.3 TEST PROCEDURE

The EUT and load are placed on a ground reference plane and insulated from it by an insulating support  $0,1\text{ m} \pm 0,01\text{ m}$  thick. The minimum area of the ground reference plane is  $1\text{ m} \times 1\text{ m}$ . It also projected beyond the EUT by at least 0.1meter on all sides.

For Input and Output AC power or DC Input and DC Output Power Ports:

The EUT is connected with the power mains through a coupling device that directly couples the EFT interference signal.

Each of the line and nature conductors is impressed with burst noise for 1 minute.

For Protective Earth Port:

The EUT is connected to the power mains through a coupling device that directly couples the EFT interference signal. The protective earth line (PE) is impressed with burst noise for 1 minute.

The length of power cord between the coupling device and the EUT shall be  $0.5\text{ m} \pm 0.05\text{ m}$ .

For signal Lines and Control Lines Test:

The EFT interference signal is through a coupling clamp device couples to the signal and control lines of the EUT with burst noise for 1 minute.



**9.4 TEST LEVEL**

Item	Test Specification	Unit	Performance Criteria
Test Voltage	±0.5, ±1	KV (Peak)	B
Pulse Rise time & Duration	5/50	Tr/Ts (ns)	
Pulse Repetition	5	Rep. Frequency (KHz)	

**9.5 TEST RESULT**

Model: VC0XXX

Temperature: 25°C , Humidity: 43 % RH

Test Point/ Mode / Result		0.5 KV		1 KV		2 KV	
		+	-	+	-	+	-
<b>Power Line</b>	<b>L</b>	A	A	A	A	/	/
	<b>N</b>	A	A	A	A	/	/
	<b>G</b>	/	/	/	/	/	/
<b>Signal Line Clamp Test</b>		/	/	/	/	/	/

**Performance Criteria:**

- A) Normal performance within the specification;
- B) Temporary degradation or less of function of performance which is self recoverable;
- C) Temporary degradation or less of function or perform. Which requires. operate intervention or system reset;
- D) Degradation or loss of function which is not recoverable due to damage of equipment (components) or software, or loss of data;

"/" : no test.

Final Result: **PASSED**

Remark:

**Photos of test configuration please refer to appendix 1.**

## 10. SURGE

### 10.1 TEST SETUP

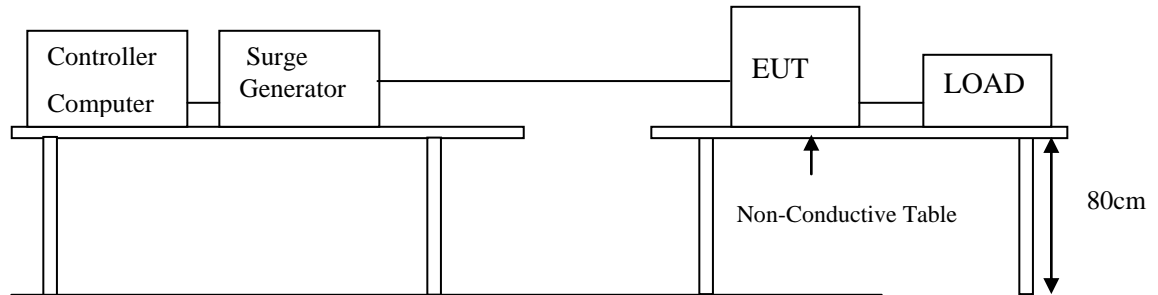

### 10.2 TEST PROCEDURE

According To IEC 61000-4-5

According To EN 55024

(Please refer to Page 4 for dated references which are related to the standard as mentioned above)

### 10.3 TEST LEVEL

Item	Test Specification	Unit	Performance Criteria
DC Input and DC Output Power Ports			
Surge	1.2/50(8/20)	Tr/Ts (µs)	B
Line to Ground	±0.5	KV	
Line to Line	±0.5	KV	
AC Input and AC Output Power Ports			
Surge	1.2/50(8/20)	Tr/Ts (µs)	B
Line to Ground	±2	KV	
Line to Line	±1	KV	
Polarity	POSITIVE / NEGATIVE		
Phase shifting in a range between 0°to 360°			



### 10.4 TEST PROCEDURE

The EUT and its load are placed on a table which is 0.8 meter height. The length of power cord between the coupling device and the EUT shall be 2 meters or less.

For Input and Output AC Power or DC Input and DC Output Power Ports:

The EUT is connected to the power mains through a coupling device that directly couples the Surge interference signal.

The Surge noise shall be applied synchronized to the voltage phase at 0°, 90°, 180°, 270° and the peak value of the AC voltage wave. (5 Positive and 5 Negative)

Each of line-earth and line-line is impressed with a sequence of five surge voltages with interval of 1 minute.

### 10.5 TEST RESULT

Model: VC0XXX

Temperature: 25°C , Humidity: 43 % RH

Phase/Polarity/Mode/Result			0	90	180	270
Power Line 1KV	Line	+	A	A	A	A
	Neutral	-	A	A	A	A
Signal Line 2KV	Line	+	/	/	/	/
	Neutral	-	/	/	/	/
Power Line 2KV	Line	+	/	/	/	/
	Ground	-	/	/	/	/
	Neutral	+	/	/	/	/
	Ground	-	/	/	/	/

#### Performance Criteria:

- A) Normal performance within the specification;
- B) Temporary degradation or less of function of performance which is self recoverable;
- C) Temporary degradation or less of function or perform. Which requires. operate intervention or system reset;
- D) Degradation or loss of function which is not recoverable due to damage of equipment (components) or software, or loss of data;

"/" : no test.

Final Result: **PASSED**

Remark:

**Photos of test configuration please refer to appendix 1.**

## 11. IMMUNITY TEST TO CS CONDUCTED DISTURBANCE (CS)

### 11.1 TEST SETUP

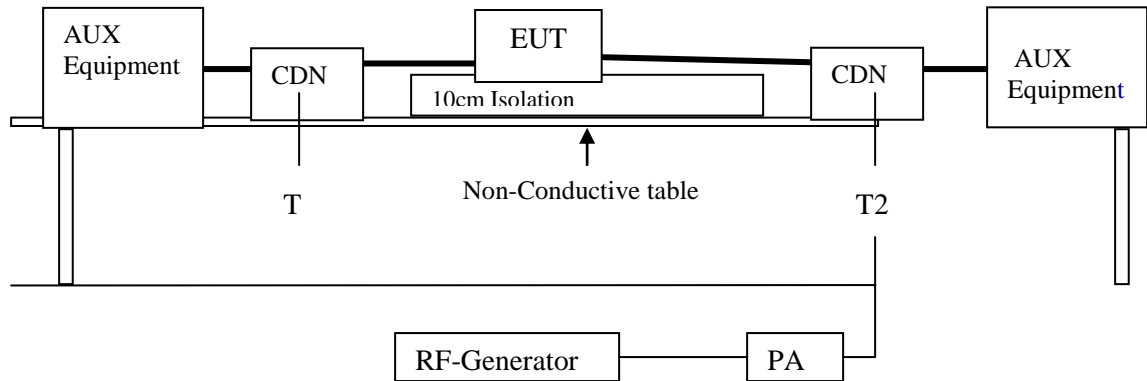

### 11.2 TEST PROCEDURE

According To IEC 61000-4-6

According To EN 55024

(Please refer to Page 4 for dated references which are related to the standard as mentioned above)

### 11.3 TEST LEVEL

Item	Test Specification	Unit	Performance Criteria
Ports for Signal Lines			
Radio-Frequency	0.15 ~ 80	MHz	A
Common Mode	3	V (rms, Unmodulated)	
Amplitude Modulated	80	%AM (1KHz)	
	150	Source Impedance	
Ac Input and AC Output and DC Input and DC output Ports and Functional Earth Ports			
Radio-Frequency	0.15 ~ 80	MHz	
Common Mode	3	V (rms, Unmodulated)	A
Amplitude Modulated	80	%AM (1KHz)	
	150	Source Impedance	



### 11.4 TEST PROCEDURE

The EUT are placed on a table which is 0.8 meter height and a ground reference plane on the table, the EUT are placed upon table and use 10cm insulation between the EUT and ground reference plane.

For AC Input and AC Output Power or DC Input and DC Output Power Ports

The EUT is connected to the power mains through a coupling and decoupling networks for Power supply lines. It also directly couples the disturbance signal into EUT.

Use CDN-M2 for two wires or CDN-M3 for three wires.

For Signal Lines and Control Lines Test:

The disturbance signal is through a coupling and decoupling networks (CDN) or EM-clamp which is to couple the signal and control lines of the EUT.

All scanning frequencies conditions are as following:

Condition of Test	Remarks
IEC 61000-4-6	
1. Field Strength	3V; Level 2
2. Radiated Signal	AM 80% modulated with 1KHz
3. Scanning Frequencies	0.15MHz ~ 80MHz
4. Dwell Time	3 seconds
5. Frequency step size $\Delta f$	1%
6. The rate of swept of frequency	$1.5 \times 10^{-3}$ decades/s

### 11.5 TEST RESULT

Model: VC0XXX

Temperature: 25°C , Humidity: 43 % RH

TEST Specification	Unit	Performance Criteria
0.15 - 80	MHz	A
3	V	
80	% AM (1KHz)	

Performance Criteria:

- A) Normal performance within the specification;
- B) Temporary degradation or less of function of performance which is self recoverable;
- C) Temporary degradation or less of function or perform. Which requires. operate intervention or system reset;
- D) Degradation or loss of function which is not recoverable due to damage of equipment (components) or software, or loss of data;

"/" : no test.



Final Result: **PASSED**

Remark:

**Photos of test configuration please refer to appendix 1.**

## 12. POWER FREQUENCY MAGNETIC FIELD (MAGNETIC)

### 12.1 TEST SETUP

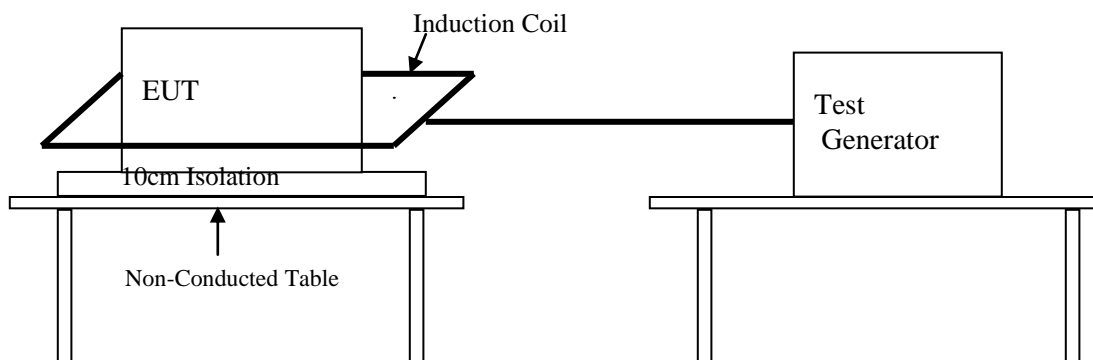

### 12.2 TEST STANDARD

According To IEC 61000-4-8

According To EN 55024

(Please refer to Page 4 for dated references which are related to the standard as mentioned above)

### 12.3 TEST LEVEL

Item	Test Specification	Unit	Performance Criteria
Power-Frequency	50	Hz	A
Magnetic Field	1	A/m	

### 12.4 TEST PROCEDURE

The EUT and its load are placed on a table that is 0.8 meter above the metal ground plane dimension is at least 1 meter x 1 meter. The test magnetic field shall be placed at least than 3 meter distance from the induction coil.

The test magnetic field shall be applied by the immersion method to the EUT. The induction coil shall be rotated by 90° in order to expose the EUT to the test field with different orientation (X, Y, Z orientation).



## 12.5 TEST RESULT

Model: VC0XXX

Temperature: 25°C , Humidity: 43 % RH

Environmental Phenomena	Test Specification	Units	Performance Criteria
Magnetic Field	1	A/m	A

### Performance Criteria:

- A) Normal performance within the specification;
  - B) Temporary degradation or less of function of performance which is self recoverable;
  - C) Temporary degradation or less of function or perform. Which requires. operate intervention or system reset;
  - D) Degradation or loss of function which is not recoverable due to damage of equipment (components) or software, or loss of data;
- "/" : no test.

Final Result: **PASSED**

Remark:

**Photos of test configuration please refer to appendix 1.**

## 13. VOLTAGE DIPS AND INTERRUPTION MEASUREMENT

### 13.1 TEST SETUP

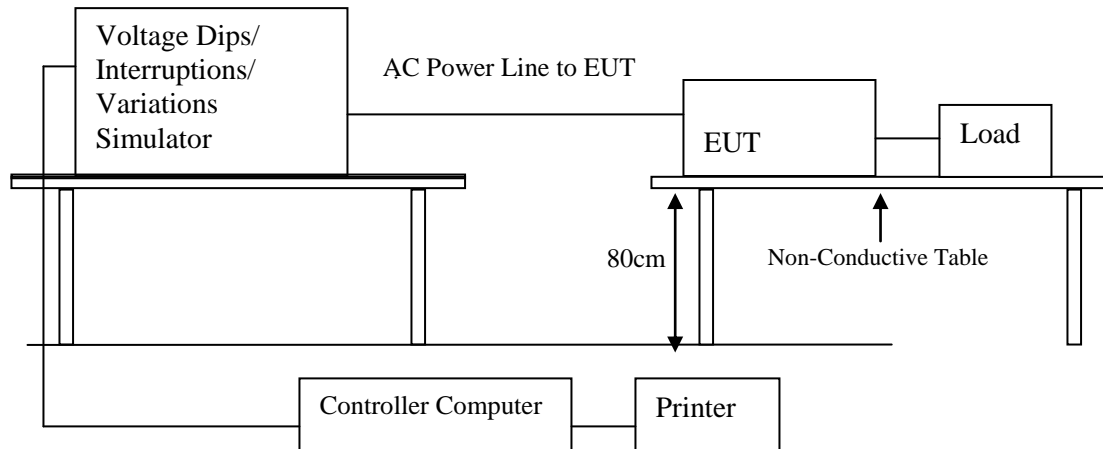

### 13.2 TEST PROCEDURE

According To IEC 61000-4-11

According To EN 55024

(Please refer to Page 4 for dated references which are related to the standard as mentioned above)



### 13.3 TEST LEVEL

Class <sup>a</sup>	Test level and durations for voltage dips				
Class 1	Case-by-case according to the equipment requirements				
Class 2	0 % during 1/2 cycle	0 % during 1 cycle	70 % during 25/30 <sup>c</sup> cycles		
Class 3	0 % during 1/2 cycle	0 % during 1 cycle	40 % during 10/12 <sup>c</sup> cycles	70 % during 25/30 <sup>c</sup> cycles	80 % during 250/300 <sup>c</sup> cycles
Class X <sup>b</sup>	X	X	X	X	X

a: Classes as per IEC 61000-2-4.

b: To be defined by product committee. For equipment connected directly or indirectly to the public network, the levels must not be less severe than Class 2.

c: "25/30 cycles" means "25 cycles for 50 Hz test" and "30 cycles for 60 Hz test".

Class <sup>a</sup>	Test level and durations for short interruptions (t <sub>s</sub> ) (50Hz / 60Hz)
Class 1	Case-by-case according to the equipment requirements
Class 2	0 % during 250/300 <sup>c</sup> cycles
Class 3	0 % during 250/300 <sup>c</sup> cycles
Class X <sup>b</sup>	X

a: Classes as per IEC 61000-2-4.

b: To be defined by product committee. For equipment connected directly or indirectly to the public network, the levels must not be less severe than Class 2.

c: "250/300 cycles" means "250 cycles for 50 Hz test" and "300 cycles for 60 Hz test".

### 13.4 TEST PROCEDURE

The EUT and its load are placed on a wooden table which is 0.8 meter above a metal ground plane which dimension is 1 meter x 1 meter, the thickness is 0.65mm. It projected beyond the EUT by at least 0.1 meter on all sides. The power cord shall be used the shortest power cord as specified by the manufacturer.

For Voltage Dips / Interruption Test:

The EUT is connected to the power mains through a coupling device that directly couples to the Voltage Dips and Interruption Generator.

The EUT shall be tested for 30% voltage dips of supplied voltage and duration time is 10ms, for 60% voltage dips of supplied voltage and duration time is 100ms with a sequence of three voltage dips with intervals of 10 seconds, and for 95% voltage interruption of supplied voltage and the duration time is 5000ms with a sequence of three voltage interruptions with intervals of 10 seconds.

Voltage phase shifting shall occur at 0°, 45°, 90°, 135°, 180°, 225°, 270°, 315° of the voltage.



### 13.5 TEST RESULT

Model: VC0XXX

Temperature: 25°C , Humidity: 43 % RH

Voltage Dips	Test Level % U <sub>T</sub>	Reduction (%)	Duration	Performance Criteria
	<5	>95	0.5 (periods)	A
	70	30	25 (periods)	C

Voltage Dips	Test Level % U <sub>T</sub>	Reduction (%)	Duration	Performance Criteria
	70	30	10ms	A
	40	60	100 and 1000ms	C

Voltage Dips	Test Level % U <sub>T</sub>	Reduction (%)	Duration	Performance Criteria
	<5	>95	250(periods) 5000ms	C

**Performance Criteria:**

- A) Normal performance within the specification;
  - B) Temporary degradation or less of function of performance which is self recoverable;
  - C) Temporary degradation or less of function or perform. Which requires. operate intervention or system reset;
  - D) Degradation or loss of function which is not recoverable due to damage of equipment (components) or software, or loss of data;
- "/" : no test.

Final Result: **PASSED**

Remark:

**Please refer to appendix 2.**



## **14. PERFORMANCE CRITERIA**

- A. The apparatus shall continue to operate as intended during and after the test. No degradation of performance or loss of function is allowed below a performance level specified by the manufacturer, when the apparatus is used as intended.
- B. The apparatus shall continue to operate as intended after the test. No degradation of performance or loss of function is allowed below a performance level specified by the manufacturer, when the apparatus is used as intended. The performance level may be replaced by a permissible loss of performance. During the test, degradation of performance is however allowed.
- C. Temporary loss of function is allowed, provided the function is self-recoverable or can be restored by the operation of the controls.



**15. MEASUREMENT UNCERTAINTY**

Measurement Item	Measurement Frequency	Polarization	Uncertainty
Conducted Emission	9 kHz ~ 30. MHz	LINE/NEUTRAL	1.78 dB
Radiated Emission	30 MHz ~ 1,000 MHz	Vertical / Horizontal	1.96 dB
	1,000 MHz ~ 6,000 MHz	Vertical / Horizontal	3.00 dB

## **Appendix 1**

### **PHOTOS OF TEST CONFIGURATION**

01 CE Front View



02 CE Rear View



03 RE Front View



04 RE Rear View



05 Harmonics & Flicker & Surge & DIPS



06 ESD



07 RS



08 EFT



09 CS



10 PFMF



**Appendix 2**  
**TEST DATA**



Data: 1

File: D:\CON數據\案件數據\13090307\13090307-CON.EM6 (4)

Date: 2013-09-25 Time: 21:34:33

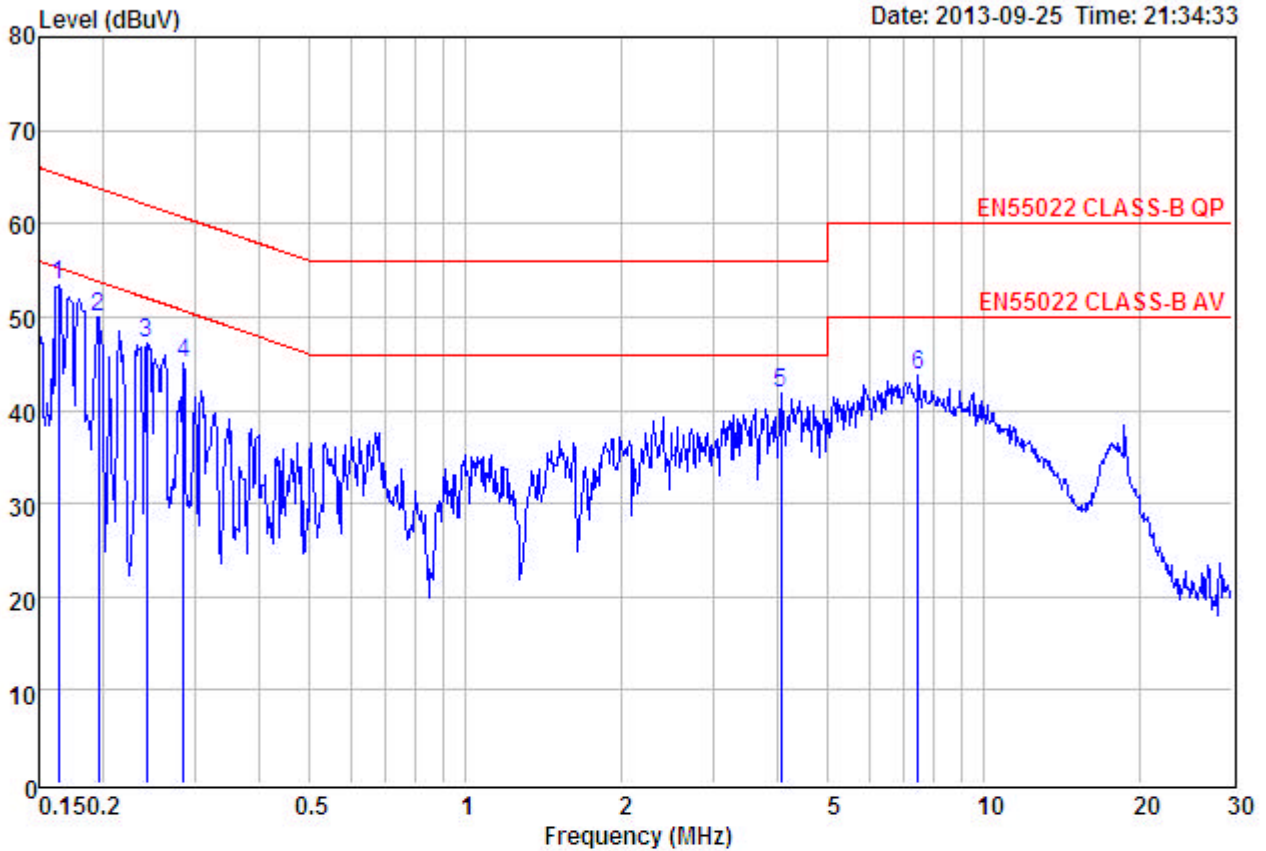

Site : Conduction  
 Condition : EN55022 CLASS-B QP CON-LISN(103) LINE  
 EUT : Please refer to page 1 of report  
 MODEL : AFS8210M  
 MEMO : WORKING 1280\*1024  
 T/H : AC 230V

Remarks: : Factor=Insertion loss+Cable loss

	Freq	Read Level	Level	Factor	Over Limit	Limit Line	Remark
	MHz	dBuV	dBuV	dB	dB	dBuV	
1	0.16	53.25	53.39	0.14	-11.91	65.30	Peak
2	0.20	49.90	50.04	0.14	-13.76	63.80	Peak
3	0.24	47.11	47.25	0.14	-14.79	62.04	Peak
4	0.28	44.95	45.10	0.15	-15.58	60.68	Peak
5	4.05	41.36	41.78	0.42	-14.22	56.00	Peak
6	7.45	43.26	43.83	0.57	-16.17	60.00	Peak



Data: 2

File: D:\CON數據\案件數據\13090307\13090307-CON.EM6 (4)

Date: 2013-09-25 Time: 21:35:57

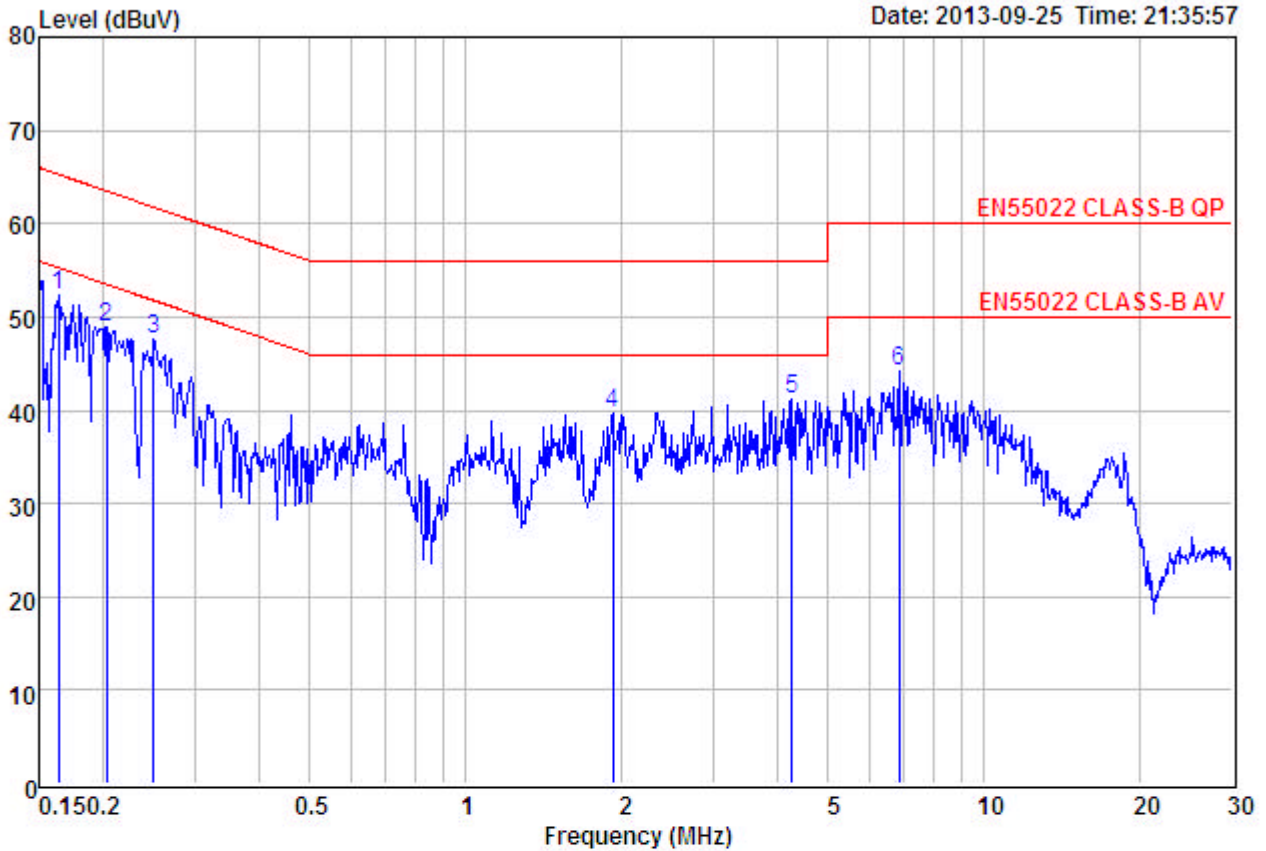

Site : Conduction  
 Condition : EN55022 CLASS-B QP CON-LISN(103) NEUTRAL  
 EUT : Please refer to page 1 of report  
 MODEL : AFS8210M  
 MEMO : WORKING 1280\*1024  
 T/H : AC 230V

Remarks: : Factor=Insertion loss+Cable loss

	Freq	Read Level	Level	Factor	Over Limit	Limit Line	Remark
	MHz	dBuV	dBuV	dB	dB	dBuV	
1	0.16	52.18	52.32	0.14	-12.98	65.30	Peak
2	0.20	48.81	48.94	0.13	-14.55	63.49	Peak
3	0.25	47.41	47.54	0.13	-14.24	61.78	Peak
4	1.92	39.44	39.72	0.28	-16.28	56.00	Peak
5	4.25	40.73	41.15	0.42	-14.85	56.00	Peak
6	6.84	43.75	44.27	0.52	-15.73	60.00	Peak



Data: 3

File: D:\CON數據\案件數據\13090307\13090307-CON.EM6 (4)

Date: 2013-09-25 Time: 21:45:26

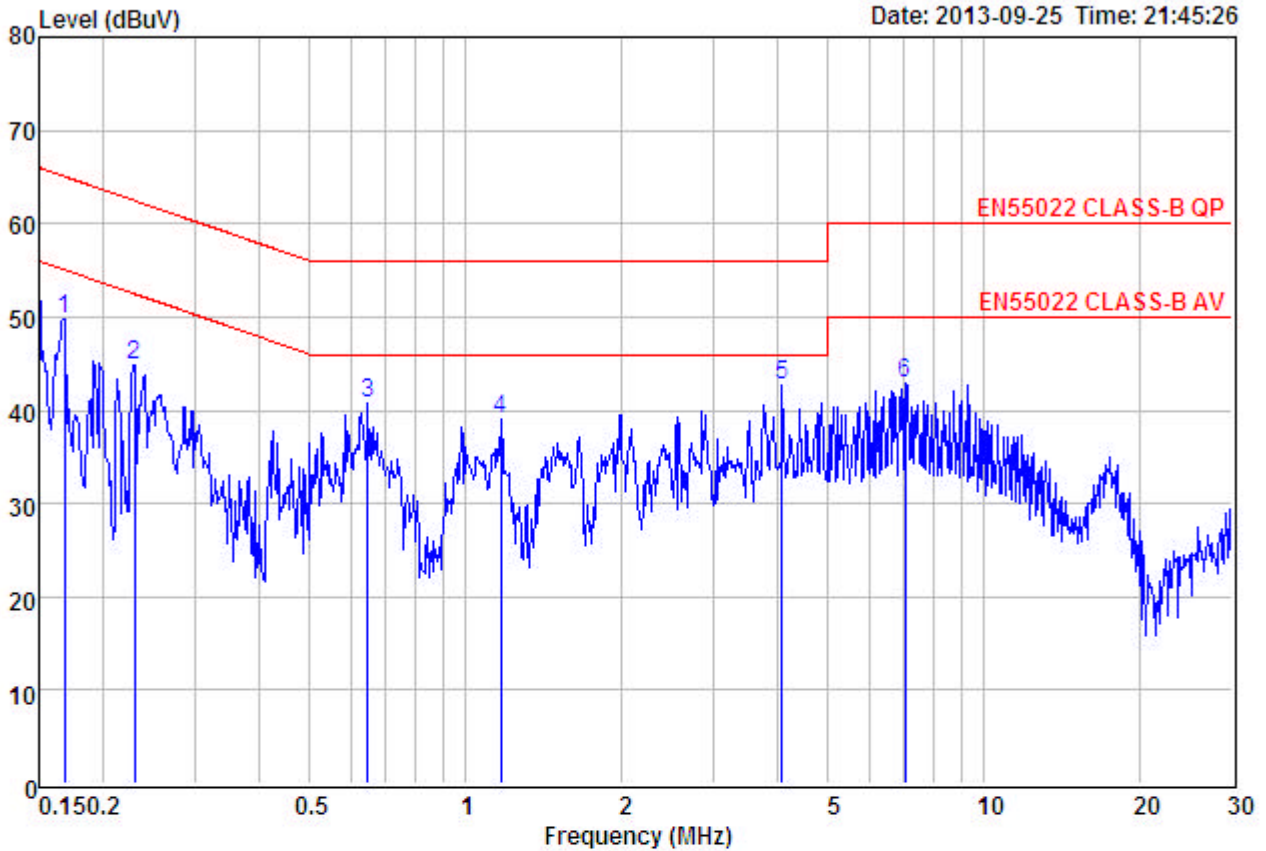

Site : Conduction  
 Condition : EN55022 CLASS-B QP CON-LISN(103) NEUTRAL  
 EUT : Please refer to page 1 of report  
 MODEL : AFS8210M  
 MEMO : WORKING 1024\*768  
 T/H : AC 230V

Remarks: : Factor=Insertion loss+Cable loss

	Freq	Read Level	Level	Factor	Over Limit	Limit Line	Remark
	MHz	dBuV	dBuV	dB	dB	dBuV	
1	0.17	49.63	49.77	0.14	-15.31	65.08	Peak
2	0.23	44.71	44.84	0.13	-17.64	62.48	Peak
3	0.65	40.63	40.79	0.16	-15.21	56.00	Peak
4	1.17	38.84	39.05	0.21	-16.95	56.00	Peak
5	4.07	42.32	42.73	0.41	-13.27	56.00	Peak
6	7.02	42.33	42.86	0.53	-17.14	60.00	Peak



Data: 4

File: D:\CON數據\案件數據\13090307\13090307-CON.EM6 (4)

Date: 2013-09-25 Time: 21:47:07

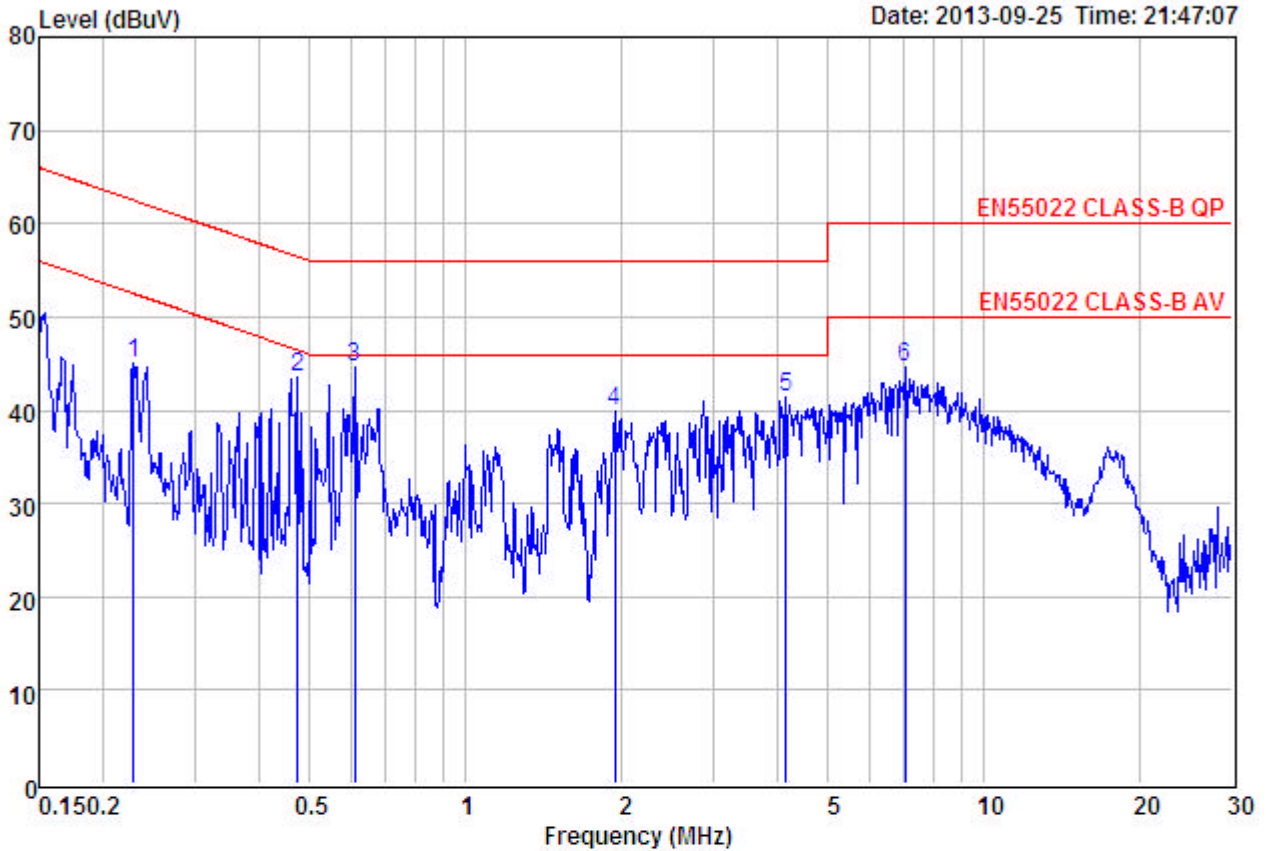

Site : Conduction  
 Condition : EN55022 CLASS-B QP CON-LISN(103) LINE  
 EUT : Please refer to page 1 of report  
 MODEL : AFS8210M  
 MEMO : WORKING 1024\*768  
 T/H : AC 230V

Remarks: : Factor=Insertion loss+Cable loss

	Freq	Read Level	Level	Factor	Over Limit	Limit Line	Remark
	MHz	dBuV	dBuV	dB	dB	dBuV	
1	0.23	44.97	45.11	0.14	-17.41	62.52	Peak
2	0.47	43.37	43.53	0.16	-12.92	56.45	Peak
3	0.61	44.33	44.51	0.18	-11.49	56.00	Peak
4	1.94	39.68	39.98	0.30	-16.02	56.00	Peak
5	4.14	41.06	41.49	0.43	-14.51	56.00	Peak
6	7.02	44.16	44.72	0.56	-15.28	60.00	Peak



Data: 1

File: C:\Users\user\Desktop\今日data\13090307-OPEN6 (4)

Date: 2013-09-09 Time: 10:25:30

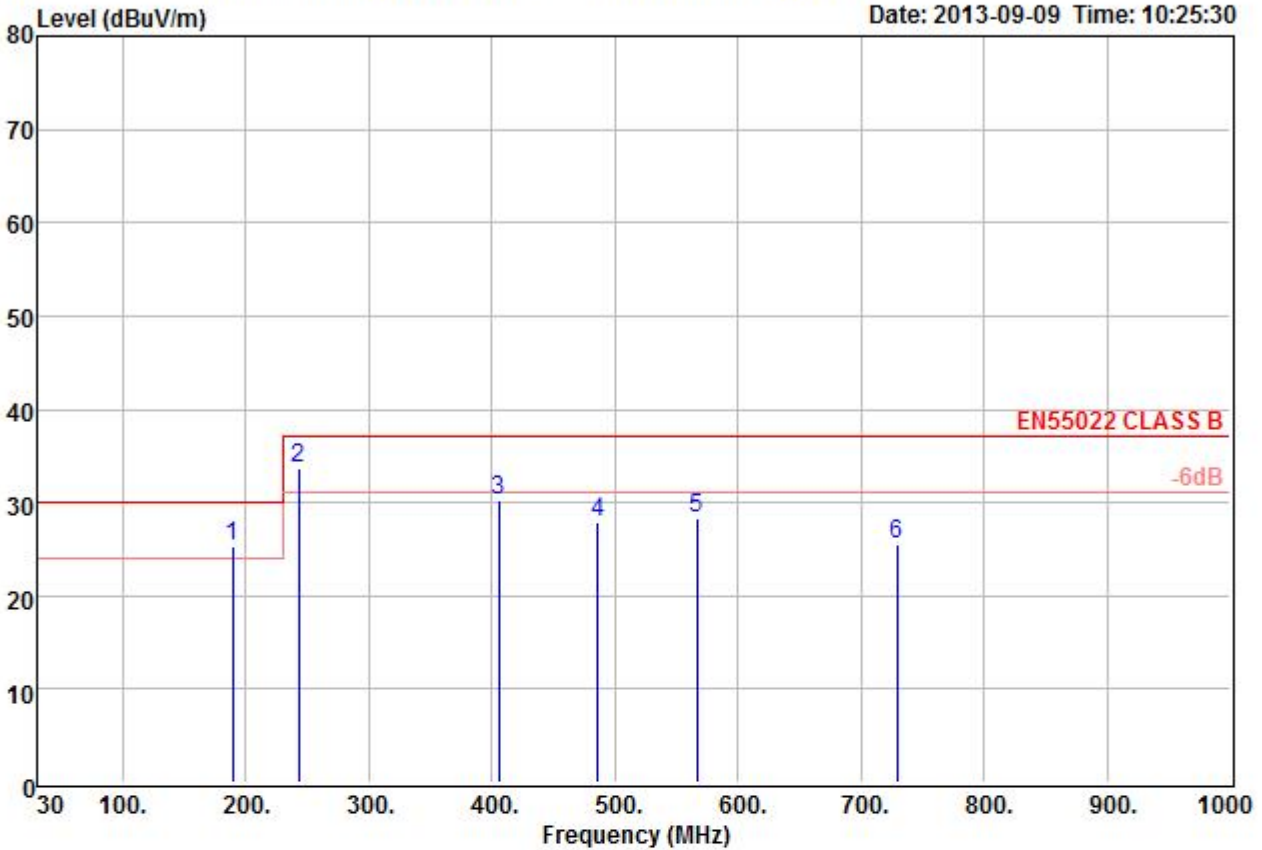

Site : OPEN SITE

Condition: EN55022 CLASS B 10m VULB9160(30-1G)-102 HORIZONTAL

EUT : Please refer to page 1 of report

MODEL : VC01

MEMO : WORKING 1280\*1024

Remarks: : 1.Result=Read Value+Factor

: 2.Factor=Antenna factor+Cable loss-Ampli

		Read			Over	Limit	
	Freq	Level	Level	Factor	Limit	Line	Remark
	MHz	dBuV	dBuV/m	dB/m	dB	dBuV/m	
1 !	189.08	46.55	25.21	-21.34	-4.79	30.00	QP
2 !	242.43	54.43	33.59	-20.84	-3.41	37.00	QP
3	405.39	47.73	30.30	-17.43	-6.70	37.00	QP
4	485.90	42.98	27.94	-15.04	-9.06	37.00	QP
5	566.41	42.90	28.26	-14.64	-8.74	37.00	QP
6	729.37	35.85	25.52	-10.33	-11.48	37.00	QP



Data: 2

File: C:\Users\user\Desktop\今日data\13090307-OPEN6 (4)

Date: 2013-09-09 Time: 11:00:06

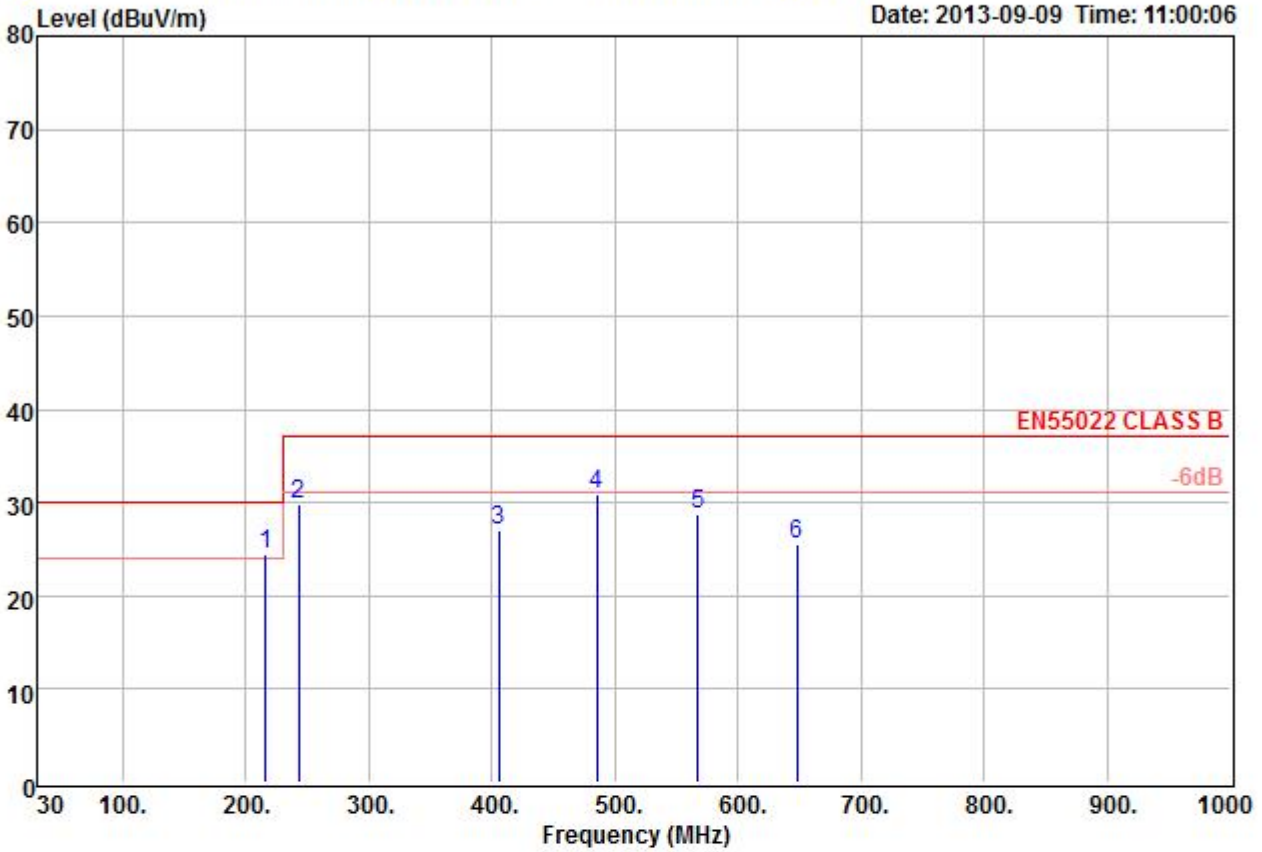

Site : OPEN SITE

Condition: EN55022 CLASS B 10m VULB9160(30-1G)-102 VERTICAL

EUT : Please refer to page 1 of report

MODEL : VC01

MEMO : WORKING 1280\*1024

Remarks: : 1.Result=Read Value+Factor

: 2.Factor=Antenna factor+Cable loss-Ampli

		Read		Over	Limit		
	Freq	Level	Level	Factor	Limit	Line	Remark
	MHz	dBuV	dBuV/m	dB/m	dB	dBuV/m	
1 !	216.24	46.82	24.52	-22.30	-5.48	30.00	QP
2	242.43	50.63	29.79	-20.84	-7.21	37.00	QP
3	405.39	44.38	26.95	-17.43	-10.05	37.00	QP
4	484.93	46.01	30.94	-15.07	-6.06	37.00	QP
5	567.38	43.37	28.75	-14.62	-8.25	37.00	QP
6	647.89	38.66	25.62	-13.04	-11.38	37.00	QP



Data: 3

File: C:\Users\user\Desktop\今日data\13090307-OPEN6 (4)

Date: 2013-09-09 Time: 11:26:02

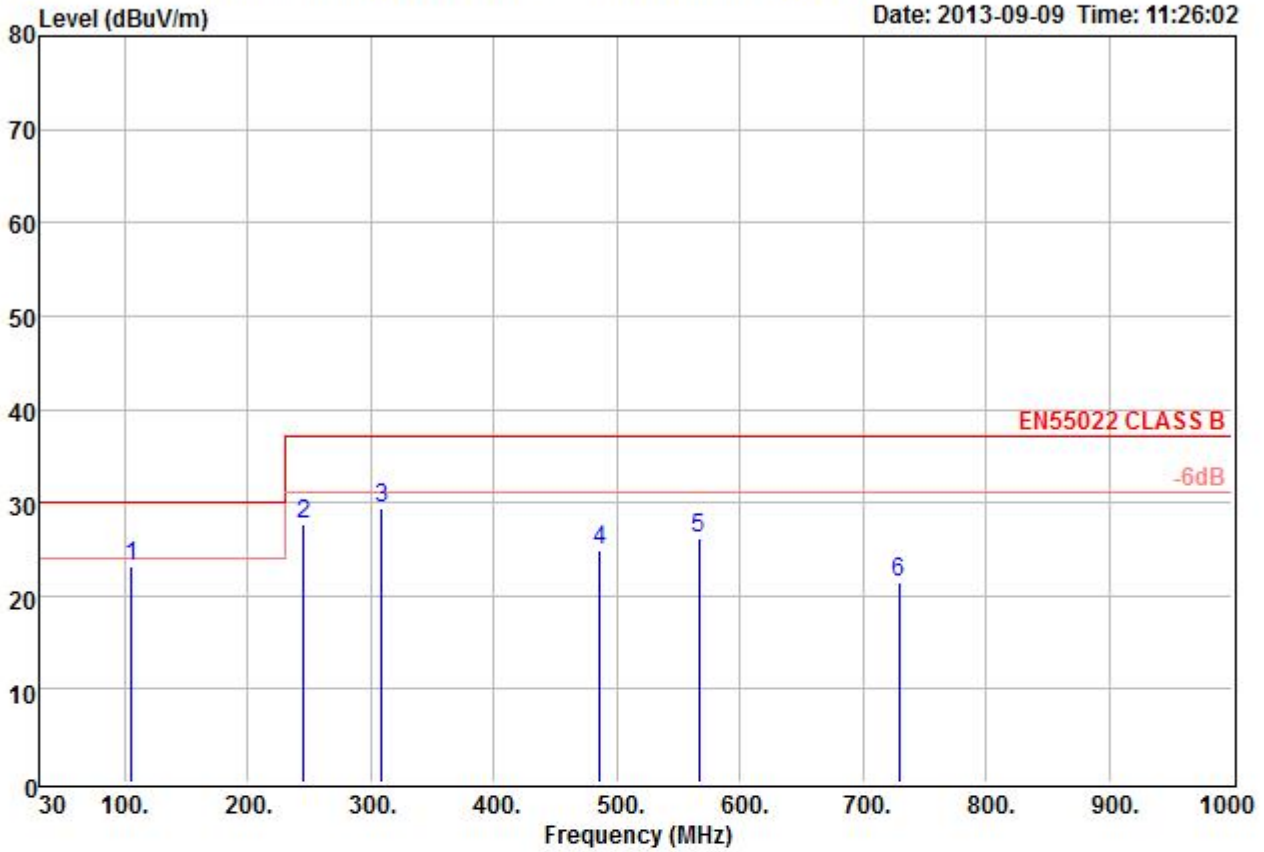

Site : OPEN SITE  
 Condition: EN55022 CLASS B 10m VULB9160(30-1G)-102 HORIZONTAL  
 EUT : Please refer to page 1 of report  
 MODEL : VC01  
 MEMO : WORKING 1024\*768  
 Remarks: : 1.Result=Read Value+Factor  
 : 2.Factor=Antenna factor+Cable loss-Ampli

	Read	Over	Limit				
Freq	Level	Level	Factor	Limit	Line	Remark	
MHz	dBuV	dBuV/m	dB/m	dB	dBuV/m		
1	105.08	44.30	23.21	-21.09	-6.79	30.00	QP
2	245.03	48.38	27.59	-20.79	-9.41	37.00	QP
3	309.10	48.44	29.30	-19.14	-7.70	37.00	QP
4	485.90	39.98	24.94	-15.04	-12.06	37.00	QP
5	566.41	40.90	26.26	-14.64	-10.74	37.00	QP
6	729.37	31.85	21.52	-10.33	-15.48	37.00	QP



Data: 4

File: C:\Users\user\Desktop\今日data\13090307-OPEN6 (4)

Date: 2013-09-09 Time: 11:42:55

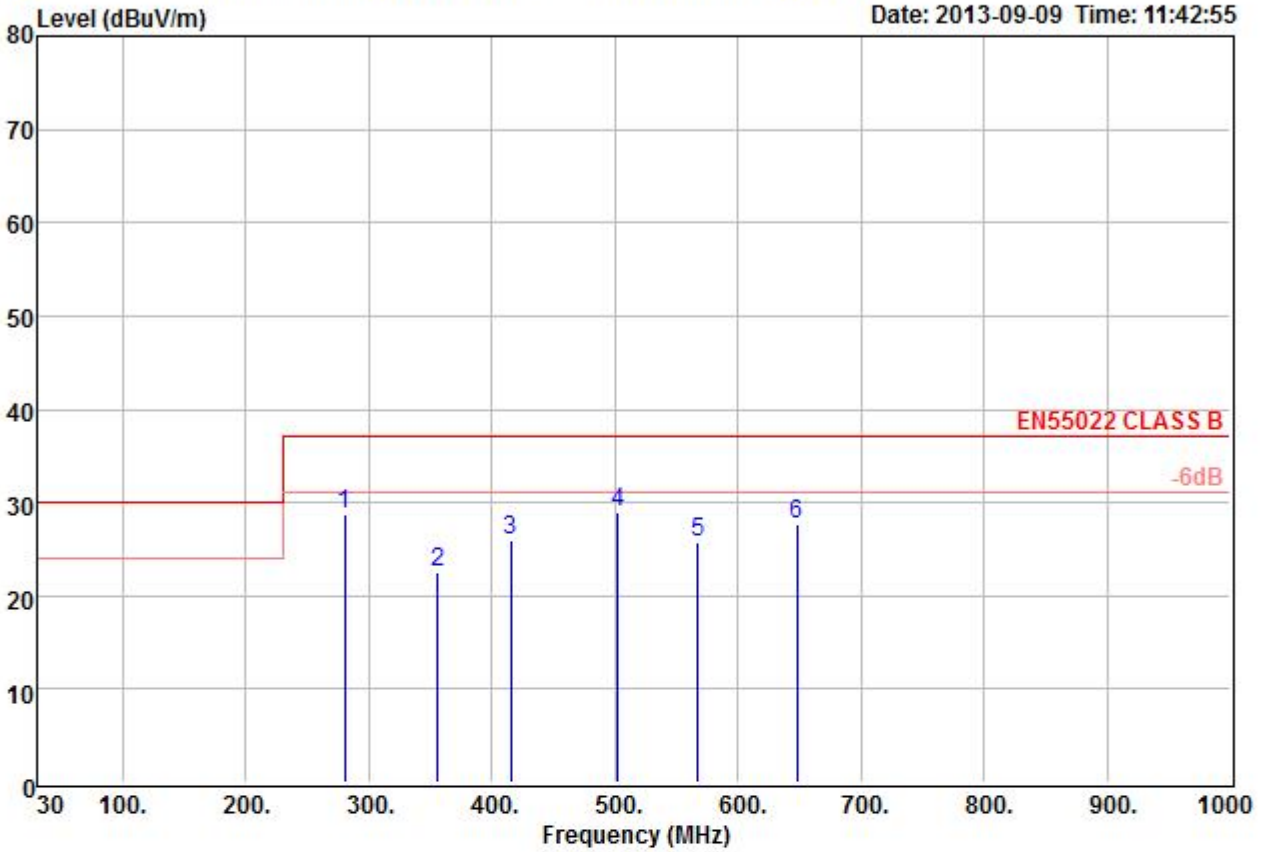

Site : OPEN SITE  
 Condition: EN55022 CLASS B 10m VULB9160(30-1G)-102 VERTICAL  
 EUT : Please refer to page 1 of report  
 MODEL : VC01  
 MEMO : WORKING 1024\*768  
 Remarks: : 1.Result=Read Value+Factor  
 : 2.Factor=Antenna factor+Cable loss-Ampli

	Read	Over	Limit			
Freq	Level	Level	Factor	Limit	Line	Remark
MHz	dBuV	dBuV/m	dB/m	dB	dBuV/m	
1	280.56	48.47	28.79	-19.68	-8.21	37.00 QP
2	355.65	41.05	22.52	-18.53	-14.48	37.00 QP
3	415.39	43.05	25.95	-17.10	-11.05	37.00 QP
4	502.63	43.65	28.94	-14.71	-8.06	37.00 QP
5	567.38	40.37	25.75	-14.62	-11.25	37.00 QP
6	647.89	40.66	27.62	-13.04	-9.38	37.00 QP

File :

Operator  
Unit  
Serial Number  
Remarks

Urms = 60.67V Freq = 19.045 Range: 1 A  
 Irms = 0.083A Ip<sub>k</sub> = 0.477A cf = 5.775  
 P = 2.700W S = 5.006VA pf = 0.539  
 THDi = 90.6 % THDu = 39.8 % Class A

Test completed, Result: PASSED

Order	Freq. [Hz]	Iavg [A]	Irms [A]	Imax [A]	Limit	Status
1	50	0.0367	0.0367	0.0369		
2	100	0.0000	0.0009	0.0009	1.0800	
3	150	0.0292	0.0291	0.0292	2.3000	
4	200	0.0000	0.0009	0.0009	0.4300	
5	250	0.0277	0.0276	0.0278	1.1400	
6	300	0.0000	0.0008	0.0009	0.3000	
7	350	0.0263	0.0262	0.0264	0.7700	
8	400	0.0000	0.0008	0.0009	0.2300	
9	450	0.0247	0.0247	0.0248	0.4000	
10	500	0.0000	0.0008	0.0008	0.1840	
11	550	0.0230	0.0230	0.0231	0.3300	
12	600	0.0000	0.0007	0.0008	0.1533	
13	650	0.0213	0.0213	0.0214	0.2100	
14	700	0.0000	0.0007	0.0007	0.1314	
15	750	0.0196	0.0197	0.0197	0.1500	
16	800	0.0000	0.0007	0.0007	0.1150	
17	850	0.0181	0.0181	0.0181	0.1324	
18	900	0.0000	0.0006	0.0007	0.1022	
19	950	0.0166	0.0167	0.0167	0.1184	
20	1000	0.0000	0.0006	0.0007	0.0920	
21	1050	0.0154	0.0154	0.0154	0.1071	
22	1100	0.0000	0.0005	0.0006	0.0836	
23	1150	0.0142	0.0142	0.0143	0.0978	
24	1200	0.0000	0.0005	0.0006	0.0767	

25	1250	0.0132	0.0132	0.0132	0.0900
26	1300	0.0000	0.0005	0.0005	0.0708
27	1350	0.0122	0.0123	0.0123	0.0833
28	1400	0.0000	0.0005	0.0005	0.0657
29	1450	0.0113	0.0114	0.0114	0.0776
30	1500	0.0000	0.0005	0.0005	0.0613
31	1550	0.0105	0.0105	0.0105	0.0726
32	1600	0.0000	0.0004	0.0005	0.0575
33	1650	0.0097	0.0097	0.0097	0.0682
34	1700	0.0000	0.0004	0.0004	0.0541
35	1750	0.0089	0.0089	0.0089	0.0643
36	1800	0.0000	0.0004	0.0004	0.0511
37	1850	0.0081	0.0081	0.0082	0.0608
38	1900	0.0000	0.0004	0.0004	0.0484
39	1950	0.0074	0.0074	0.0074	0.0577
40	2000	0.0000	0.0004	0.0004	0.0460

Important:

- 100% of time voltage "out of Spec"

Voltage on EUT

Current into EUT

Urms = 60.67 V P = 2.700 W

Irms = 0.083 A pf = 0.539

THC = 0.079 A

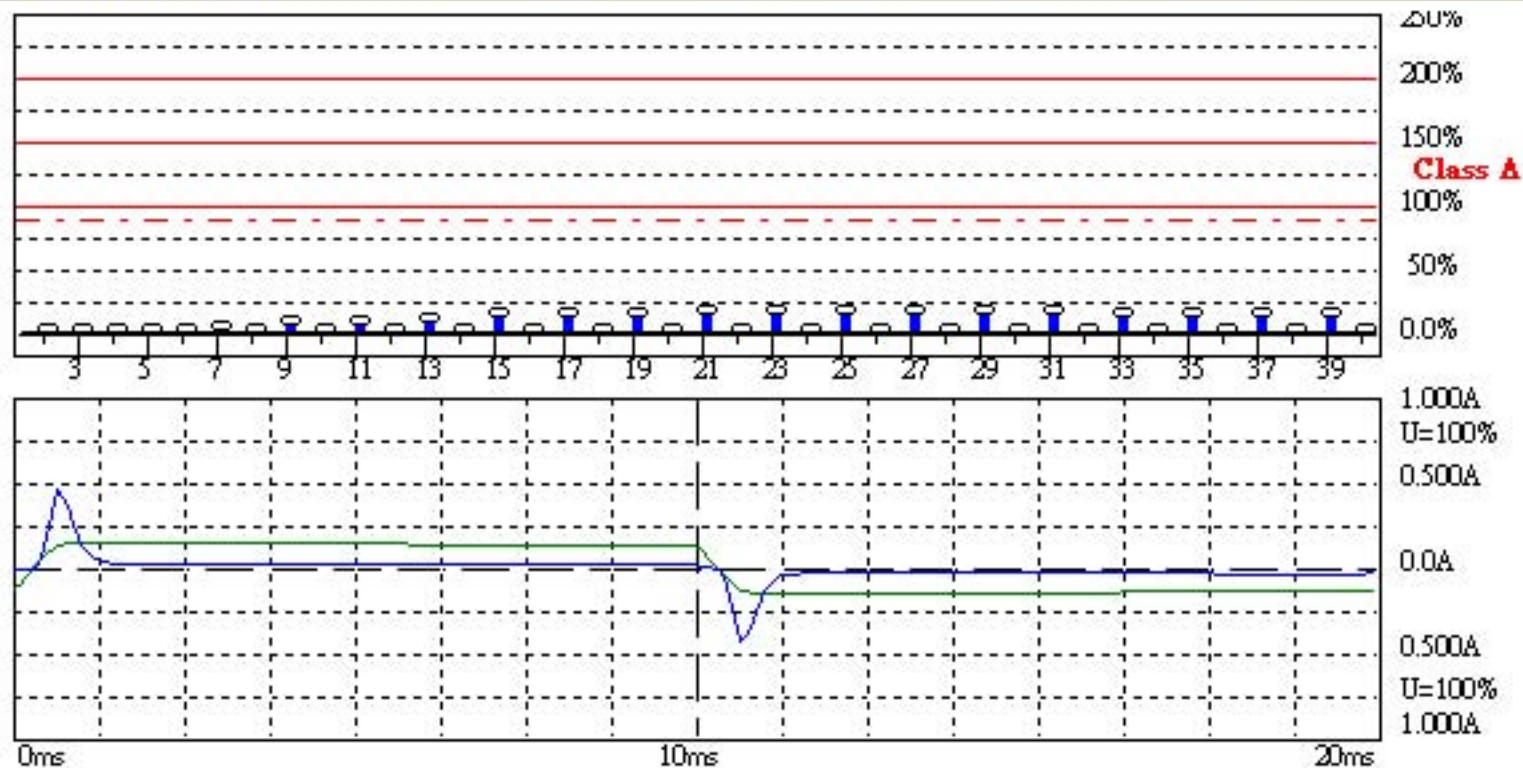

File :

Operator  
Unit  
Serial Number  
Remarks

Urms = 60.28V Freq = 20.217 Range: 2 A  
Irms = 0.087A Ipk = 0.499A cf = 5.742  
P = 2.749W S = 5.239VA pf = 0.525

LIN (Line Impedance Network) : L: 0.24ohm +j0.15ohm N: 0.16ohm +j0.10ohm

Limits : Plt : 0.65 Pst : 1.00  
dmax : 4.00 % dc : 3.00 %  
dtLim: 3.00 % dt>Lim: 200ms

Test completed, Result: PASSED

	dmax [%]
1	0.000
2	0.000
3	0.000
4	0.000
5	0.000
6	0.000
7	0.000
8	0.000
9	0.000
10	0.000

**Cumulative Probability  
Function**

Urms = 60.28 V

P = 2.749 W

d(t) : steady



Irms = 0.087 A

pf = 0.525

Time: 1.0 min

Flickermeter 1000-4-15 for 230V/50Hz

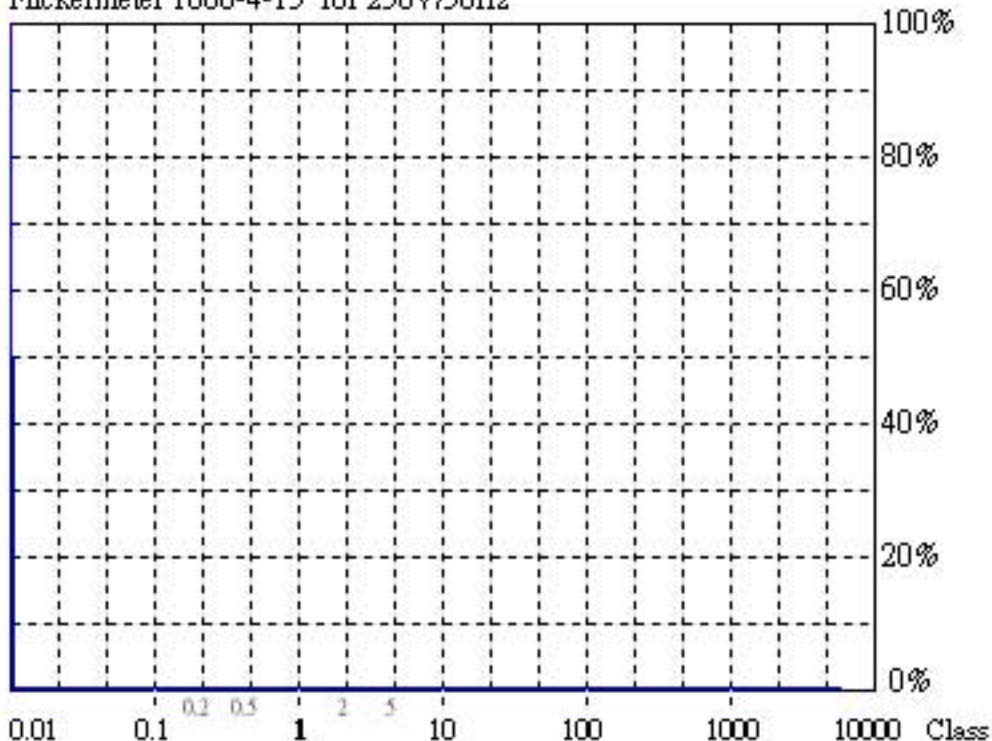

**Actual Flicker (Fli): 0.00**

**Short-term Flicker (Pst): 0.07**

Limit (Pst): 1.00

**Long-term Flicker (Plt): 0.07**

Limit (Plt): 0.65

**Maximum Relative  
Volt. Change (dmax): 0.00%**

Limit (dmax): 4.00%

**Relative Steady-state  
Voltage Change (dc): 0.01%**

Limit (dc): 3.00%

**Maximum Interval  
exceeding 3.00% (dt): 0.00ms**

Limit (dt>Lim): 200ms

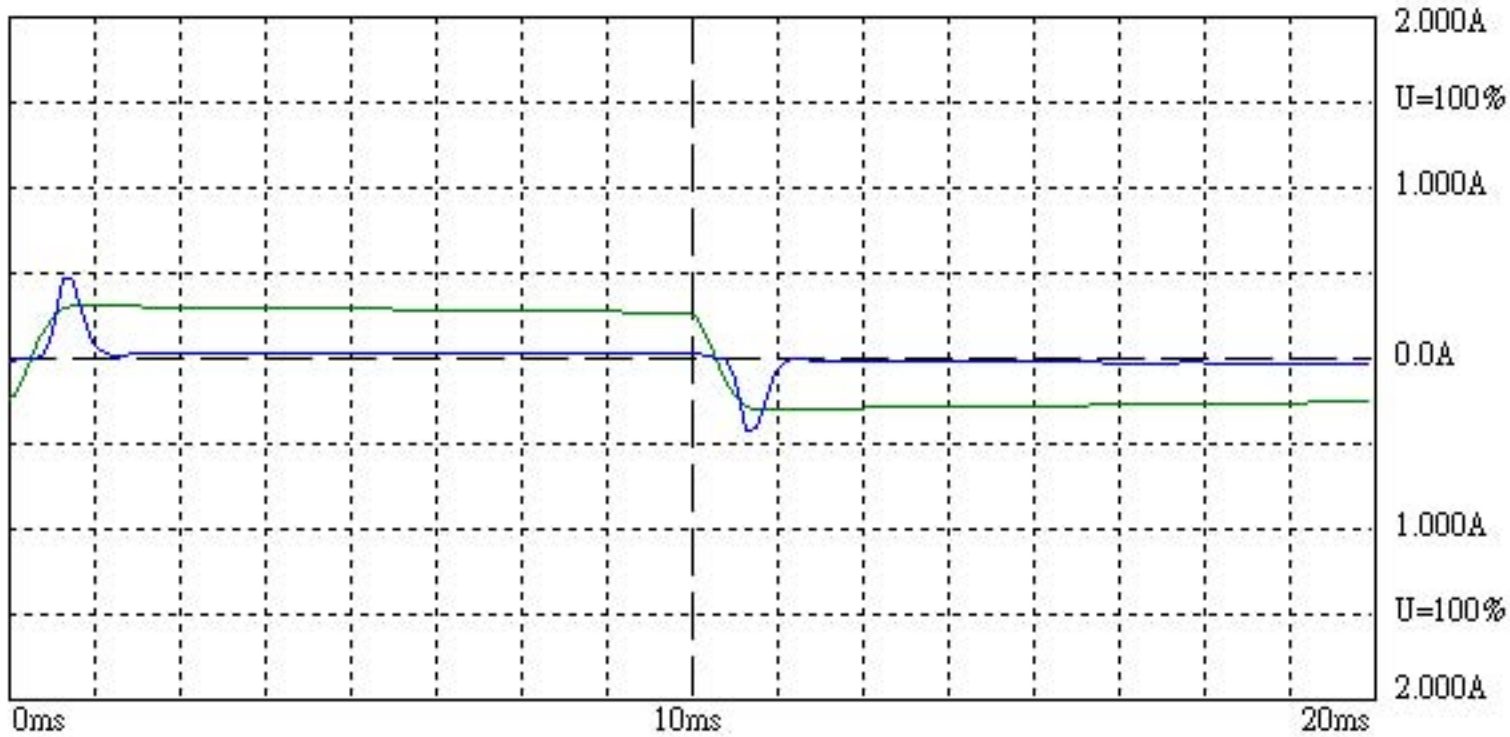
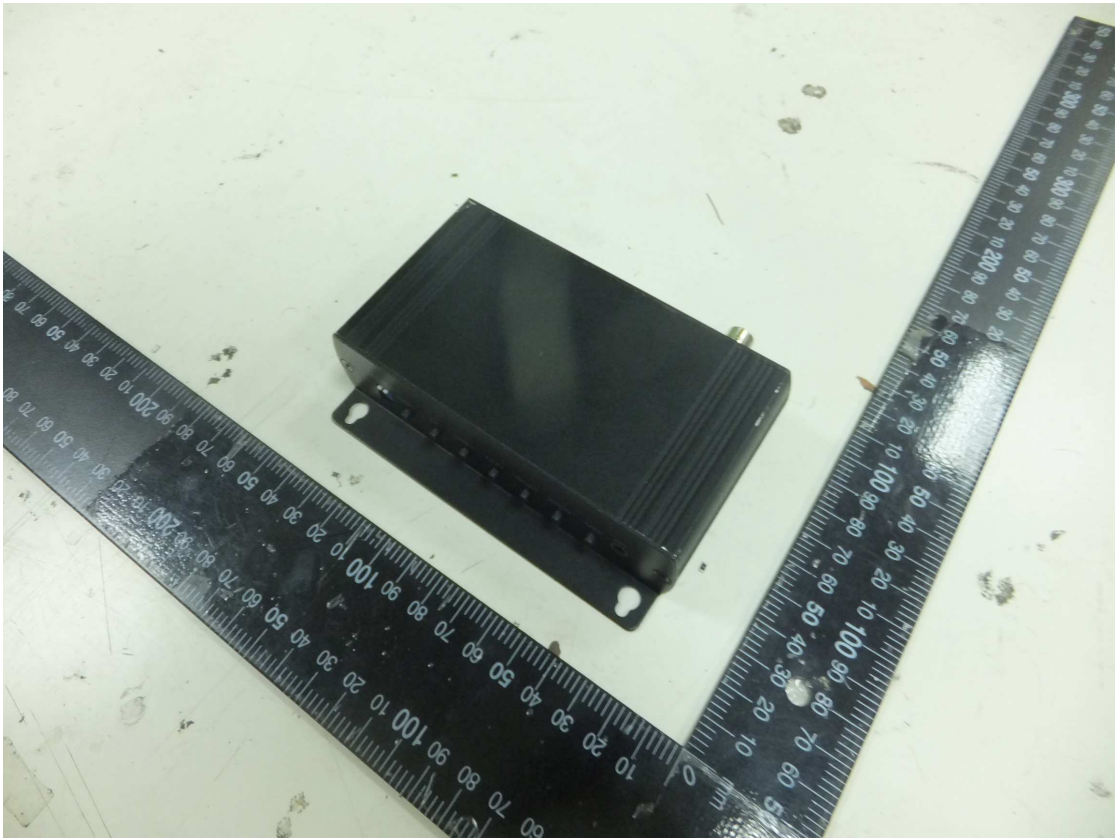



**PHOTO OF EUT**

**PHOTOS OF EUT**

01 Front view of EUT



02 Rear view of EUT

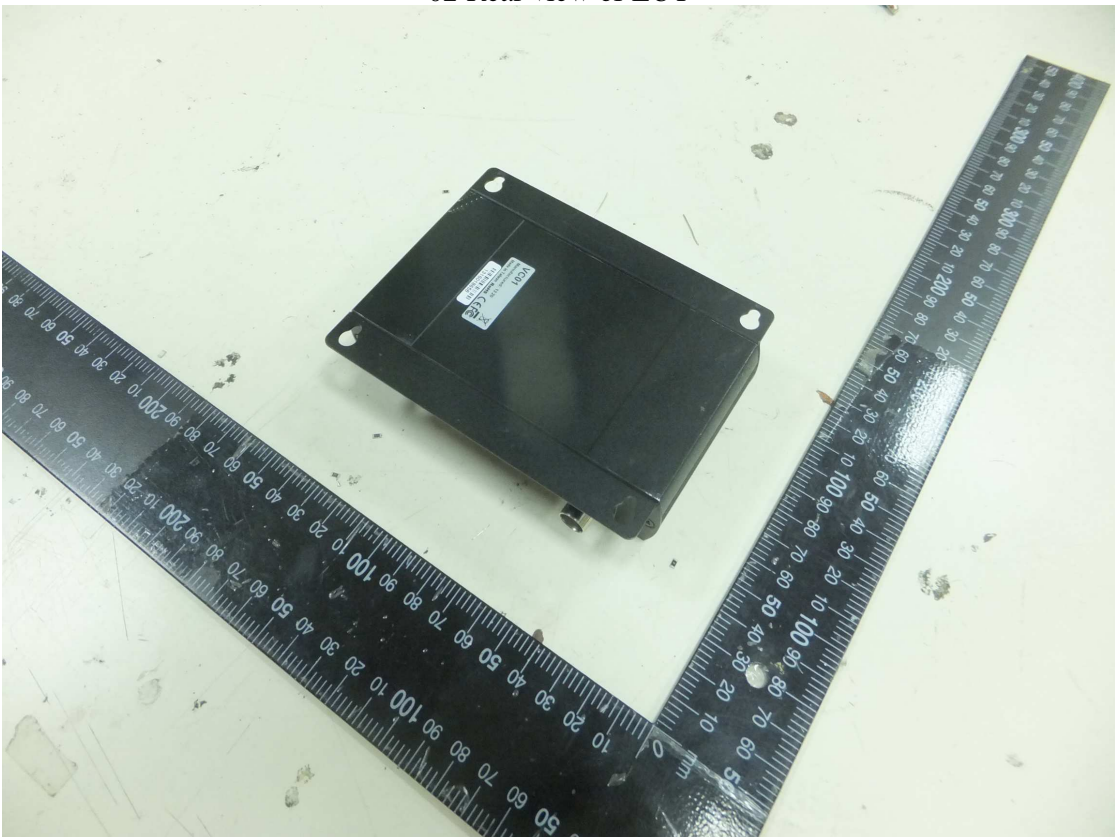

03 IO Port of EUT(Video out & VGA IN &VGA OUT & DC IN )



04 Inside Port of EUT



05 PCB-F

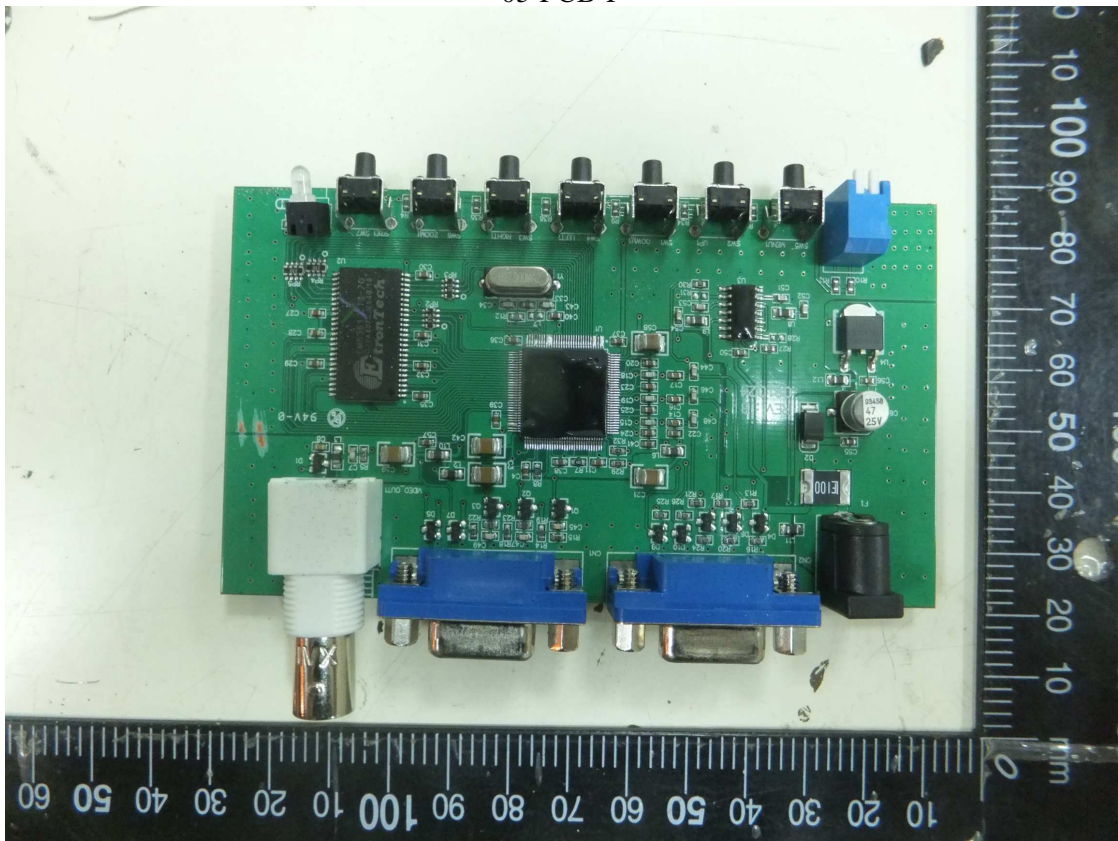

06 PCB-R

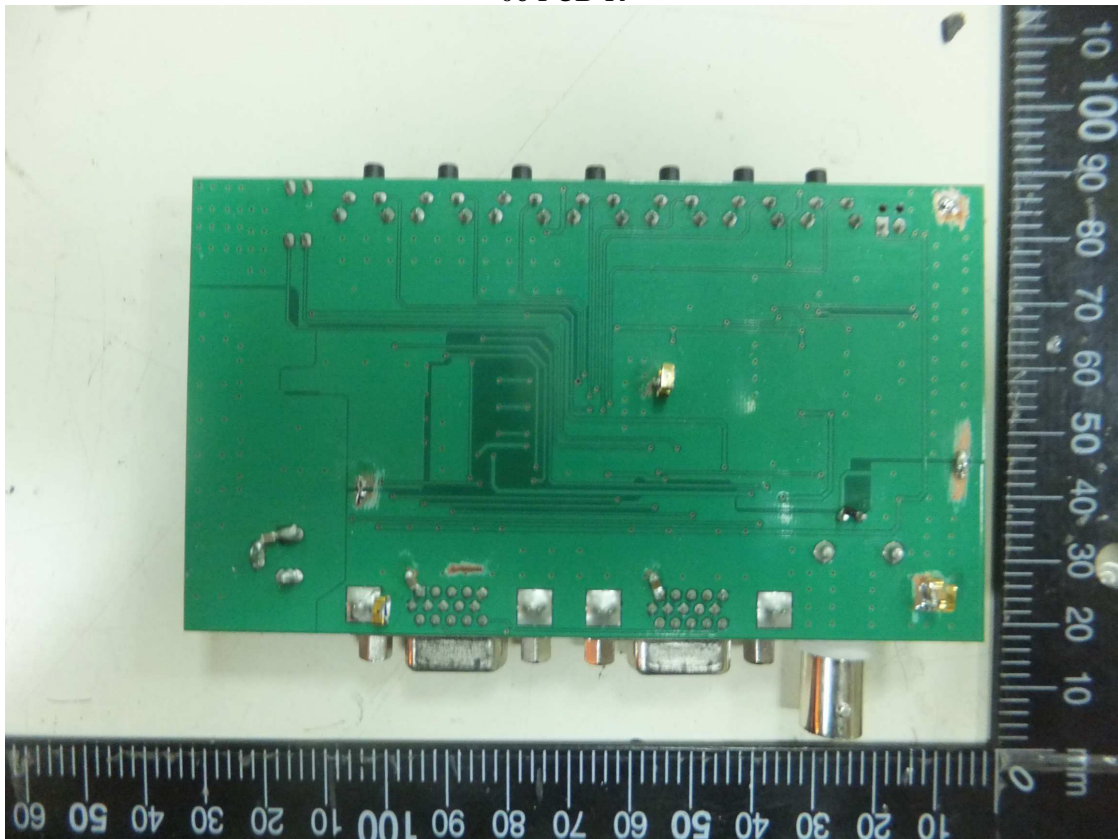

07 Adaptor



08 Cable

