



HomeTek Technology Inc.

ADDRESS: No. 67-9, Shir Men Road, Tu Cheng City,
Taipei Hsien, Taiwan

PHONE : 886-2-22608375 FAX : 886-2-22748013

E - mail : hometek@ms15.hinet.net

FCC TEST REPORT FOR

APPLICANT : Smart Home Engineering Corp.
ADDRESS : 10F, No. 493, Chung-Cheng Rd.,
Hsin Tien City, Taipei 231, Taiwan, R. O. C.
EUT : Multimedia AV Distribution Amplifier
MODEL NO. : CD0XXX

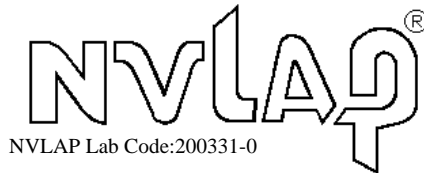

Accredited by the National Voluntary Laboratory Accreditation Program
for the specific scope of accreditation under Lab Code 200331-0

MEASUREMENT PROCEDURE USED

FCC RULES AND CISPR 22-2005 AND FCC / ANSI C63.4-2003

PREPARED BY :

HomeTek Technology Inc.

No. 67-9, Shir Men Road, Tu Cheng City,

Taipei Hsien. Taiwan

Report # : FD6K012



TABLE OF CONTENTS..... 2

CERTIFICATION..... 3

GENERAL INFORMATION..... 4

MODIFICATION LIST..... 6

CONDUCTED POWER LINE TEST 7

 1 TEST INSTRUMENTS & FACILITIES 7

 2 TEST PROCEDURE 7

 3 TEST SETUP..... 8

 4 CONFIGURATION OF THE EUT 10

 5 EUT OPERATING CONDITION 12

 6 LIMIT OF CONDUCTED POWER LINE EMISSION CLASS B 12

 7 RESULT OF CONDUCTED POWER LINE TEST 12

 8 CONDUCTED POWER LINE TEST DATA (PAGE 1) 13

 9 CONDUCTED POWER LINE TEST DATA (PAGE 2) 14

 10 CONDUCTED POWER LINE TEST DATA (PAGE 3) 15

 11 CONDUCTED POWER LINE TEST DATA (PAGE 4) 16

RADIATED EMISSION TEST..... 17

 1 TEST INSTRUMENTS & FACILITIES 17

 2 TEST PROCEDURE 18

 3 TEST SETUP..... 18

 4 CONFIGURATION OF THE EUT 20

 5 EUT OPERATING CONDITION 20

 6 LIMIT OF RADIATED EMISSION CLASS B 20

 7 RESULT OF RADIATED EMISSION TEST 21

 8 RADIATED EMISSION TEST DATA (PAGE 1) 22

 9 RADIATED EMISSION TEST DATA (PAGE 2) 23

SAMPLE OF FCC DOC LABEL 1 24

SAMPLE OF FCC DOC LABEL 2 24

APPENDIX A

PHOTOS OF TEST CONFIGURATION

APPENDIX B

PHOTOS OF EUT

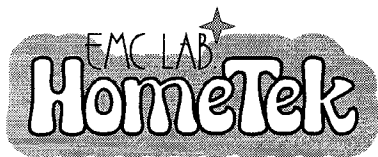

HomeTek Technology Inc.

ADDRESS: No. 67-9, Shir Men Road, Tu Cheng City, Taipei Hsien, Taiwan
PHONE : 886-2-22608375 FAX : 886-2-22748013
E - mail : hometek@ms15.hinet.net



CERTIFICATION
for
FCC Part 15, Subpart B Class B

APPLICANT : Smart Home Engineering Corp.
ADDRESS : 10F, No. 493, Chung-Cheng Rd., Hsin Tien City, Taipei 231, Taiwan, R. O. C.
Receipt Date : 11/08/2007 Final Test Date: 12/07/2007
EUT : Multimedia AV Distribution Amplifier
MODEL NO. : CD0XXX

MEASUREMENT PROCEDURE USED :

PART 15 SUBPART B FCC RULES AND CISPR 22-1997
AND FCC / ANSI C63.4-2003

TEST PROCEDURE AND DATA ARE TRACEABLE TO NIST/USA,
TL or NML/TAIWAN.

- THE MAXIMUM EMISSION LEVELS WERE COMPARED TO THE CISPR 22 CLASS B LIMITS BOTH RADIATED AND CONDUCTED EMISSION.
THE ABOVE DEVICE WAS TESTED BY HOMETEK TECHNOLOGY INC. TO SHOWS THE MAXIMUM EMISSION LEVEL FROM THE DEVICE.
THIS TEST RESULTS OF THIS REPORT APPLIES TO ABOVE TESTED SAMPLE ONLY.
THIS TEST REPORT SHALL NOT BE REPRODUCE IN PART WITHOUT WRITTEN APPROVAL OF HOMETEK TECHNOLOGY INC.
THE REPORT MUST NOT BE USED BY THE CLIENT TO CLAIM PRODUCT ENDORSEMENT BY NVLAP, NIST OR ANY AGENCY OF THE U. S. GOVERNMENT.
THE TEST RESULTS ARE TRACEABLE TO THE NATIONAL OR INTERNATIONAL STANDARD.

APPROVED BY:

Handwritten signature of Grant Huang
GRANT HUANG / Manager

GENERAL INFORMATION

1 APPLICANT : Smart Home Engineering Corp.

2 ADDRESS : 10F, No. 493, Chung-Cheng Rd.,
Hsin Tien City, Taipei 231, Taiwan, R. O. C.

3 MANUFACTURER : Smart Home Engineering Corp.

4 ADDRESS : 10F, No. 493, Chung-Cheng Rd.,
Hsin Tien City, Taipei 231, Taiwan, R. O. C.

5 DESCRIPTION OF EUT :

EUT : Multimedia AV Distribution Amplifier

FCC ID : N/A

Model Number : CD0XXX

Serial # : N/A

5.1 The difference between series of models CD0XXX are as shown below:

- (1) The first “X” represents different system input.
- (2) The second “X” represent different accessory.
- (3) The third “X” represent different color.

The PCB layout is similar. The worst case of EMI test data were shown in this test report.

6 FEATURES OF EUT :

1 Input 4 Output Composite Video Distribution Amplifier with Digital/Optical Audio.

7 TEST MODE :

The EUT were investigated with four resolution modes shown as below :

- (1) AV input and AV-1 output Mode
- (2) AV input and AV-2 output Mode
- (3) AV input and AV-3 output Mode
- (4) AV input and AV-4 output Mode

The test mode of (3) AV input and AV-3 output Mode is worst case,
and the final test data were shown in this test report.



MODIFICATION LIST

THE FOLLOWING ACCESSORIES WERE ADDED TO THE EUT DURING TESTING :

NO MODIFICATION BY HOMETEK TECHNOLOGY INC.

CONDUCTED POWER LINE TEST

1 TEST INSTRUMENTS & FACILITIES

The following test Instruments was used during the conducted test :

Item	Instruments/ Facilities	Specification	Manufacturer	Model #	Date Of Cal.
1	EMI Receiver	9KHz ~ 30MHz	ROHDE & SCHWARZ	ESHS10 840449/001	DEC/2006
2	LISN (for EUT)	50Ω/50uH/16A 9KHz ~ 30MHz	AFJ	LT32 32039930056	DEC/2006
3	LISN (for Support Unit)	50Ω/50uH/15A 150KHz ~ 30MHz	SANKI	LISN1-15V 080404E	DEC/2006
4	Terminator	50Ω	N/A	N/A	DEC/2006
5	Attenuation	50Ω/10dB	Mini-Circuit	NAT-10 AT-002	DEC/2006
6	Cable	5.4m	SUHNER	RG-223 CON2-001	DEC/2006
7	ESXS-K1 (software)	Version 2.03b 9KHz ~ 30MHz	ROHDE & SCHWARZ	1082.9678.02 840.913/246	N/A

Note : Items 1 ~ 6 were calibrated within period of 1 year.

2 TEST PROCEDURE

- 2.1 The EUT was tested according to **ANSI C63.4 – 2003 Section 5.2, 7.1, 7.2 & CISPR 22 - 1997 & C18-01-12 (HomeTek test procedure)**.
- 2.2 The EUT was placed 0.4 meter from the conducting wall of shielding room and kept at least 0.8 meter from any other grounded conducting surface.
- 2.3 The frequency range form 0.15 MHz to 30 MHz was investigated.
- 2.4 The LISN used was 50 Ohm / 50 uHenry as specified by Section 4.1.2 of **ANSI C63.4 - 2003**.
- 2.5 All the support peripherals are connect to the other LISN.
- 2.6 Cables and peripherals were moved to find the maximum emission levels for each frequency.

3 TEST SETUP

3.1 Typical : Setup Of Conducted Test

ELECTRICAL AND ELECTRONIC EQUIPMENT IN THE RANGE OF 9kHz TO 40 GHz

ANSI
C63.4-2003

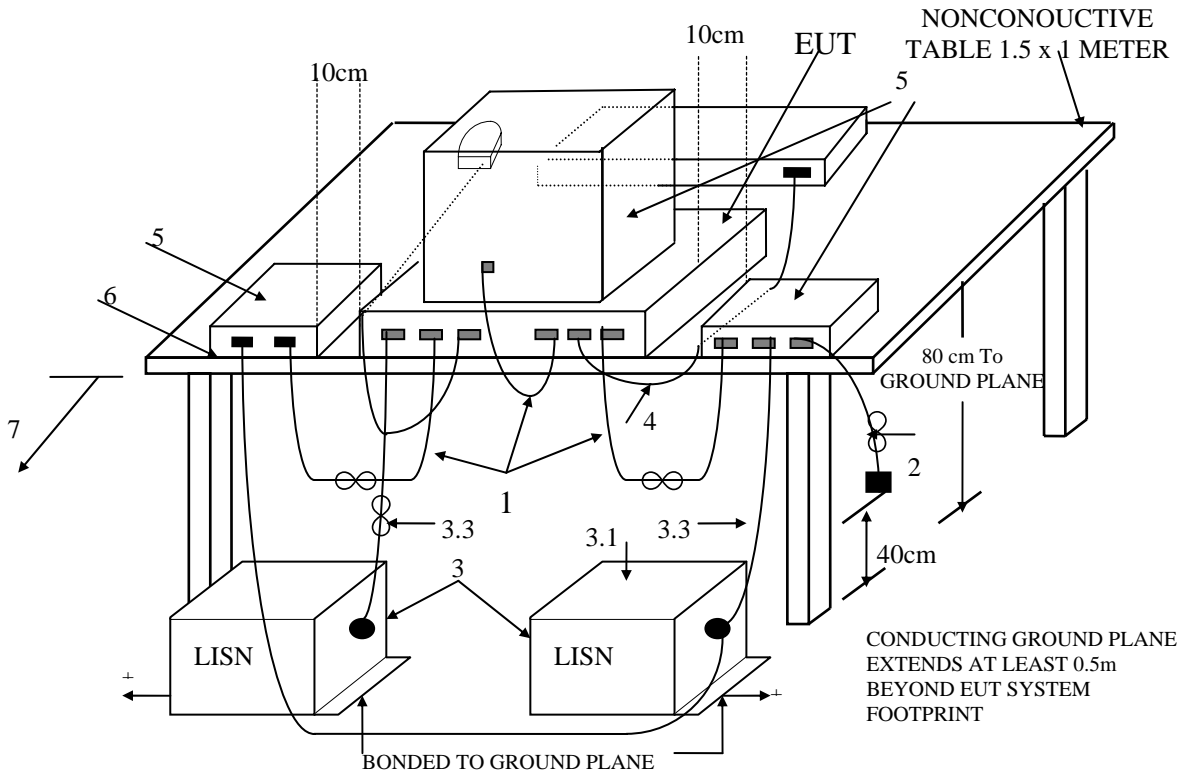

+LISNs may have to be moved to the side to meet 3.3 below.

(Details for setup configuration, please refer to appendix A.)

LEGEND:

1. Interconnecting cables that hang closer than 40 cm to the ground plane shall be folded back and forth forming a bundle 30 to 40 cm long, hanging approximately in the middle between ground plane and table.
2. I/O cables that are connected to a peripheral shall be bundled in center. The end of the cable may be terminated if required using correct terminating impedance. The total length shall not exceed 1m.
3. EUT connected to one LISN. Unused LISN connectors shall be terminated in 50 Ω. LISN can be placed on top of, or immediately beneath, ground plane.
 - 3.1 All other equipment powered from second LISN.
 - 3.2 Multiple outlet strip can be used for multiple power cords of non-EUT equipment.
 - 3.3 LISN at least 80 cm from nearest part of EUT chassis.
4. Cables of hand-operated devices, such as keyboards, mice, etc., have to be placed as close as possible to the host.
5. Non-EUT components being tested.
6. Rear of EUT, including peripherals, shall be all aligned and flush with rear of tabletop.
7. Rear of tabletop shall be 40 cm removed from a vertical conducting plane that is bonded to the floor ground plane (see 5.2).

**Test Configuration
Tabletop Equipment Conducted Emission**

3.2 Block Diagram Of Conducted Test

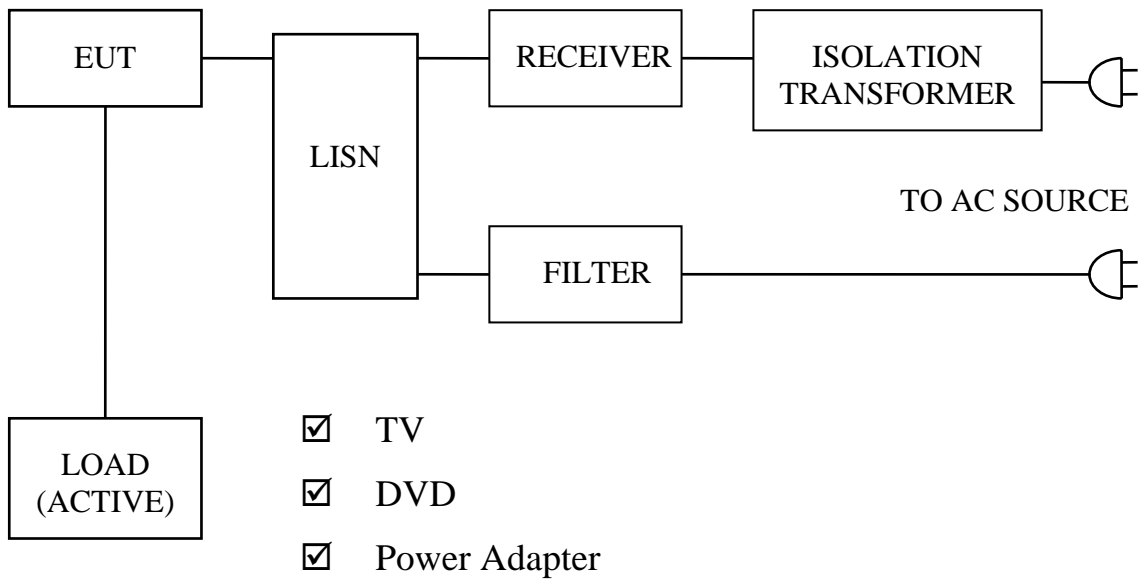

4 CONFIGURATION OF THE EUT

The EUT was configured according to **ANSI C63.4 - 2003 & CISPR 22 - 1997**. All I/O ports were connected to the appropriate peripherals. All peripherals and cables are listed below (including internal device) :

4.1 EUT

EUT Type	: <input type="checkbox"/> Proto Type <input checked="" type="checkbox"/> Engineer Type <input type="checkbox"/> Mass Production
Condition when received	: <input checked="" type="checkbox"/> Good <input type="checkbox"/> Damage : _____
Device	: Multimedia AV Distribution Amplifier
Applicant	: Smart Home Engineering Corp.
Manufacturer	: Smart Home Engineering Corp.
Model Number	: CD0XXX
Serial Number	: N/A
FCC ID	: N/A
Video input Cable	: Un-Shielded, 1.5 m
Coaxial input Cable	: Un-Shielded, 1.5 m
Optical input Cable	: Un-Shielded, 5 m
Video output Cable	: Un-Shielded, 1.5 m
Coaxial output Cable	: Un-Shielded, 1.5 m
Optical output Cable	: Un-Shielded, 5 m
Power Cord (AC)	: N/A
Power Cord (DC)	: Un-Shielded, 1.75 m
Power Supply Type	: Switching Power Adapter

4.2 PERIPHERALS

TV

Manufacturer : SAMSUNG
Model Number : LA26R51B
Serial Number : 3WDY800979Y
FCC ID : FCC DoC
Power Cord : Un-Shielded, 1.5 m

DVD

Manufacturer : PHILIPS
Model Number : DVP5965K/93
Serial Number : KX1A0619825341
FCC ID : FCC DoC
Power Cord : Un-Shielded, 1.5 m

Power Adapter

Manufacturer : ELEC
Model Number : ADP051200R-1
Serial Number : N/A
FCC ID : N/A
Data Cable : N/A
Power Cord (DC) : Un-Shielded, 1.75 m

4.3 REMARK : N/A

5 EUT OPERATING CONDITION

- 5.1 T The frequency of the EUT is none.
- 5.2 Configure the EUT according to the **EN 55022 Class B**.
- 5.3 The test configuration included TV, DVD and Adapter.
- 5.4 Turn on all the power of EUT and peripheral.
- 5.5 DVD sends data signal to TV via EUT's AV port.
- 5.6 During the test, the DVD sends "H" patterns to each I/O port individually. EUT display "H" character.
- 5.7 Adjust the location of EUT and peripheral to gain the maximum EMI noise.
- 5.8 The photos of conducted test configuration, please refer to appendix A.**

6 LIMIT OF CONDUCTED POWER LINE EMISSION CLASS B

Frequency Range	Quasi Peak	Average
0.15 ~ 0.5 MHz	66 - 56 dBuV	56 - 46 dBuV
0.5 ~ 5 MHz	56 dBuV	46 dBuV
5 ~ 30 MHz	60 dBuV	50 dBuV

- 6.1 In the above table, the tighter limit applies at the band edges.

7 RESULT OF CONDUCTED POWER LINE TEST

- 7.1 The frequency range from 0.15 MHz to 30 MHz was investigated. All readings are quasi-peak values and average.
- 7.2 IF bandwidth : 9 kHz, Meas Time : 1 sec.
- 7.3 Temperature : 21.5 °C, Humidity : 47 % RH.
- 7.4 Deviations from the test standards and rules : None
- 7.5 The conducted test result were gained by following procedures :
 Level = Reading Level + Insertion Loss of LISN + Cable Loss
 (All calculation were done by ESHS10 EMI test receiver.)
- 7.6 Result : **PASSED**

8 CONDUCTED POWER LINE TEST DATA (PAGE 1)

HomeTek EMC LAB. TEL :86-769-85303005 , 886-2-22608375

07 Dec 2007 09:53

CONDUCTED EMISSIONS

EUT: CD04D
 Manuf: 6K012
 Op Cond: LINE
 Operator: FELIX
 Test Spec: FOR CISPR22 CLASS B
 Comment: 110V/60Hz
 AV INPUT AND AV-3 OUTPUT MODE
 Result File: 6K012031.dat

Prescan Measurement:	Detectors:	X PK / + AV
	Meas Time:	see scan settings
	Subranges:	8
	Acc Margin:	55 dB

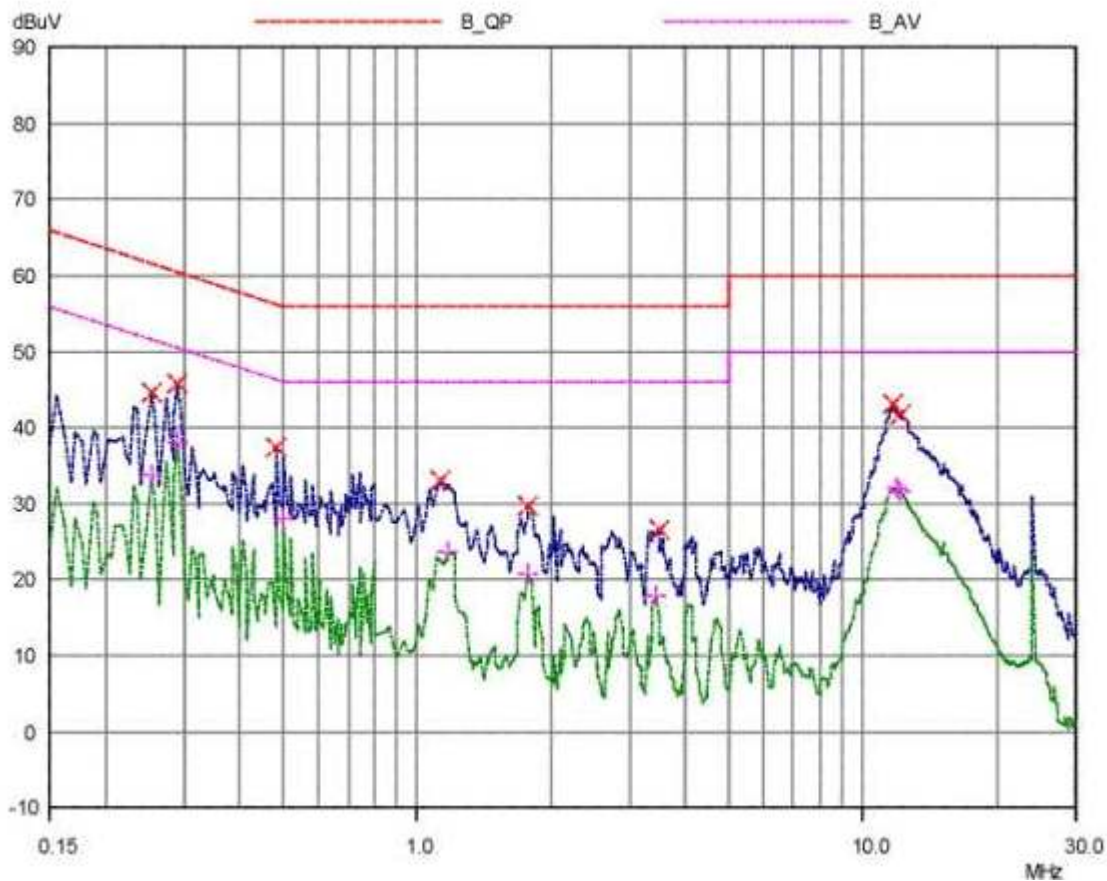



9 CONDUCTED POWER LINE TEST DATA (PAGE 2)

HomeTek EMC LAB. TEL :86-769-85303005 , 886-2-22608375

07 Dec 2007 09:53

CONDUCTED EMISSIONS

EUT: CD04D
 Manuf: 6K012
 Op Cond: LINE
 Operator: FELIX
 Test Spec: FOR CISPR22 CLASS B
 Comment: 110V/60Hz
 AV INPUT AND AV-3 OUTPUT MODE
 Result File: 6K012031.dat

Prescan Measurement: Detectors: X PK / + AV
 Meas Time: see scan settings
 Subranges: 8
 Acc Margin: 55 dB

Peak Search Results

Frequency MHz	PK Level dBuV	PK Limit dBuV	PK Delta dB
0.25	44.56	61.76	17.20
0.29	45.74	60.52	14.78
0.4825	37.54	56.30	18.76
1.12	33.03	56.00	22.97
1.78	29.75	56.00	26.25
3.48	28.50	56.00	29.50
11.64	43.21	60.00	16.79
12.06	41.70	60.00	18.30

Frequency MHz	AV Level dBuV	AV Limit dBuV	AV Delta dB
0.25	33.85	51.76	17.91
0.29	38.22	50.52	12.30
0.502	27.93	46.00	18.07
1.16	23.73	46.00	22.27
1.76	20.73	46.00	25.27
3.44	17.85	46.00	28.15
11.84	32.12	50.00	17.88
12.12	31.73	50.00	18.27

* limit exceeded

10 CONDUCTED POWER LINE TEST DATA (PAGE 3)

HomeTek EMC LAB. TEL :86-769-5303005 , 886-2-22608375

07 Dec 2007 10:02

CONDUCTED EMISSIONS

EUT: CD04D
 Manuf: 6K012
 Op Cond: NEUTRAL
 Operator: ROSEN
 Test Spec: FOR CISPR22 CLASS B
 Comment: 110V/60Hz
 AV INPUT AND AV-3 OUTPUT MODE
 Result File: 6K012032.dat

Prescan Measurement: Detectors: X PK / + AV
 Meas Time: see scan settings
 Subranges: 8
 Acc Margin: 55 dB

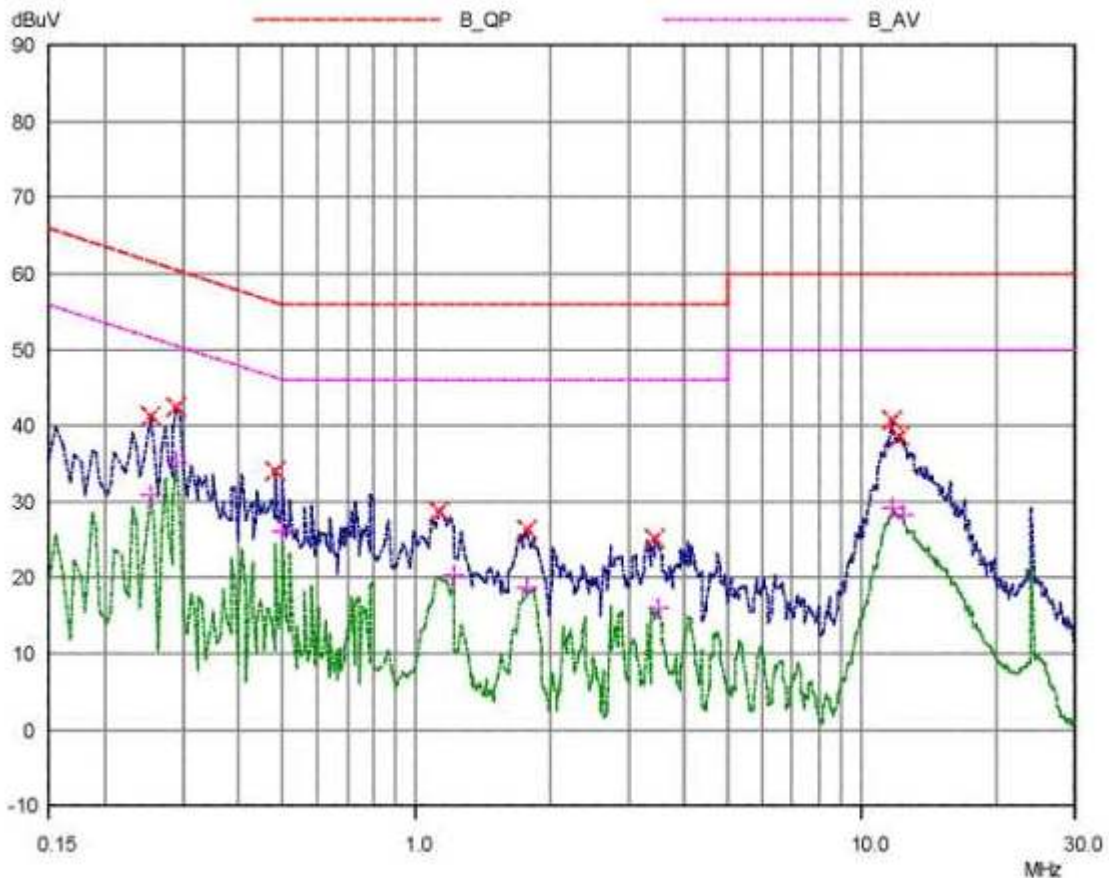



11 CONDUCTED POWER LINE TEST DATA (PAGE 4)

HomeTek EMC LAB. TEL :86-769-5303005 , 886-2-22608375

07 Dec 2007 10:02

CONDUCTED EMISSIONS

EUT: CD04D
 Manuf: 6K012
 Op Cond: NEUTRAL
 Operator: ROSEN
 Test Spec: FOR CISPR22 CLASS B
 Comment: 110V/60Hz
 AV INPUT AND AV-3 OUTPUT MODE
 Result File: 6K012032.dat

Prescan Measurement: Detectors: X PK / + AV
 Meas Time: see scan settings
 Subranges: 8
 Acc Margin: 55 dB

Peak Search Results

Frequency MHz	PK Level dBuV	PK Limit dBuV	PK Delta dB
0.25	41.32	61.76	20.44
0.29	42.47	60.52	18.05
0.4825	33.97	56.30	22.33
1.12	28.80	56.00	27.20
1.76	26.48	56.00	29.52
3.42	25.05	56.00	30.95
11.64	40.76	60.00	19.24
12.12	38.74	60.00	21.26

Frequency MHz	AV Level dBuV	AV Limit dBuV	AV Delta dB
0.25	30.99	51.76	20.77
0.29	35.36	50.52	15.16
0.502	26.07	46.00	19.93
1.2	20.47	46.00	25.53
1.78	18.71	46.00	27.29
3.5	16.11	46.00	29.89
11.76	29.25	50.00	20.75
12.3	28.19	50.00	21.81

* limit exceeded

RADIATED EMISSION TEST

1 TEST INSTRUMENTS & FACILITIES

The following test Instruments was used during the radiated emission test :

Item	Instruments /facilities	Specification	Manufacturer	Model # / S/N#	Date of Cal.
1	OPEN AREA TEST SITE	<input checked="" type="checkbox"/> OATS 3	HomeTek	N/A	DEC/2006
2	EMI TEST RECEIVER	20Hz ~ 5GHz	ROHED& SCHWARZ	ESBI 845636/007	DEC/2006
3	PRE-AMPLIFIER	9KHz ~1300MHz	HEWLETT PACKARD	8447D 1937A02095	DEC/2006
4	ANTENNA (BI-LOG)	30MHz ~ 2GHz	ANTENNA RESEACH	LPB2520/A 1095	MAR/2007
5	Attenuation	50Ω/6dB	JYE BAO	FAT-N(M-F) 001	DEC/2006
6	Cable	10m	SUHNER	RG214/U OS3-003	DEC/2006
7	Cable	14m	BELDEN	9913 OS3-001	DEC/2006
8	EMI 32 (software)	N/A	AUDIX	19991013-0923	N/A

Note : Items 1 ~ 7 were calibrated within period of 1 year.

2 TEST PROCEDURE

- 2.1 The EUT was test according to **ANSI C63.4 – 2003 Section 5.4, 5.5, 8.1, 8.2, 8.3 & CISPR 22 - 1997 & C18-01-11 (HomeTek test procedure)**.
- 2.2 The radiated test was performed at HomeTek Lab's Open Site 3.
- 2.3 The frequency range from 30 MHz to 1 GHz, the measurement were made at 10 meters, with a BI-log antenna.

3 TEST SETUP

3.1 TEST SETUP OF OPEN SITE.

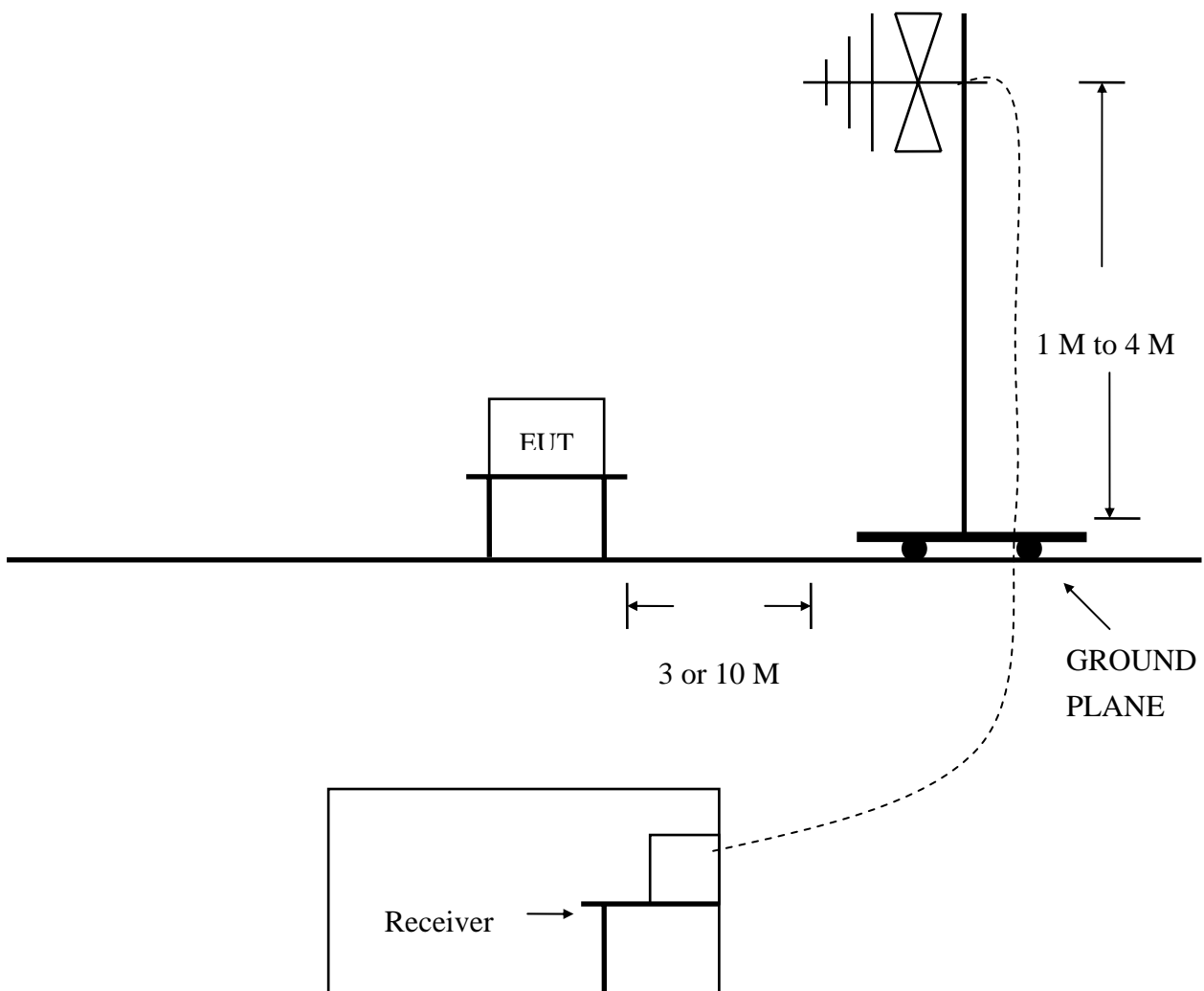

3.2 TEST SETUP OF EUT

ELECTRICAL AND ELECTRONIC EQUIPMENT IN THE RANGE OF 9kHz TO 40 GHz

ANSI
C63.4-2003

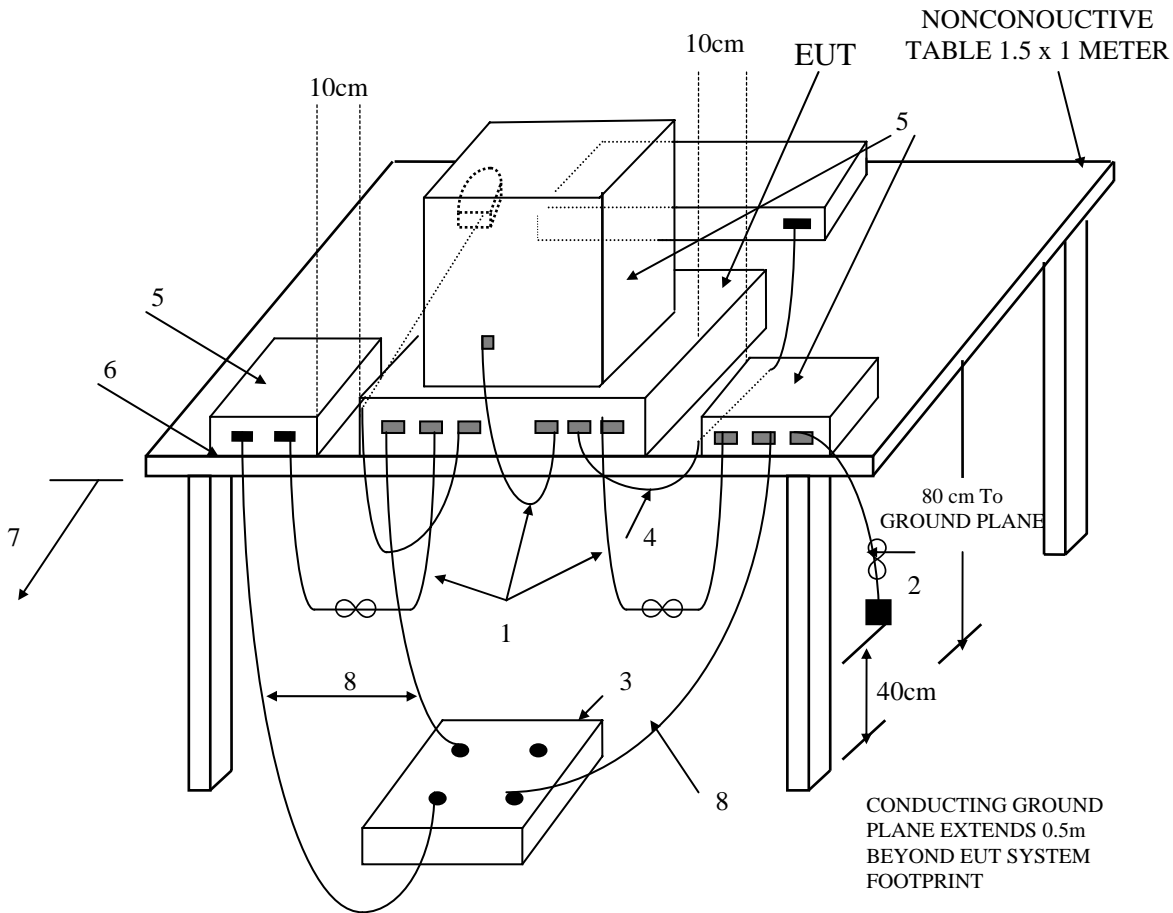

(Details for setup configuration, please refer to appendix A.)

LEGEND:

1. Interconnecting cables that hang closer than 40 cm to the ground plane shall be folded back and forth forming a bundle 30 to 40 cm long, hanging approximately in the middle between ground plane and table.
2. I/O cables that are connected to a peripheral shall be bundled in center. The end of the cable may be terminated if required using correct terminating impedance. The total length shall not exceed 1m.
3. If LISNs are kept in the test setup for radiated emissions, it is preferred that they be installed under the ground plane with the receptacle flush with the ground plane.
4. Cables of hand-operated devices, such as keyboards, mice, etc., have to be placed as close as possible to the controller.
5. Non-EUT components of EUT system being tested.
6. The rear of all components of the system under test shall be located flush with the rear of the table.
7. No vertical conducting wall used.
8. Power cords drape to the floor and are routed over to receptacle.

Test Configuration
Tabletop Equipment Radiated Emission

4 CONFIGURATION OF THE EUT

Same as “Conducted Power Line test”, section 4

5 EUT OPERATING CONDITION

5.1 Same as “Conducted Power Line test”, section 5

5.2 The radiated emission in the frequency range from 30 MHz - 1000 MHz was test in a horizontal and vertical polarization at HomeTek Lab’s open site 3.

5.3 The photos of radiated test configuration, please refer to appendix A.

6 LIMIT OF RADIATED EMISSION CLASS B

CISPR 22

Frequency (MHz)	Measurement Distance	Limit (dBuV/m)
30 - 230	10 (M)	30
230 - 1000	10 (M)	37

6.1 The tighter limit shall apply at the edge between two frequency bands.

6.2 Measurement distance in meters between the measuring instrument antenna and the closed point of any part of the EUT or peripherals.

7 RESULT OF RADIATED EMISSION TEST

- 7.1 The frequency range from 30 MHz to 1 GHz was investigated.
- 7.2 All readings below or equal 1 GHz are quasi-peak or peak values with resolution bandwidth of 120 KHz.
- 7.3 All readings above 1 GHz are average or peak values with resolution bandwidth of 1 MHz
- 7.4 The measurements were made at 10 meters of HomeTek Lab's open site 3.
- 7.5 Temperature : 22.4 °C, Humidity : 48 % RH.
- 7.6 Deviation form the test standards and rules : None
- 7.7 The radiation emission result were gained by the following method :
Level = Reading Level + Probe Factor (Antenna Factor) + Cable Loss – Preamp Factor
Over Limit = Level – Limit Line
- 7.8 The radiated mission test was passed at minimum margin :
Vertical 206.54 MHz/ 23.81 dBuV/m, Antenna Height 1.7 Meter,
Turn Table 172 degree, The Mode : AV input and AV-3 output Mode ,Model :
CD04D.
- 7.9 Result : **PASSED**

8 RADIATED EMISSION TEST DATA (PAGE 1)



HomeTek Technology Inc.

HomeTek Technology Inc.
Tel:02-22608375
Fax:02-22748013

Data#: 2 File#: 6K012.EMI

Date: 2007-12-07 Time: 16:55:34

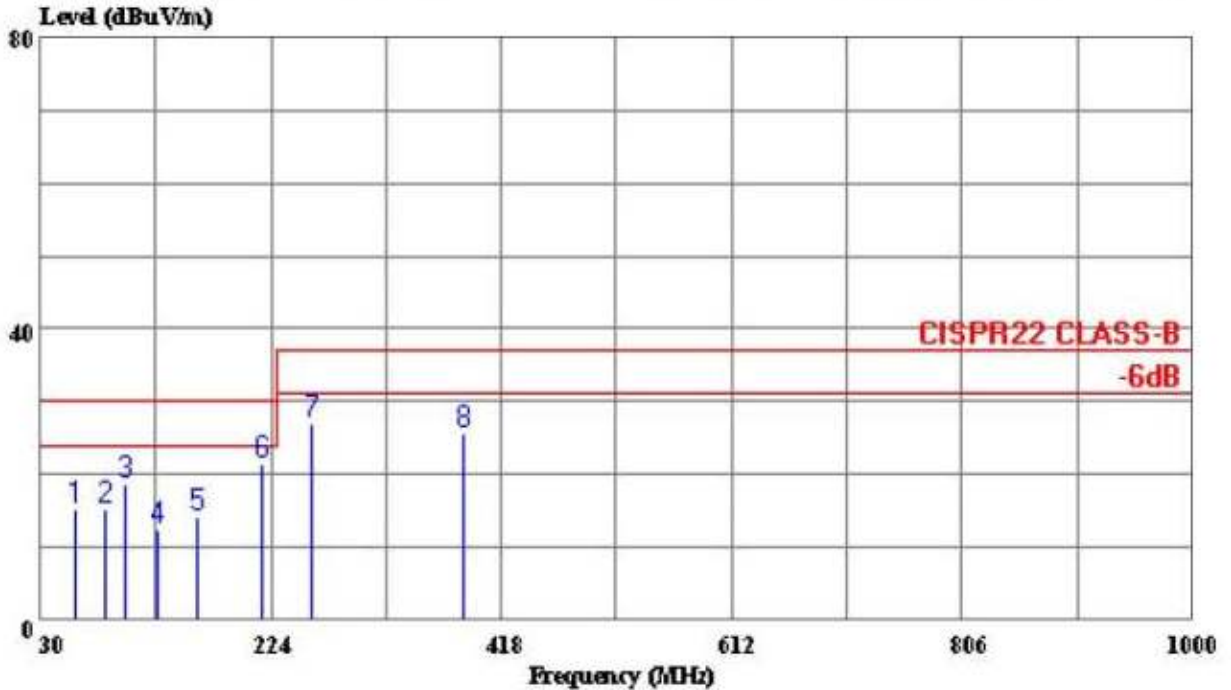

Trace:

Ref Trace:

Condition: CISPR22 CLASS-B 10m LPB-250/A-031028 HORIZONTAL
 out : CD04D
 power: 110V/60Hz
 memo : AV INPUT AND AV-3 OUTPUT MODE

Page: 1

	Freq	Level	Limit	Over	Read		Remark
	MHz	dBuV/m	dBuV/m	Limit	Level	Factor	
				dB	dBuV	dB	
1	60.070	15.13	30.00	-14.87	28.70	-13.57	Peak
2	84.320	15.19	30.00	-14.81	32.40	-17.21	QP
3	100.810	18.80	30.00	-11.20	36.00	-17.20	QP
4	128.940	12.44	30.00	-17.56	33.50	-21.06	Peak
5	162.890	14.29	30.00	-15.71	35.00	-20.71	Peak
6	217.210	21.38	30.00	-8.62	40.50	-19.12	Peak
7	257.950	27.02	37.00	-9.98	42.90	-15.88	Peak
8	386.960	25.53	37.00	-11.47	35.00	-9.47	Peak



9 RADIATED EMISSION TEST DATA (PAGE 2)



HomeTek Technology Inc.
Tel:02-22608375
Fax:02-22748013

HomeTek Technology Inc.

Data#: 1 File#: 6K012.EMI Date: 2007-12-07 Time: 16:08:07

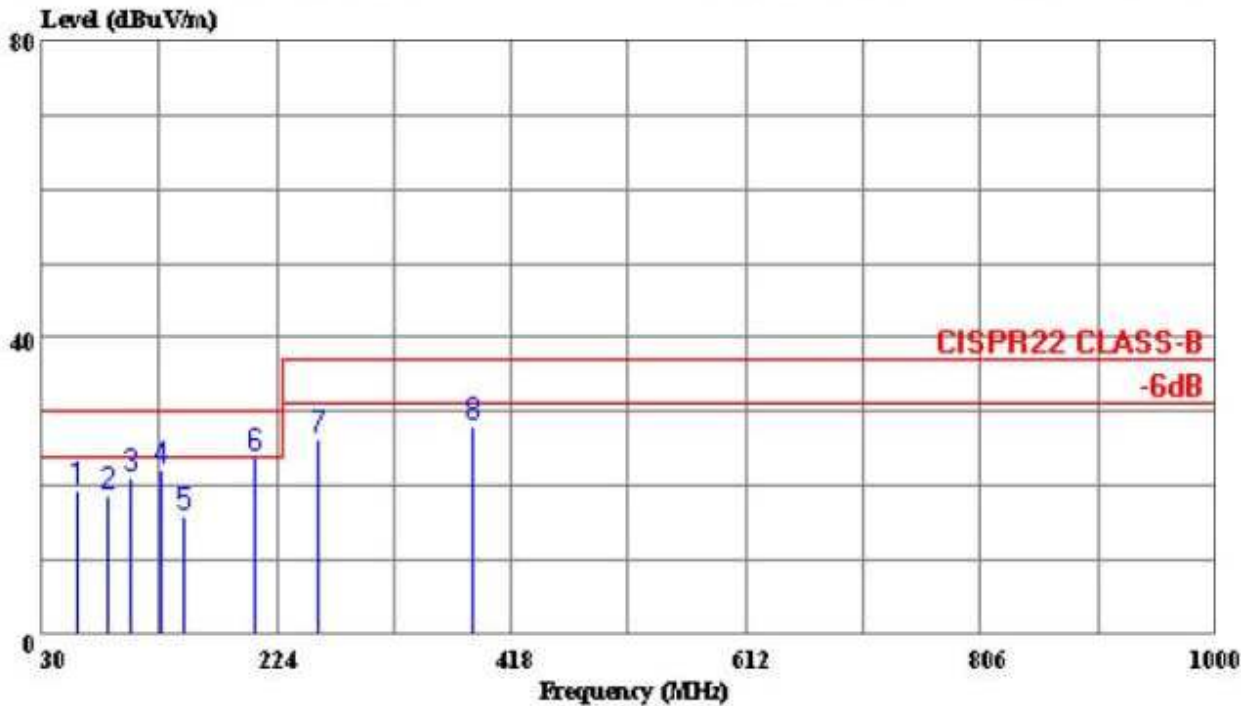

Trace:

Ref Trace:

Condition: CISPR22 CLASS-B 10m LPB-250/A-031028 VERTICAL
cut : CD04D
power: 110V/60Hz
memo : AV INPUT AND AV-3 OUTPUT MODE

Page: 1

	Freq	Level	Limit	Over	Read		Remark
	MHz	dBuV/m	dBuV/m	dB	dBuV	dB	
1	60.070	19.53	30.00	-10.47	35.20	-15.67	Peak
2	84.320	18.53	30.00	-11.47	35.40	-16.87	QP
3	102.750	21.21	30.00	-8.79	37.00	-15.79	QP
4	127.970	22.23	30.00	-7.77	39.50	-17.27	Peak
5	147.370	16.09	30.00	-13.91	37.10	-21.01	Peak
6	206.540	23.81	30.00	-6.19	38.70	-14.89	Peak
7	257.950	26.15	37.00	-10.85	41.40	-15.25	Peak
8	385.990	28.05	37.00	-8.95	38.00	-9.95	Peak

SAMPLE OF FCC DoC LABEL 1

This device complies with part 15 of the FCC Rules.
Operation is subject to the following two conditions: (1)
This device may not cause harmful interference. And (2)
this device must accept any interference received, including
interference that may cause undesired operation.

SAMPLE OF FCC DoC LABEL 2



Trade name
Model number



HomeTek Technology Inc.

Appendix A

PHOTOS OF TEST CONFIGURATION

PHOTO OF CONDUCTED POWER LINE TEST



Front View

PHOTO OF RADIATED EMISSION TEST



Front View



HomeTek Technology Inc.

Appendix B

PHOTOS OF EUT

PHOTO OF EUT



Front View of EUT

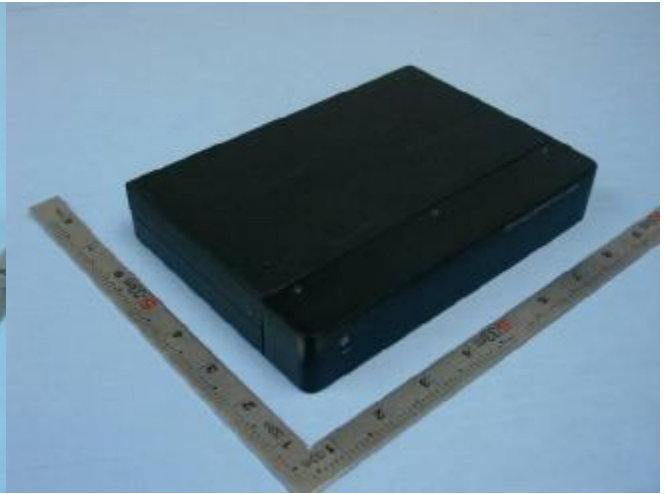

Rear View of EUT

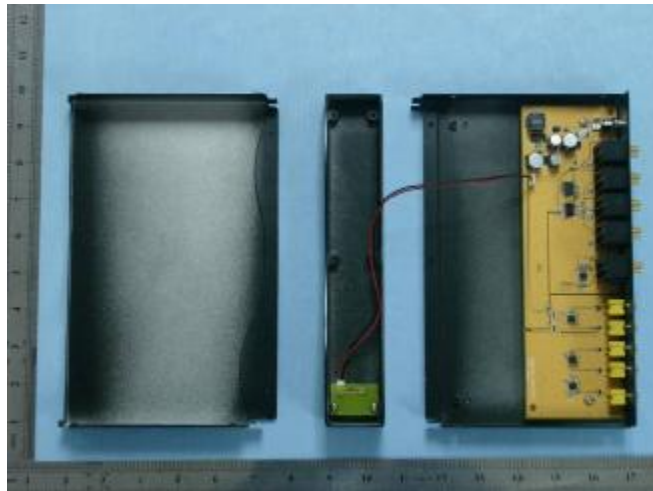

Inside View of EUT



Full View of Adapter

Declaration of Conformity

Responsible Party Name :

Address :

Phone No :

Fax No :

Declares under our sole responsibility that the product

Product Name : Multimedia AV Distribution Amplifier

Model No. : CD0XXX

to which this declaration relates is in conformity with the following standards or other normative documents

This device complies with Part 15 of the FCC Rules. Operation is subject to the following two conditions : (1) this device may not cause harmful interference, and (2) this device must accept any interference received, including interference that may cause undesired operation.

Representative Person's Name : _____

Signature : _____

Date : _____



UNITED STATES DEPARTMENT OF COMMERCE
National Institute of Standards and Technology
Gaithersburg, Maryland 20899

October 3, 2007

Mr. Grant Huang
HomeTek Technology Inc.
P.O Box: 13-131, Pan-Chiao City
No. 67-9 Shir Men Rd., Tu Chen City
Taipei Shien 236
TAIWAN

NVLAP Lab Code: 200331-0

Dear Mr. Huang:

I am pleased to inform you that continuing accreditation for specific test methods in EC&T : Electromagnetic Compatibility & Telecommunications is granted to your organization under the National Voluntary Laboratory Accreditation Program (NVLAP). This accreditation is effective until September 30, 2008, provided that your organization continues to comply with accreditation requirements contained in the NVLAP Procedures.

Your Certificate of Accreditation is enclosed along with a statement of your Scope of Accreditation. You may reproduce these documents in their entirety and announce your organization's accreditation status using the NVLAP logo in business publications, the trade press, and other business-oriented literature. Accreditation does not relieve your organization from observing and complying with any applicable existing laws and/or regulations.

We are pleased to have you participate in NVLAP and look forward to your continued association with this program. If you have any questions concerning your NVLAP accreditation, please direct them to Kurt B. Fischer, Sr. Program Manager, Laboratory Accreditation Program, National Institute of Standards and Technology, 100 Bureau Dr. Stop 2140, Gaithersburg, MD 20899-2140; (301) 975-4016.

Sincerely,

Sally S. Bruce, Chief
Laboratory Accreditation Program

Enclosure(s)





SCOPE OF ACCREDITATION TO ISO/IEC 17025:2005

HomeTek Technology Inc.
P.O Box: 13-131, Pan-Chiao City
No. 67-9 Shir Men Rd., Tu Chen City
Taipei Shien 236
TAIWAN

Mr. Grant Huang
Phone: 886-2-22608375 Fax: 886-2-22748013
E-Mail: hometek@ms15.hinet.net

**ELECTROMAGNETIC COMPATIBILITY
AND TELECOMMUNICATIONS**

NVLAP LAB CODE 200331-0

NVLAP Code Designation / Description

Emissions Test Methods:

12/CIS14a	EN 55014-1 (1993), A1 (1997), A2 (1999):
12/CIS14a2	BS EN 55014-1 (2001) with A1 and A2: Electromagnetic compatibility - Requirements for household appliances, electric tools and similar apparatus - Part 1: Emission
12/CIS14b1	AS/NZS CISPR 14-1 (2003): Electromagnetic Compatibility - Requirements for household appliances, electric tools and similar apparatus - Part 1: Emission
12/CIS14c	CNS 13783-1: Electromagnetic Compatibility Requirements for household appliances, electric tools and similar apparatus - Part 1: Emissions
12/CIS14d	IEC/CISPR 14-1 (2001) and A1 (2001): Electromagnetic Compatibility - Requirements for household appliances, electric tools and similar apparatus - Part 1: Emissions
12/CIS14x	IEC/CISPR 14-1, Ed. 4 (2003): Electromagnetic Compatibility - Requirements for household appliances, electric tools and similar apparatus - Part 1: Emission
12/CIS22	IEC/CISPR 22 (1997) & EN 55022 (1998) + A1(2000): Limits and methods of measurement of radio disturbance characteristics of information technology equipment

2007-10-01 through 2008-09-30

Effective dates

For the National Institute of Standards and Technology



**ELECTROMAGNETIC COMPATIBILITY
AND TELECOMMUNICATIONS**

NVLAP LAB CODE 200331-0

<i>NVLAP Code</i>	<i>Designation / Description</i>
12/CIS22a	IEC/CISPR 22 (1993) and EN 55022 (1994): Limits and methods of measurement of radio disturbance characteristics of information technology equipment, Amendment 1 (1995) and Amendment 2 (1996)
12/CIS22b	CNS 13438 (1997): Limits and Methods of Measurement of Radio Interference Characteristics of Information Technology Equipment
12/CIS22c	IEC/CISPR 22, Fourth Edition (2003-04) & EN 55022 (1998): Information technology equipment - Radio disturbance characteristics - Limits and methods of measurement
12/FCC15b	ANSI C63.4 (2003) with FCC Method 47 CFR Part 15, Subpart B: Unintentional Radiators
12/T51a	AS/NZS CISPR 22 (2004): Information technology equipment - Radio disturbance characteristics - Limits and methods of measurement
12/VCCIa	VCCI: Agreement of Voluntary Control Council for Interference by Information Technology Equipment - Technical Requirements: V-3/2005.04

2007-10-01 through 2008-09-30

Effective dates

For the National Institute of Standards and Technology

United States Department of Commerce
National Institute of Standards and Technology

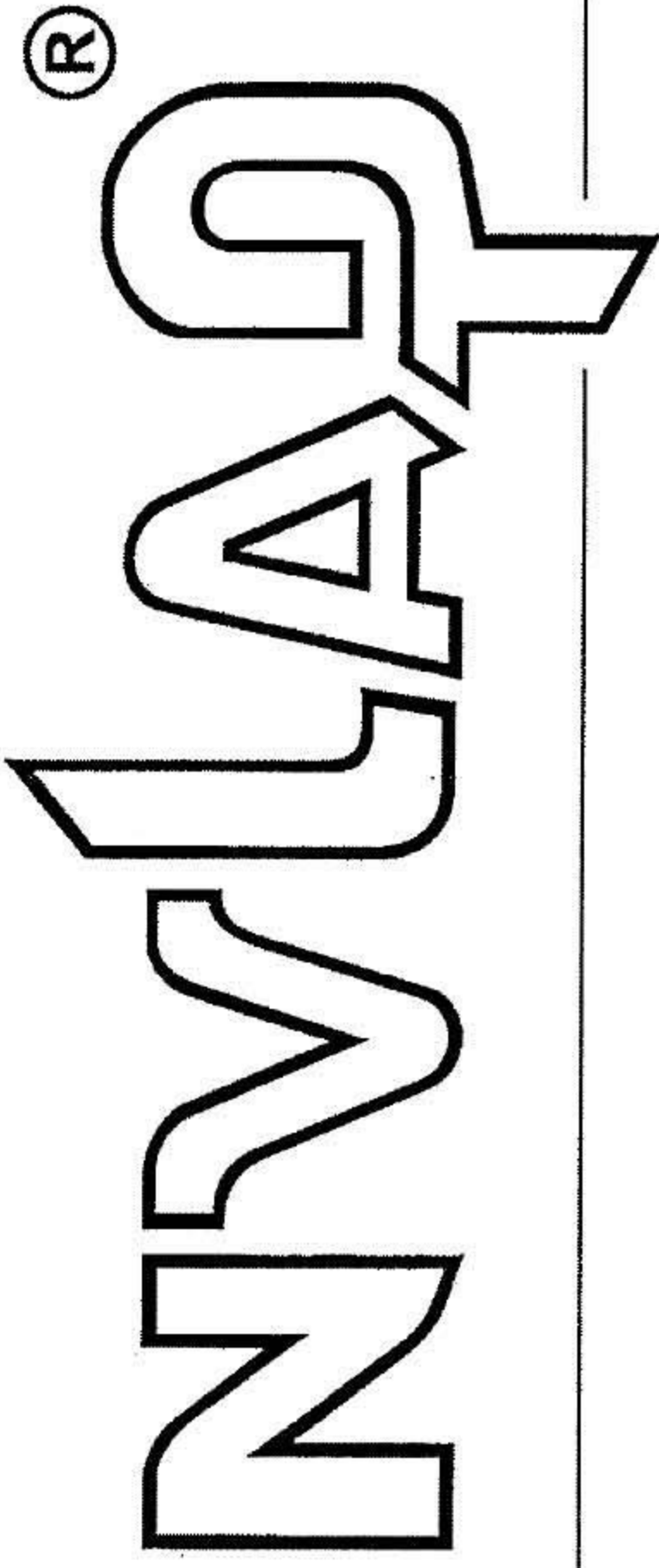

Certificate of Accreditation to ISO/IEC 17025:2005

NVLAP LAB CODE: 200331-0

HomeTek Technology Inc.

Taipei Shien 236

TAIWAN

is accredited by the National Voluntary Laboratory Accreditation Program for specific services,
listed on the Scope of Accreditation, for:

ELECTROMAGNETIC COMPATIBILITY AND TELECOMMUNICATIONS

*This laboratory is accredited in accordance with the recognized International Standard ISO/IEC 17025:2005.
This accreditation demonstrates technical competence for a defined scope and the operation of a laboratory quality
management system (refer to joint ISO-ILAC-IAF Communiqué dated 18 June 2005).*

2007-10-01 through 2008-09-30

Effective dates



Dolly S. Bruce

For the National Institute of Standards and Technology