



HomeTek Technology Inc.

ADDRESS: No. 67-9, Shir Men Road, Tu Cheng City,
Taipei Hsien, Taiwan,
PHONE : 886-2-22608375 FAX : 886-2-22748013
E - mail : hometek@ms15.hinet.net



NVLAP Lab Code:200331-0

EMI TEST REPORT FOR

APPLICANT : SMART CABLING & TRANSMISSION CORP.
ADDRESS : 10F, No. 493, Chung-Cheng Rd.,
Hsin Tien City, Taipei 231, Taiwan, R. O. C.
EUT : Video Distribution Amplifier
MODEL NO. : CD40XXX

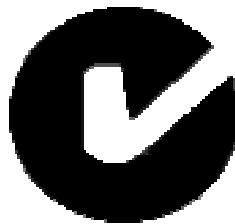

MEASUREMENT PROCEDURE USED

AS/NZS CISPR 22: 2004 Information technology equipment – Radio disturbance characteristics – Limits and methods of measurement

PREPARED BY :
HomeTek Technology Inc.
No. 67-9, Shir Men Road, Tu Cheng City,
Taipei Hsien. Taiwan
Report # : AS5F019



TABLE OF CONTENTS..... 2

CERTIFICATE 3

GENERAL INFORMATION..... 4

MODIFICATION LIST..... 5

CONDUCTED POWER LINE TEST 6

1 TEST INSTRUMENTS & FACILITIES..... 6

2 TEST PROCEDURE..... 6

3 TEST SETUP 7

4 CONFIGURATION OF THE EUT 9

5 EUT OPERATING CONDITION..... 16

6 LIMIT OF CONDUCTED POWER LINE EMISSION CLASS B..... 17

7 RESULT OF CONDUCTED POWER LINE TEST..... 17

8 CONDUCTED POWER LINE TEST DATA (PAGE 1)..... 18

9 CONDUCTED POWER LINE TEST DATA (PAGE 2)..... 19

10 CONDUCTED POWER LINE TEST DATA (PAGE 3)..... 20

11 CONDUCTED POWER LINE TEST DATA (PAGE 4)..... 21

RADIATED EMISSION TEST..... 22

1 TEST INSTRUMENTS & FACILITIES..... 22

2 TEST PROCEDURE..... 23

3 TEST SETUP 23

4 CONFIGURATION OF THE EUT 25

5 EUT OPERATING CONDITION..... 25

6 LIMIT OF RADIATED EMISSION CLASS B 25

7 RESULT OF RADIATED EMISSION TEST..... 25

8 RADIATED EMISSION TEST DATA (PAGE 1)..... 26

9 RADIATED EMISSION TEST DATA (PAGE 2)..... 27

APPENDIX A

PHOTOS OF TEST CONFIGURATION

APPENDIX B

PHOTOS OF EUT

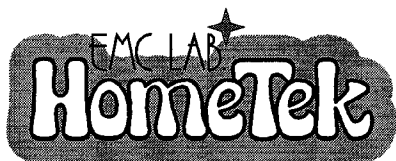

HomeTek Technology Inc.

ADDRESS: No. 67-9, Shir Men Road, Tu Cheng City,
Taipei Hsien, Taiwan

PHONE : 886-2-22608375 FAX : 886-2-22748013

E - mail : hometek@ms15.hinet.net



CERTIFICATE

APPLICANT : SMART CABLING & TRANSMISSION CORP.
 ADDRESS : 10F, No. 493, Chung-Cheng Rd.,
Hsin Tien City, Taipei 231, Taiwan, R. O. C.
 Receipt Date : 06/15/2006 Final Test Date: 06/22/2006
 EUT : Video Distribution Amplifier
 MODEL NO. : CD40XXX

MEASUREMENT PROCEDURE USED :

AS/NZS CISPR 22: 2004 Information technology equipment – Radio
disturbance characteristics – Limits and methods of measurement

- THE MAXIMUM EMISSION LEVELS WERE COMPARED TO THE CISPR 22 CLASS B LIMITS BOTH RADIATED AND CONDUCTED EMISSION.
- THE ABOVE DEVICE WAS TESTED BY HOMETEK TECHNOLOGY INC. TO SHOWS THE MAXIMUM EMISSION LEVEL FROM THE DEVICE.
- THIS TEST RESULTS OF THIS REPORT APPLIES TO ABOVE TESTED SAMPLE ONLY.
- THIS TEST REPORT SHALL NOT BE REPRODUCE IN PART WITHOUT WRITTEN APPROVAL OF HOMETEK TECHNOLOGY INC.
- THE REPORT MUST NOT BE USED BY THE CLIENT TO CLAIM PRODUCT ENDORSEMENT BY NVLAP OR ANY AGENCY OF THE U. S. GOVERNMENT.
- THE TEST RESULTS ARE TRACEABLE TO THE NATIONAL OR INTERNATIONAL STANDARD.

APPROVED BY :

Albert Tsai 06/29/2006
ALBERT TSAI / Senior Engineer

GENERAL INFORMATION

- 1 APPLICANT : SMART CABLING & TRANSMISSION CORP.
- 2 ADDRESS : 10F, No. 493, Chung-Cheng Rd.,
Hsin Tien City, Taipei 231, Taiwan, R. O. C.
- 3 MANUFACTURER : SMART CABLING & TRANSMISSION CORP.
- 4 ADDRESS : 10F, No. 493, Chung-Cheng Rd.,
Hsin Tien City, Taipei 231, Taiwan, R. O. C.
- 5 DESCRIPTION OF EUT :
- EUT : Video Distribution Amplifier
- Model Number : CD40XXX
- Serial # : N/A

5.1 The difference between series of models CD40XXX are as shown below:

C D 4 0 X X X

- (1) The first "X" represent different system input.
- (2) The second "X" represent different accessory.
- (3) The third "X" represent different color.

The PCB layout is similar. The worst case of model is CD408A, and the final test data were shown in this test report.

- 6 FEATURES OF EUT :

Please refer to user manual or product specification.



HomeTek Technology Inc.

MODIFICATION LIST

THE FOLLOWING ACCESSORIES WERE ADDED TO THE EUT DURING TESTING :

NO MODIFICATION BY HOMETEK TECHNOLOGY INC.

CONDUCTED POWER LINE TEST

1 TEST INSTRUMENTS & FACILITIES

The following test Instruments was used during the conducted test :

Item	Instruments/ Facilities	Specification	Manufacturer	Model # S/N	Date Of Cal.
1	EMI Receiver	9KHz ~ 30MHz	ROHDE & SCHWARZ	ESHS 30 844827/007	FEB/2006
2	LISN (for EUT)	50Ω/50uH/100A 150KHz ~ 30MHz	SCHWARZ BECK	NNLK 8121 8121370	OCT/2005
3	LISN (for Support Unit)	50Ω/50uH/10A 9KHz ~ 30MHz	ROHDE & SCHWARZ	ESH3-Z5 846128/007	MAR/2006
4	Terminator	50Ω	N/A	N/A	NOV/2005
5	Attenuation	50Ω/10dB	Mini-Circuit	NAT-10 AT-002	JUL/2005
6	Cable	5.4m	SUHNER	RG-223 CON2-002	AUG/2005
7	ESXS-K1 (software)	Version 2.03b 9KHz ~ 30MHz	ROHDE & SCHWARZ	1082.9678.02 840.913/246	N/A

Note : Items 1 ~ 6 were calibrated within period of 1 year.

2 TEST PROCEDURE

- 2.1 The EUT was tested according to **AS/NZS CISPR 22**.
- 2.2 The EUT was placed 0.4 meter from the conducting wall of shielding room and kept at least 0.8 meter from any other grounded conducting surface.
- 2.3 The frequency range form 0.15 MHz to 30 MHz was investigated.
- 2.4 The LISN used was 50 Ohm / 50 uHenry as specified of **AS/NZS CISPR 22**.
- 2.5 All the support peripherals are connect to the other LISN.
- 2.6 Cables and peripherals were moved to find the maximum emission levels for each frequency.

3 TEST SETUP

3.1 Typical : Setup Of Conducted Test

ELECTRICAL AND ELECTRONIC EQUIPMENT IN THE RANGE OF 9kHz TO 40 GHz AS/NZS CISPR 22

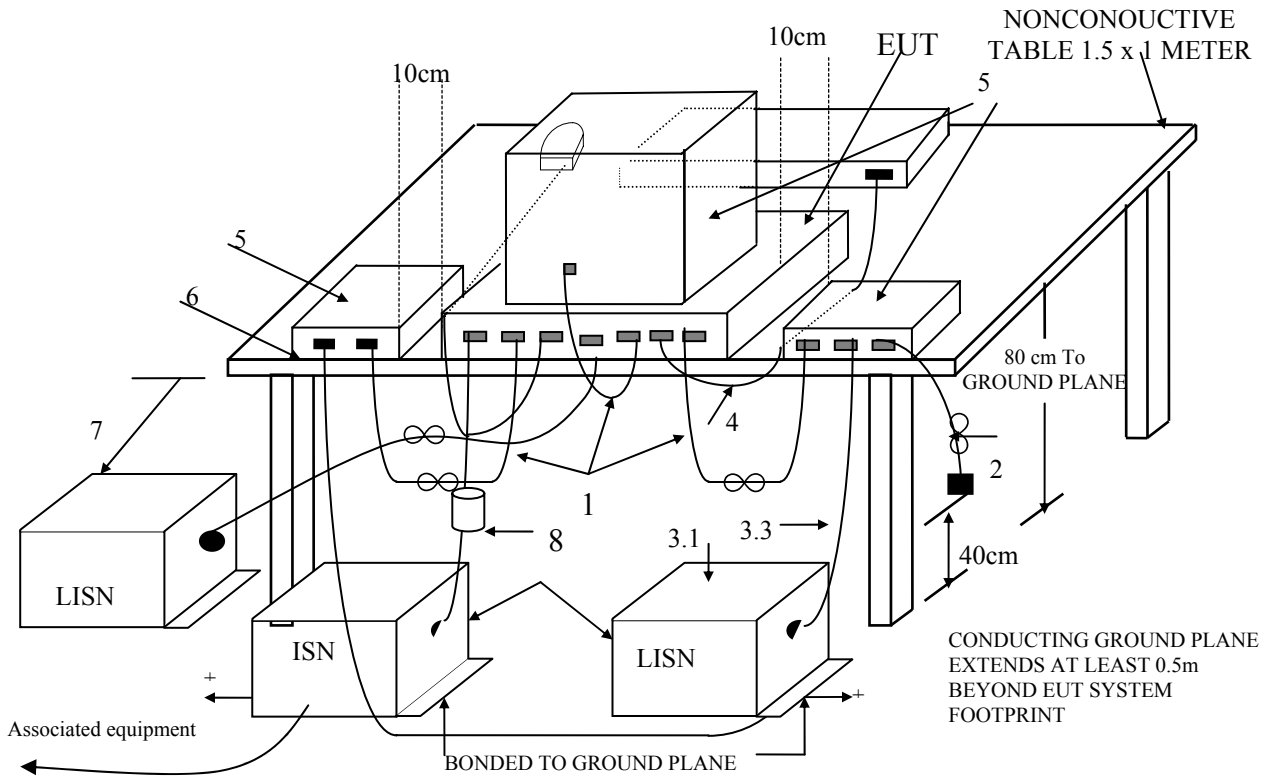

+LISNs may have to be moved to the side to meet 3.3 below.

(Details for setup configuration, please refer to appendix A.)

LEGEND:

1. If cables, which hang closer than 40 cm to the horizontal metal groundplane, cannot be shortened to appropriate length, the excess shall be folded back and forth forming a bundle 30 cm to 40 cm long.
2. Excess mains cord shall be bundled in the centre or shortened to appropriate length.
3. EUT is connected to one artificial mains network (AMN). All AMNs and ISNs may alternatively be connected to a vertical reference plane or metal wall.
 - 3.1 All other units of a system are powered from a second AMN. A multiple outlet strip can be used for multiple mains cords.
 - 3.2 AMN and ISN are 80 cm from the EUT and at least 80 cm from other units and other metal planes.
 - 3.3 Mains cords and signal cables shall be positioned for their entire lengths, as far as possible, at 40 cm from the vertical reference plane.
4. Cables of hand-operated devices, such as keyboards, mice, etc., have to be placed as close as for normal usage.
5. Peripherals shall be placed at a distance of 10 cm from each other and from the controller, except for the monitor which, if this is an acceptable installation practice, shall be placed directly on the top of the controller.
6. I/O signal cable intended for external connection.
7. The end of the I/O signal cables which are not connected to an AE may be terminated, if required, using correct terminating impedance.
8. If used, the current probe shall be placed at 0.1 m from the ISN.

**Test Configuration
Tabletop Equipment Conducted Emission**

3.2 Block Diagram Of Conducted Test

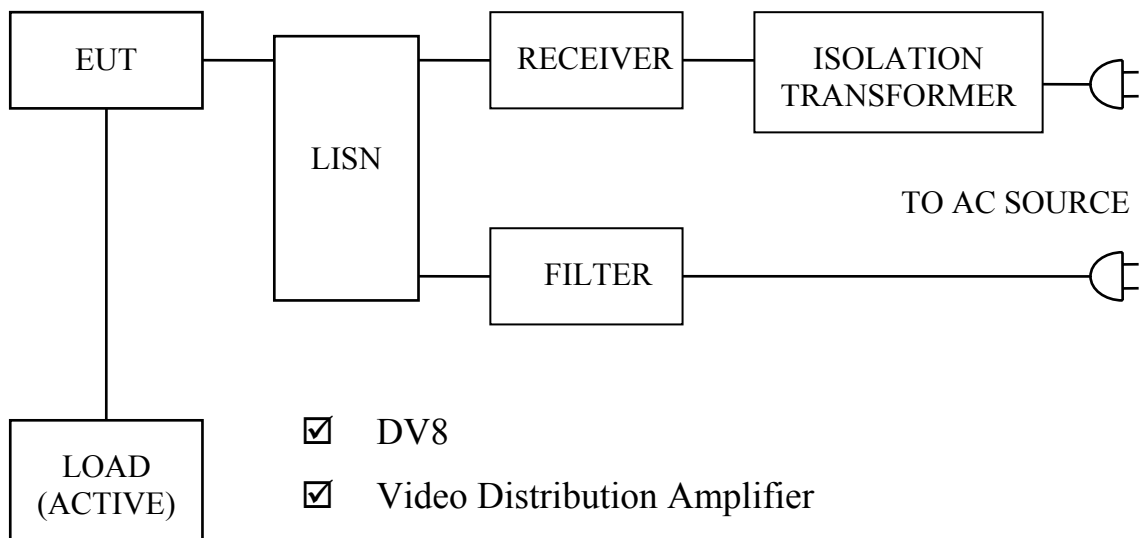

- DV8
- Video Distribution Amplifier
- Video Amplifier
- Power Center
- CAT5 AV Multimedia Transmission
- Terminator
- TV
- Adapter
- Video Distributor

4.1 EUT

EUT Type : Proto Type Engineer Type Mass Production
 Condition when received : Good Damage : _____
 Device : Video Distribution Amplifier
 Applicant : SMART CABLING & TRANSMISSION CORP.
 Manufacturer : SMART CABLING & TRANSMISSION CORP.
 Model Number : CD40XXX
 Serial Number : N/A
 FCC ID : N/A
 Video Input Port x 4 : Metal Type Connector
 Video Output Port x 8 : Metal Type Connector
 Power Cord (AC) : 2 pin
 Power Cord (DC) : Un-Shielded, 1.8 m, 2 pin
 Power Supply Type : Linear

4.2 PERIPHERALS

DV8

Manufacturer : SONY
 Model Number : DCR-PC110
 Serial Number : 1158142
 FCC ID : FCC DoC
 Data Cable : Shielded, 1.8 m, Connected to the coaxial port
 Power Cord : N/A



Video Distribution Amplifier

Manufacturer : SMART CABLING & TRANSMISSION CORP.
Model Number : CD1664
Serial Number : N/A
FCC ID : N/A
Data Cable : Shielded, 1.0 m, Connected to the coaxial port
Power Cord : Un-Shielded, 1.8 m

Video Distribution Amplifier

Manufacturer : SMART CABLING & TRANSMISSION CORP.
Model Number : CD102
Serial Number : N/A
FCC ID : N/A
Data Cable x 2 : Shielded, 1.0 m, Connected to the Video Input Port
Power Cord : Un-Shielded, 1.8 m

Video Amplifier

Manufacturer : SMART CABLING & TRANSMISSION CORP.
Model Number : CA101
Serial Number : N/A
FCC ID : N/A
Data Cable : Shielded, 1.0 m, Connected to the Video Output Port
Power Cord : Un-Shielded, 1.8 m



Video Amplifier

Manufacturer : SMART CABLING & TRANSMISSION CORP.
Model Number : CA404
Serial Number : N/A
FCC ID : N/A
Data Cable x 4 : Shielded, 1.0 m, Connected to the Video Output Port
Power Cord : Un-Shielded, 1.8 m

Video Distribution Amplifier

Manufacturer : SMART CABLING & TRANSMISSION CORP.
Model Number : CD816
Serial Number : N/A
FCC ID : N/A
Data Cable x 3 : Shielded, 1.0 m, Connected to the Video Output Port
Power Cord : Un-Shielded, 1.8 m

Power Center

Manufacturer : SMART CABLING & TRANSMISSION CORP.
Model Number : PR816
Serial Number : N/A
FCC ID : N/A
Data Cable : N/A
Power Cord (AC) : Un-Shielded, 1.8 m
Power Cord (DC) : Un-Shielded, 0.2 m



CAT5 AV Multimedia Transmission

Manufacturer : SMART CABLING & TRANSMISSION CORP.
Model Number : TTP111RGB
Serial Number : N/A
FCC ID : N/A
Data Cable : Shielded, 1.0 m, Connected to the coaxial port
Power Cord : N/A

CAT5 AV Multimedia Transmission

Manufacturer : SMART CABLING & TRANSMISSION CORP.
Model Number : TTP111CVB
Serial Number : N/A
FCC ID : N/A
Data Cable x 2 : Shielded, 1.0 m, Connected to the Video Input Port
Power Cord : N/A

Terminator

Manufacturer : HomeTek
Model Number : 75Ω
Serial Number : N/A
FCC ID : N/A
Data Cable : Shielded, 1.8 m, Connected to the coaxial port
Power Cord : N/A



TV

Manufacturer : TCL
Model Number : 1419A
Serial Number : N/A
FCC ID : N/A
Data Cable : Shielded, 1.8 m, Connected to the coaxial port
Power Cord : Un-Shielded, 1.8 m

Video Distributor

Manufacturer : SMART CABLING & TRANSMISSION CORP.
Model Number : 15-VD14
Serial Number : N/A
FCC ID : N/A
Data Cable : Shielded, 1.8 m, Connected to the coaxial port
Power Cord : Un-Shielded, 1.8 m

Adapter for CD1664

Manufacturer : YUH NIAN
Model Number : HPA-501242U3 A2
Serial Number : N/A
FCC ID : N/A
Data Cable : N/A
Power Cord (AC) : Un-Shielded, 1.8 m
Power Cord (DC) : Shielded, 1.0 m



Adapter

Manufacturer : Atech
Model Number : RH41-1250500DG
Serial Number : N/A
FCC ID : N/A
Data Cable : N/A
Power Cord (DC) : Un-Shielded, 1.8 m

Monitor x 2 (Remote Site)

Manufacturer : SMART CABLING & TRANSMISSION CORP.
Model Number : MT14A
Serial Number : N/A
FCC ID : N/A
Data Cable : Shielded, 10 m, Connected to the coaxial port
Power Cord : Un-Shielded, 1.8 m

4.3 REMARK : N/A

5 EUT OPERATING CONDITION

- 5.1 The frequency of the EUT is none.
- 5.2 Configure the EUT according to the **AS/NZS CISPR 22**.
- 5.3 The operation condition of EUT, Please refer to section 4.
- 5.4 Support unit 1 represent Video Distributor(15-VD14).
Support unit 2 represent CAT5 AV Multimedia Transmission(TTP111RGB).
Support unit 3 represent Video Distribution Amplifier(CD102).
Support unit 4 represent CAT5 AV Multimedia Transmission(TTP111CVB).
Support unit 5 represent Video Amplifier(CA404).
Support unit 6 represent Video Amplifier(CA101).
Support unit 7 represent Video Distribution Amplifier(CD816).
Support unit 8 represent Video Distribution Amplifier(CD1664).
- 5.5 DV gives color Bar signal to Support unit 1 via Video Port.
- 5.6 Support unit 1 is video distributors with one video input to three video output and transmits the signal to Support unit 2 via three video ports.
- 5.7 Support unit 2 transforms three video signals(input) into CAT 5 signal(output) then Support unit 2 transmits CAT 5 signal to Support unit 4 via one CAT 5 UTP cable.
- 5.8 Support unit 4 transforms CAT 5 signal(input) into three video signals(output) then Support unit 4 transmits video signal to Support unit 3 via one coaxial cable and EUT via two coaxial cable.
- 5.9 Support unit 3 is video distributors with one video input to two video output and transmits the signal to EUT via two video ports.
- 5.10 EUT receives four video signal through Support unit 4 and Support unit 3, then it transforms four video signals(input) into eight video signals(output).
- 5.11 EUT transmits four video signals to Support unit 5 via four coaxial cables.
- 5.12 EUT transmits one video signal to Support unit 6 via one coaxial cable.
- 5.13 EUT transmits three video signals to Support unit 7 via three coaxial cables.
- 5.14 Support unit 5 receives four video signals through EUT then it transmits and amplifies four video signals(input) to Support unit 7 via coaxial cables.
- 5.15 Support unit 6 receives video signal through EUT then it transmits and amplifies video signal(input) to Support unit 7 via coaxial cable.
- 5.16 Support unit 7 receives video signal through EUT, Support unit 5 and Support unit 6.
- 5.17 Support unit 7 is video distributors with eight video input to sixteen video output and transmits the signals to Support unit 8 via coaxial cables.
- 5.18 Support unit 8 is video distributors with sixteen video inputs to sixty-four video outputs and transmits one signal to TV via coaxial cables and two signals to remote side (two Monitor) via 10m coaxial cable.
- 5.19 TV displays Color Bar.
- 5.20 Thirteen ports of Support unit 8 connects with terminator (75ohm).
- 5.21 The other ports are verified that they are not high incidence of EMC characteristic.
- 5.22 Measure the emission noise.
- 5.23 The photos of conducted test configuration, please refer to appendix A.**

6 LIMIT OF CONDUCTED POWER LINE EMISSION CLASS B

AS/NZS CISPR 22

Frequency Range	Quasi Peak	Average
0.15 ~ 0.5 MHz	66 - 56 dBuV	56 - 46 dBuV
0.5 ~ 5 MHz	56 dBuV	46 dBuV
5 ~ 30 MHz	60 dBuV	50 dBuV

6.1 In the above table, the tighter limit applies at the band edges.

7 RESULT OF CONDUCTED POWER LINE TEST

7.1 The frequency range from 0.15 MHz to 30 MHz was investigated. All readings are quasi-peak values and average.

7.2 IF bandwidth : 9 kHz, Meas Time : 1 sec.

7.3 Temperature : 26 °C, Humidity : 54 % RH.

7.4 Uncertainty in conducted emission measurement : ± 2.90 dB.

7.5 The conducted test result were gained by following procedures :
 Level = Reading Level + Insertion Loss of LISN + Cable Loss
 (All calculation were done by ESHS30 EMI test receiver.)

7.6 Result : **PASSED**

8 CONDUCTED POWER LINE TEST DATA (PAGE 1)

HomeTek EMC LAB. TEL :886-2-22608375

15 Jun 2006 18:40

CONDUCTED EMISSIONS

EUT: Video Distribution Amplifier
 Manuf: 5F019
 Op Cond: LINE 1
 Operator: CHAD
 Test Spec: FOR CISPR22 CLASS B
 Comment: 240V/50Hz
 CD408A
 Result File: 5f01911g.dat : CD408A

Prescan Measurement: Detectors: X PK / + AV
 Meas Time: see scan settings
 Subranges: 16
 Acc Margin: 55 dB

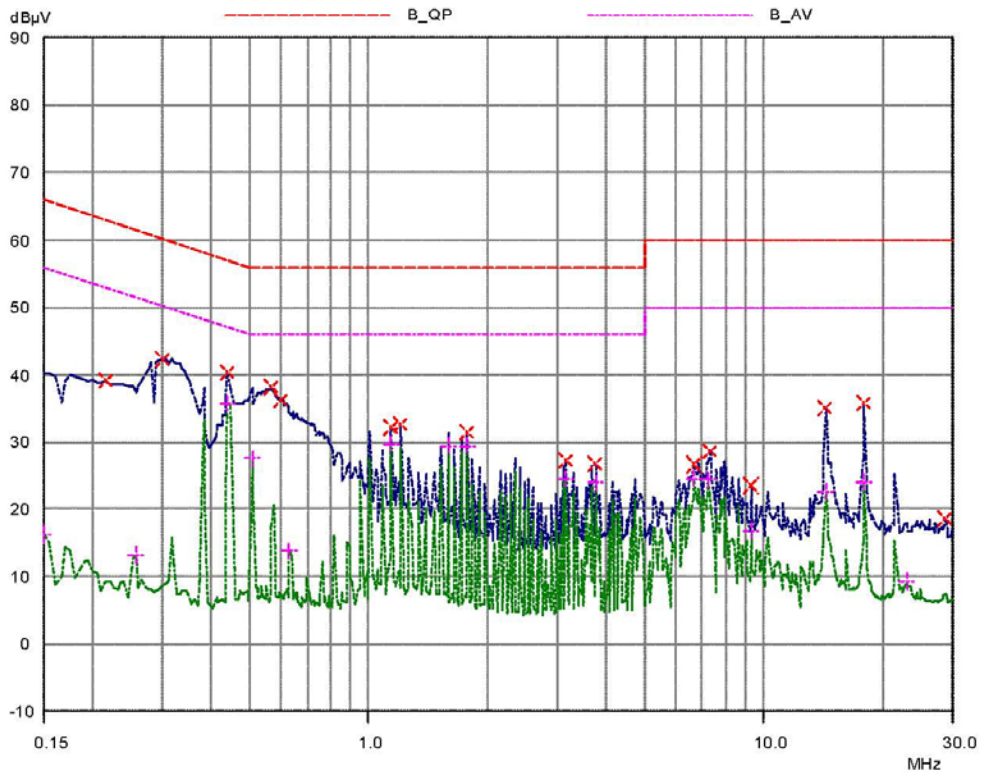



9 CONDUCTED POWER LINE TEST DATA (PAGE 2)

HomeTek EMC LAB. TEL :886-2-22608375

15 Jun 2006 18:40

CONDUCTED EMISSIONS

EUT: Video Distribution Amplifier
 Manuf: 5F019
 Op Cond: LINE 1
 Operator: CHAD
 Test Spec: FOR CISPR22 CLASS B
 Comment: 240V/50Hz
 CD408A
 Result File: 5f01911g.dat : CD408A

Prescan Measurement: Detectors: X PK / + AV
 Meas Time: see scan settings
 Subranges: 16
 Acc Margin: 55 dB

Peak Search Results

Frequency MHz	PK Level dBµV	PK Limit dBµV	PK Delta dB
0.215	39.20	63.01	23.81
0.3	42.39	60.24	17.85
0.44	40.43	57.06	16.63
0.565	38.23	56.00	17.77
0.6	36.36	56.00	19.64
1.14	32.31	56.00	23.69
1.2	32.79	56.00	23.21
1.77	31.58	56.00	24.42
3.16	27.16	56.00	28.84
3.73	26.64	56.00	29.36
6.64	26.63	60.00	33.37
7.33	28.68	60.00	31.32
9.23	23.48	60.00	36.52
14.3	35.16	60.00	24.84
17.93	35.78	60.00	24.22
28.62	18.48	60.00	41.52

Frequency MHz	AV Level dBµV	AV Limit dBµV	AV Delta dB
0.15	16.28	56.00	39.72
0.255	13.15	51.59	38.44
0.44	35.79	47.06	11.27
0.505	27.52	46.00	18.48
0.63	13.84	46.00	32.16
1.14	29.79	46.00	16.21
1.58	29.61	46.00	16.39
1.77	29.52	46.00	16.48
3.16	24.49	46.00	21.51
3.73	23.89	46.00	22.11
6.64	24.50	50.00	25.50
7.21	24.36	50.00	25.64
9.23	16.85	50.00	33.15
14.35	22.60	50.00	27.40
17.93	24.02	50.00	25.98
22.83	9.33	50.00	40.67

* limit exceeded

10 CONDUCTED POWER LINE TEST DATA (PAGE 3)

HomeTek EMC LAB. TEL :886-2-22608375

15 Jun 2006 18:44

CONDUCTED EMISSIONS

EUT: Video Distribution Amplifier
 Manuf: 5F019
 Op Cond: LINE 2
 Operator: CHAD
 Test Spec: FOR CISPR22 CLASS B
 Comment: 240V/50Hz
 CD408A
 Result File: 5f01921g.dat : CD408A

Prescan Measurement: Detectors: X PK / + AV
 Meas Time: see scan settings
 Subranges: 16
 Acc Margin: 55 dB

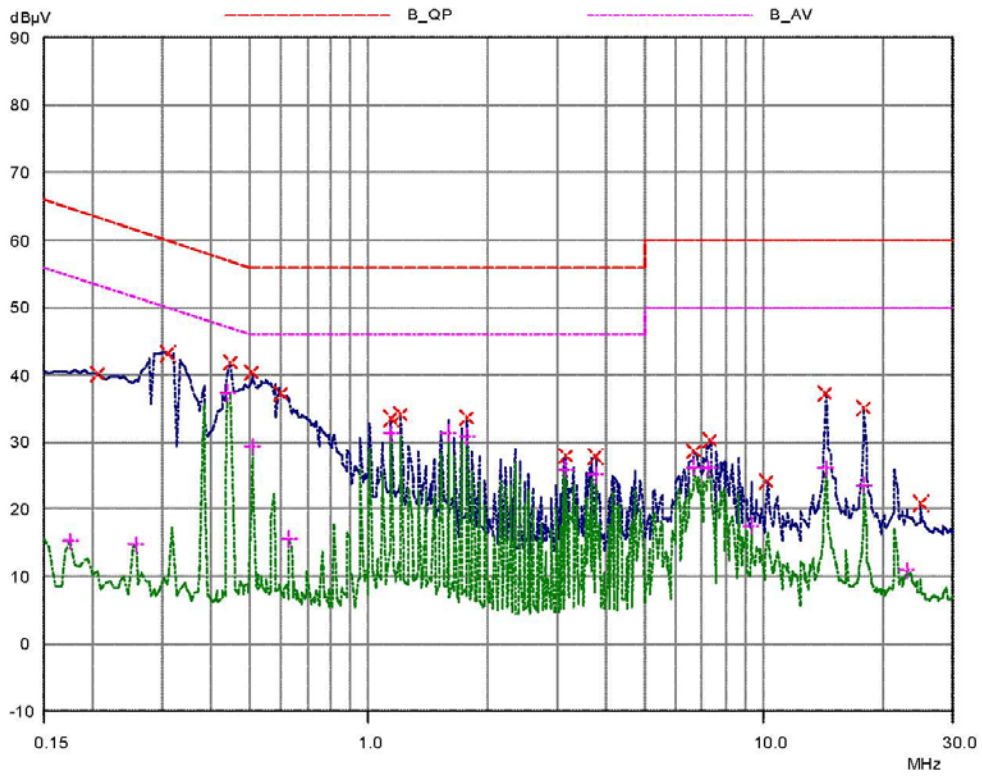



11 CONDUCTED POWER LINE TEST DATA (PAGE 4)

HomeTek EMC LAB. TEL :886-2-22608375

15 Jun 2006 18:44

CONDUCTED EMISSIONS

EUT: Video Distribution Amplifier
 Manuf: 5F019
 Op Cond: LINE 2
 Operator: CHAD
 Test Spec: FOR CISPR22 CLASS B
 Comment: 240V/50Hz
 CD408A
 Result File: 5f01921g.dat : CD408A

Prescan Measurement: Detectors: X PK / + AV
 Meas Time: see scan settings
 Subranges: 16
 Acc Margin: 55 dB

Peak Search Results

Frequency MHz	PK Level dBµV	PK Limit dBµV	PK Delta dB
0.205	40.25	63.41	23.16
0.31	43.19	59.97	16.78
0.445	41.92	56.97	15.05
0.505	40.35	56.00	15.65
0.6	37.21	56.00	18.79
1.14	33.59	56.00	22.41
1.2	34.10	56.00	21.90
1.77	33.78	56.00	22.22
3.16	27.93	56.00	28.07
3.73	27.82	56.00	28.18
6.64	28.56	60.00	31.44
7.33	30.25	60.00	29.75
10.18	24.14	60.00	35.86
14.35	37.33	60.00	22.67
17.88	35.08	60.00	24.92
25.06	20.84	60.00	39.16

Frequency MHz	AV Level dBµV	AV Limit dBµV	AV Delta dB
0.175	15.22	54.72	39.50
0.255	14.80	51.59	36.79
0.44	37.43	47.06	9.63
0.505	29.43	46.00	16.57
0.63	15.57	46.00	30.43
1.14	31.39	46.00	14.61
1.58	31.43	46.00	14.57
1.77	30.93	46.00	15.07
3.16	25.93	46.00	20.07
3.73	25.11	46.00	20.89
6.64	26.22	50.00	23.78
7.21	26.08	50.00	23.92
9.23	17.56	50.00	32.44
14.35	26.02	50.00	23.98
17.93	23.54	50.00	26.46
22.89	10.91	50.00	39.09

* limit exceeded

RADIATED EMISSION TEST

1 TEST INSTRUMENTS & FACILITIES

The following test Instruments was used during the radiated emission test :

Item	Instruments /facilities	Specification	Manufacturer	Model # / S/N#	Date of Cal.
1	OPEN AREA TEST SITE	<input checked="" type="checkbox"/> OATS 3			JUL/2005
2	EMI TEST RECEIVER	20Hz ~ 26.5GHz	ROHDE & SCHWARZ	ESMI 845442/006	FEB/2006
3	PRE-AMPLIFIER	9KHz ~ 3000MHz	ADVANTEST	BB525C 90081001	OCT/2005
4	ANTENNA (BI-LOG)	25MHz ~ 2GHz	SCHAFFNER	CBL6112B S/N : 2614	JUN/2006
5	Attenuation	50Ω/6dB	JYE BAO	FAT-N (M-F) 001	JUL/2005
6	Ferrite Clamp	30 ~ 1000MHz	ADT	FC18 910030	DEC/2005
7	Ferrite Clamp	30 ~ 1000MHz	HomeTek	HFC 001	DEC/2005
8	Cable	10m	SUHNER	RG214/U OS3-003	DEC/2005
9	Cable	14m	BELDEN	9913 OS3-001	DEC/2005
10	EMI 32 (software)	N/A	AUDIX	19991013-0923	N/A

Note : Items 1 ~ 9 were calibrated within period of 1 year.

2 TEST PROCEDURE

- 2.1 The EUT was test according to **AS/NZS CISPR 22**.
- 2.2 The radiated test was performed at HomeTek Lab's Open Site III.
- 2.3 The frequency range from 30 MHz to 1 GHz, the measurement were made at 10 meters, with a BI-log antenna.

3 TEST SETUP

3.1 TEST SETUP OF OPEN SITE.

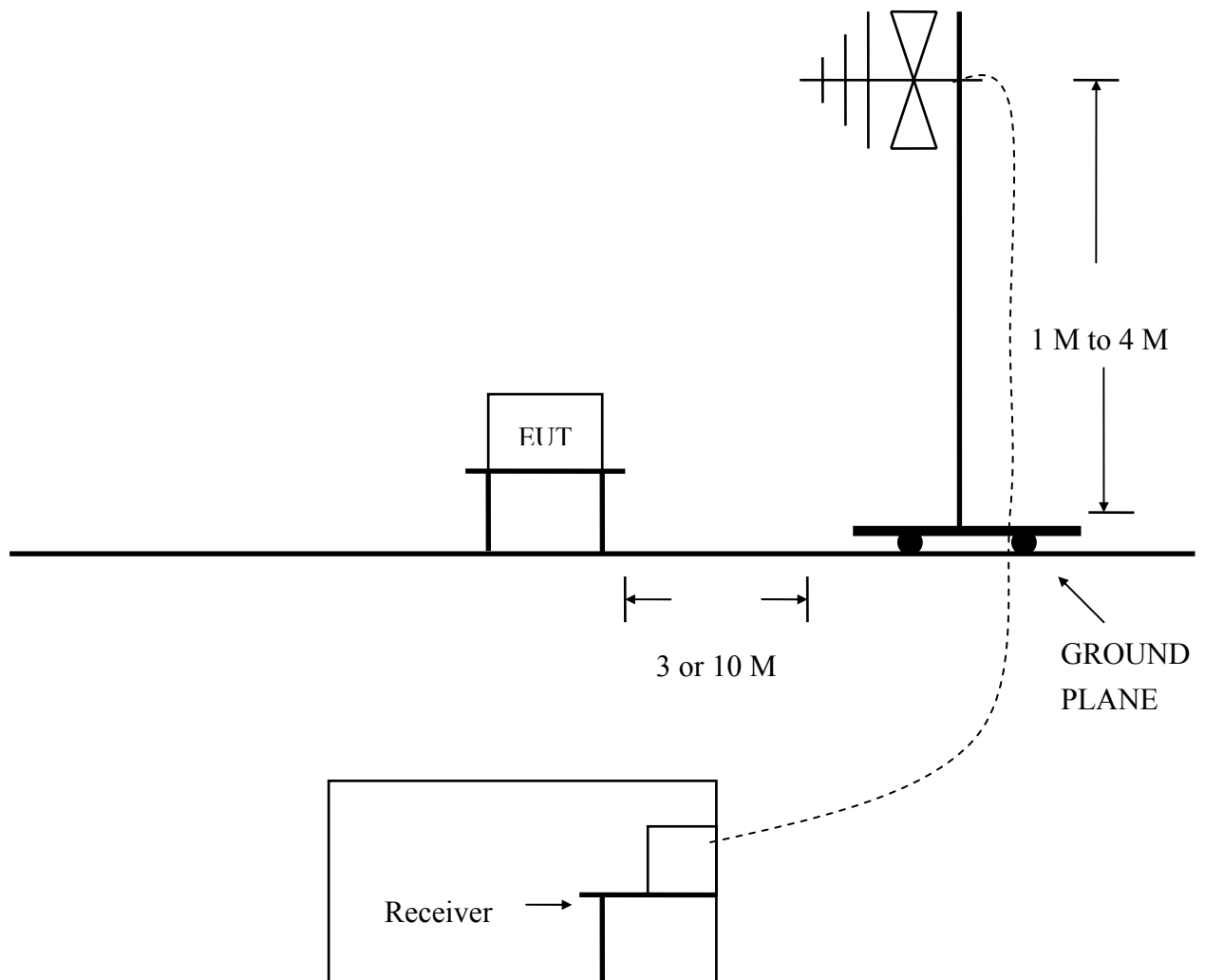

3.2 TEST SETUP OF EUT

ELECTRICAL AND ELECTRONIC EQUIPMENT IN THE RANGE OF 9kHz TO 40 GHz AS
NZS CISPR 22

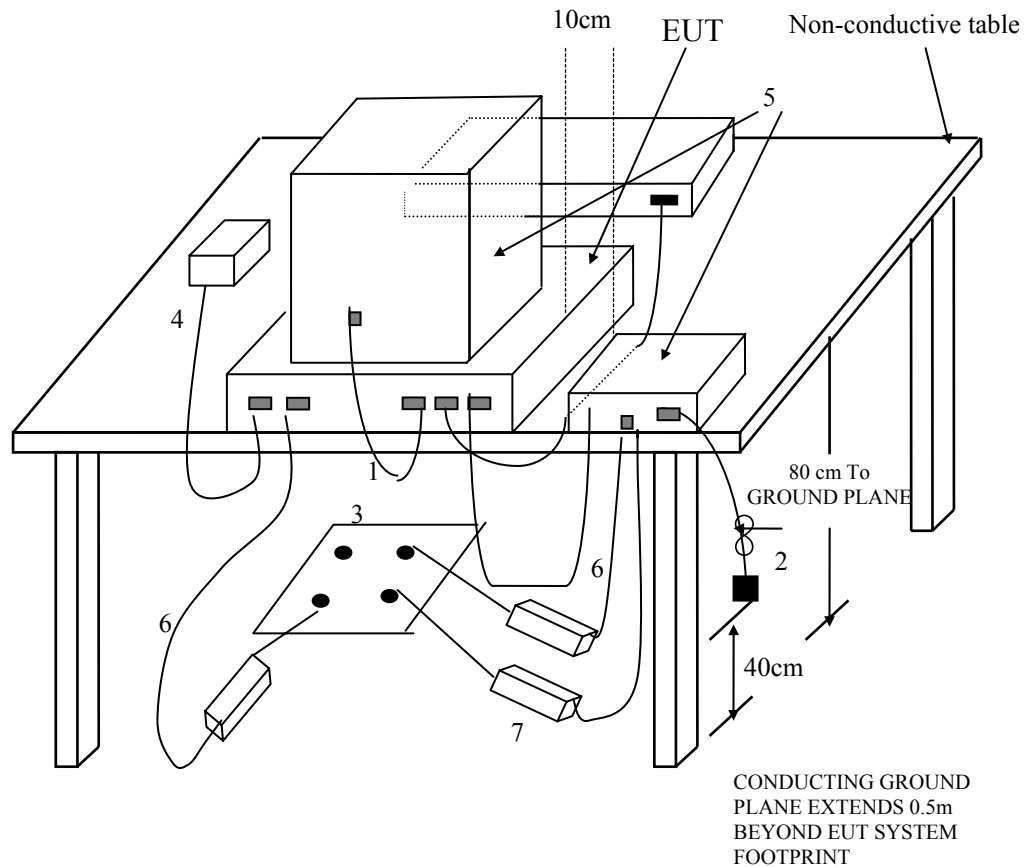

(Details for setup configuration, please refer to appendix A.)

LEGEND:

1. If cables, which hang closer than 40 cm to the horizontal metal ground plane cannot be shortened to the appropriate length, the excess shall be folded back and forth forming a bundle 30 cm to 40 cm long.
2. The end of I/O signal cables which are not connected to a peripheral may be terminated, if required for proper operation using correct terminating impedance.
3. Mains junction box(es) shall be flush with, and bonded directly to, the metal ground plane.
NOTE if used, the AMN shall be installed under the horizontal metal ground plane.
4. Cables of hand-operated devices such as keyboards, mice, etc. shall be placed as for normal usage.
5. Peripherals shall be placed at a distance of 10 cm from each other and from the controller, except for the monitor which, if for an acceptable installation practice, shall be placed directly on top of the controller.
6. Mains cables, telephone lines or other connections to auxiliary equipment located outside the test area shall drape to the floor, be fitted with ferrite clamps or ferrite tubes placed on the floor at the point where the cable reaches the floor and then routed to the place where they leave the turntable. No extension cords shall be used to mains receptacle.
7. Ferrite clamps or ferrite tubes with similar characteristics (as defined in 10.4). No more than one cable per clamp.

Test Configuration Tabletop Equipment Radiated Emission

4 CONFIGURATION OF THE EUT
Same as “Conducted Power Line test”, section 5

5 EUT OPERATING CONDITION

5.1 Same as “Conducted Power Line test”, section 5

5.2 The radiated emission in the frequency range from 30 MHz - 1000 MHz was test in a horizontal and vertical polarization at HomeTek Lab’s open site III.

5.3 The photos of radiated test configuration, please refer to appendix A.

6 LIMIT OF RADIATED EMISSION CLASS B

AS/NZS CISPR 22

Frequency (MHz)	Measurement Distance	Limit (dBuV/m)
30 - 230	10 (M)	30
230 - 1000	10 (M)	37

6.1 The tighter limit shall apply at the edge between two frequency bands.

6.2 Measurement distance in meters between the measuring instrument antenna and the closed point of any part of the EUT or peripherals.

7 RESULT OF RADIATED EMISSION TEST

7.1 The frequency range from 30 MHz to 1 GHz was investigated.

7.2 All readings below or equal 1 GHz are quasi-peak or peak values with resolution bandwidth of 120 KHz.

7.3 The measurements were made at 10 meters of HomeTek Lab’s open site III.

7.4 Temperature : 32 °C, Humidity : 47 % RH.

7.5 Uncertainty in radiated emission measurement : $\pm 4.18\text{dB}$.

7.6 The radiated emission result were gained by the following method :

Level = Reading Level + Probe Factor (Antenna Factor) + Cable Loss – Preamp Factor

Over Limit = Level – Limit Line

7.7 Result : **PASSED**



8 RADIATED EMISSION TEST DATA (PAGE 1)



HomeTek Technology Inc.

No 67-9, Shi-Men Rd;, Tu-Chen City, Taipei County, Taiwan R.O.C. Tel:02-22608375 Fax:02-22748013

Data#: 5 File#: 5F019.EMI

Date: 2006-06-22 Time: 09:00:44

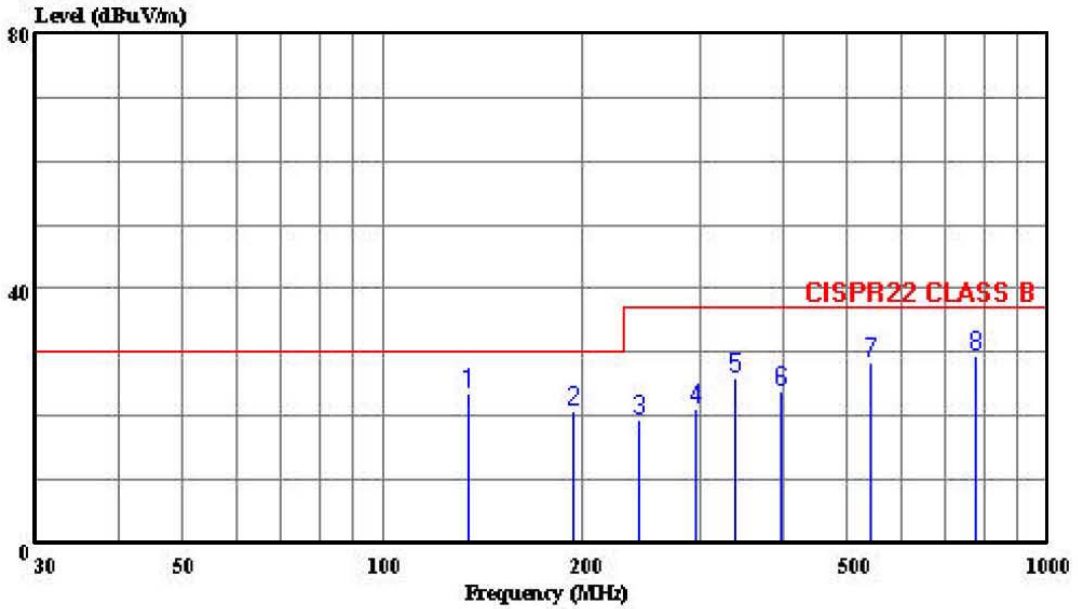

Trace:

Ref Trace:

Condition: CISPR22 CLASS B 10m CHASE 2614 060506 HORIZONTAL
eut : Video Distribution Amplifier
power: 240V/50Hz
memo : CD408A

Page: 1

Peak	Freq MHz	Level dBuV/m	Limit dBuV/m	Over Limit dB	ReadAntenna Level dBuV	Cable Factor dB/m	Preamp Loss dB	Remark
1	134.340	23.49	30.00	-6.51	36.18	11.45	1.58	25.72 Peak
2	192.913	20.83	30.00	-9.17	35.54	8.98	1.94	25.64 Peak
3	242.740	19.33	37.00	-17.67	31.10	11.66	2.14	25.58 Peak
4	296.000	20.97	37.00	-16.03	31.10	13.04	2.35	25.52 Peak
5	337.440	25.93	37.00	-11.07	34.73	14.09	2.56	25.44 Peak
6	397.940	23.89	37.00	-13.11	30.79	15.55	2.88	25.33 Peak
7	539.447	28.33	37.00	-8.67	31.22	18.44	3.47	24.80 Peak
8	779.333	29.44	37.00	-7.56	29.32	19.70	4.26	23.85 Peak



9 RADIATED EMISSION TEST DATA (PAGE 2)



HomeTek Technology Inc.

No 67-9, Shi-Men Rd., Tu-Chen City,
 Taipei County, Taiwan R.O.C.
 Tel: 02-22608375
 Fax: 02-22748013

Data#: 6 File#: 5F019.EMI

Date: 2006-06-22 Time: 09:47:20

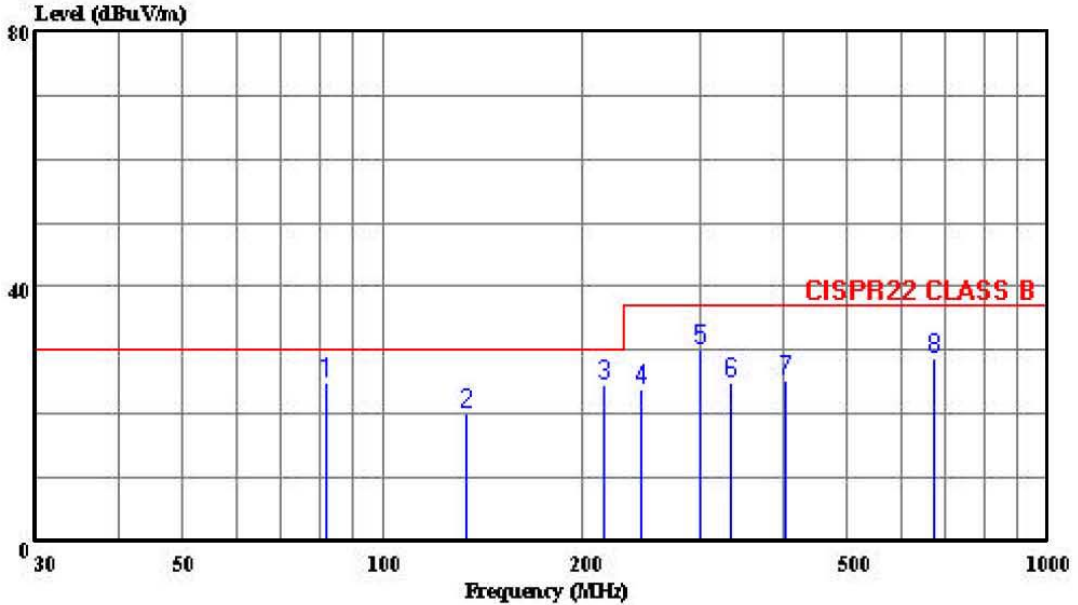

Trace:

Ref Trace:

Condition: CISPR22 CLASS B 10m CHASE 2614 060506 VERTICAL
 eut : Video Distribution Amplifier
 power: 240V/50Hz
 memo : CD408A

Page: 1

	Limit	Over	ReadAntenna	Cable	Preamp			
Freq	Level	Line	Level	Loss	Factor	Remark		
MHz	dBuV/m	dBuV/m	dB	dB	dB			
1	82.027	24.85	30.00	-5.15	41.89	7.57	1.22	25.83 Peak
2	133.500	20.08	30.00	-9.92	32.77	11.46	1.58	25.72 Peak
3	215.553	24.61	30.00	-5.39	39.08	9.10	2.04	25.61 Peak
4	244.007	23.77	37.00	-13.23	35.37	11.82	2.15	25.58 Peak
5	300.000	30.18	37.00	-6.82	40.21	13.13	2.37	25.52 Peak
6	333.527	24.94	37.00	-12.06	33.84	14.01	2.54	25.45 Peak
7	404.460	25.42	37.00	-11.58	32.14	15.68	2.91	25.31 Peak
8	674.887	28.89	37.00	-8.11	30.03	18.90	4.07	24.11 Peak



HomeTek Technology Inc.

Appendix A

PHOTOS OF TEST CONFIGURATION

PHOTO OF CONDUCTED POWER LINE TEST

Model : CD408A

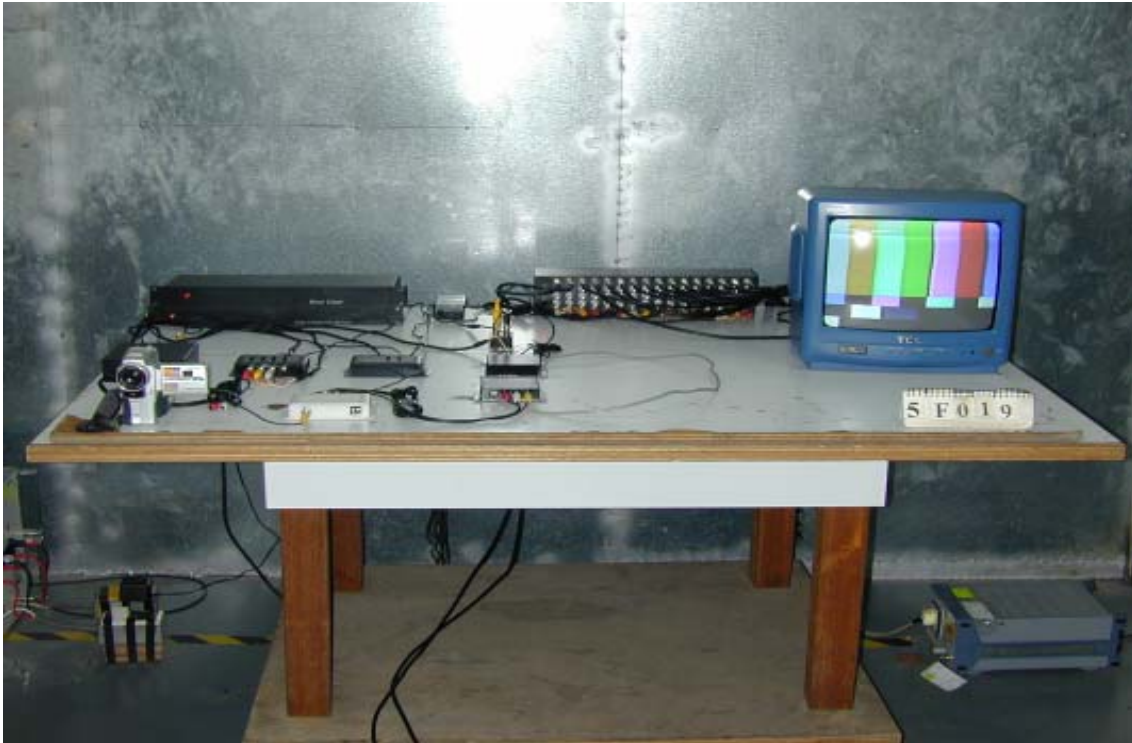

Front View



Rear View

PHOTO OF RADIATED EMISSION TEST

Model : CD408A



Front View



Rear View



HomeTek Technology Inc.

Appendix B

PHOTOS OF EUT

PHOTO OF EUT

Model : CD408A



Full View of EUT

PHOTO OF EUT

Model : CD408A

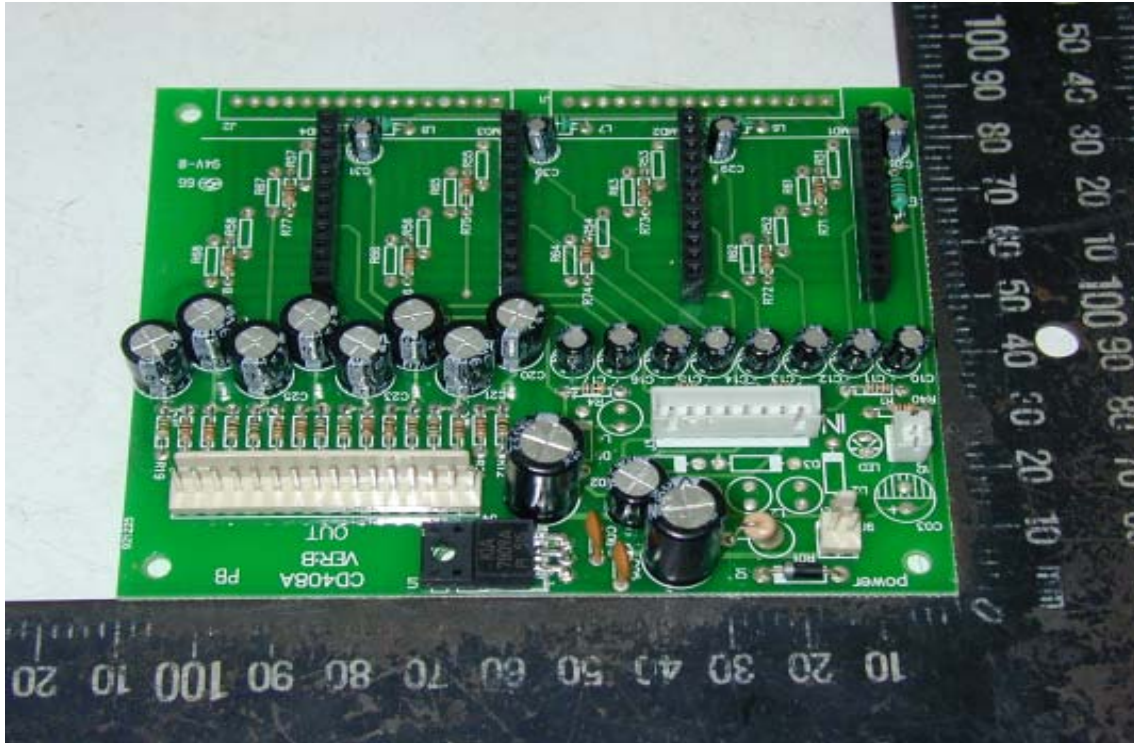

Component Side of Main Board 1

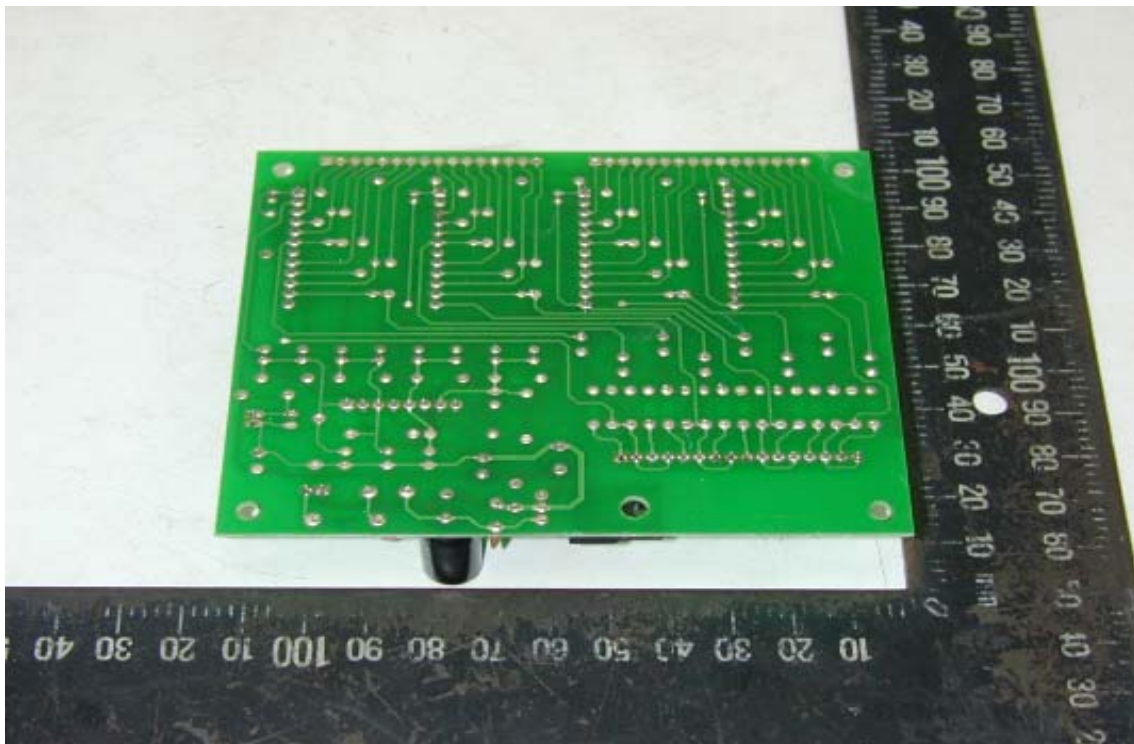

Solder Side of Main Board 1

PHOTO OF EUT

Model : CD408A

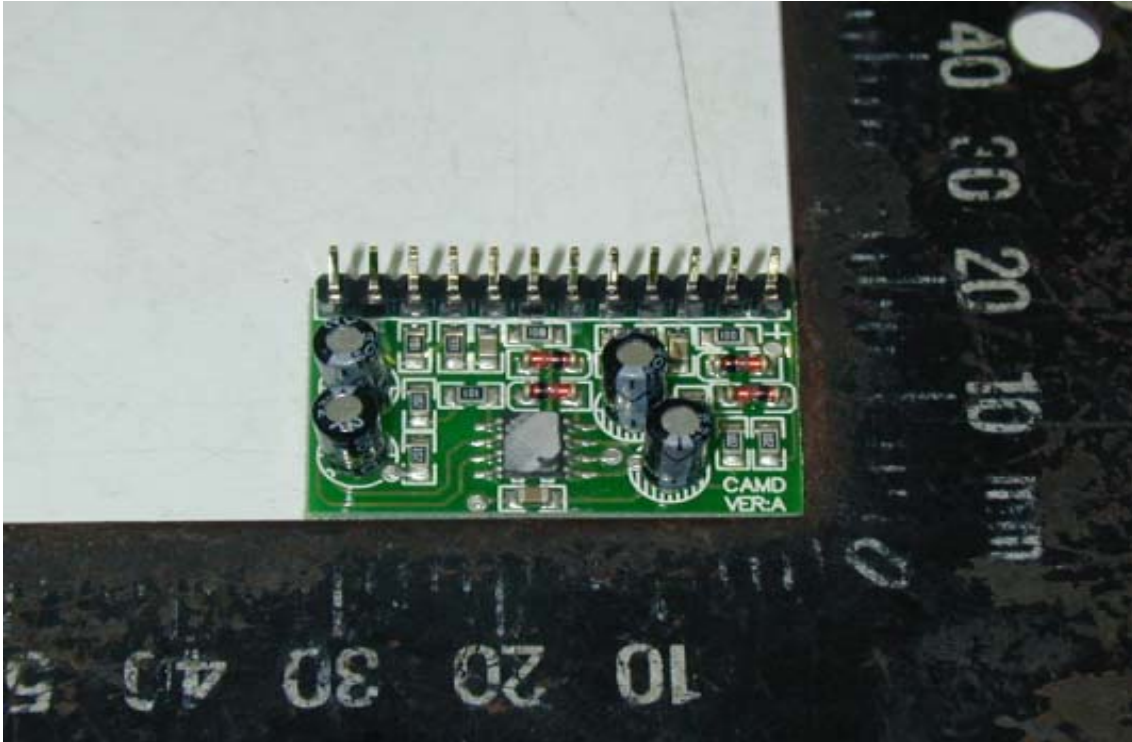

Component Side of Main Board 2

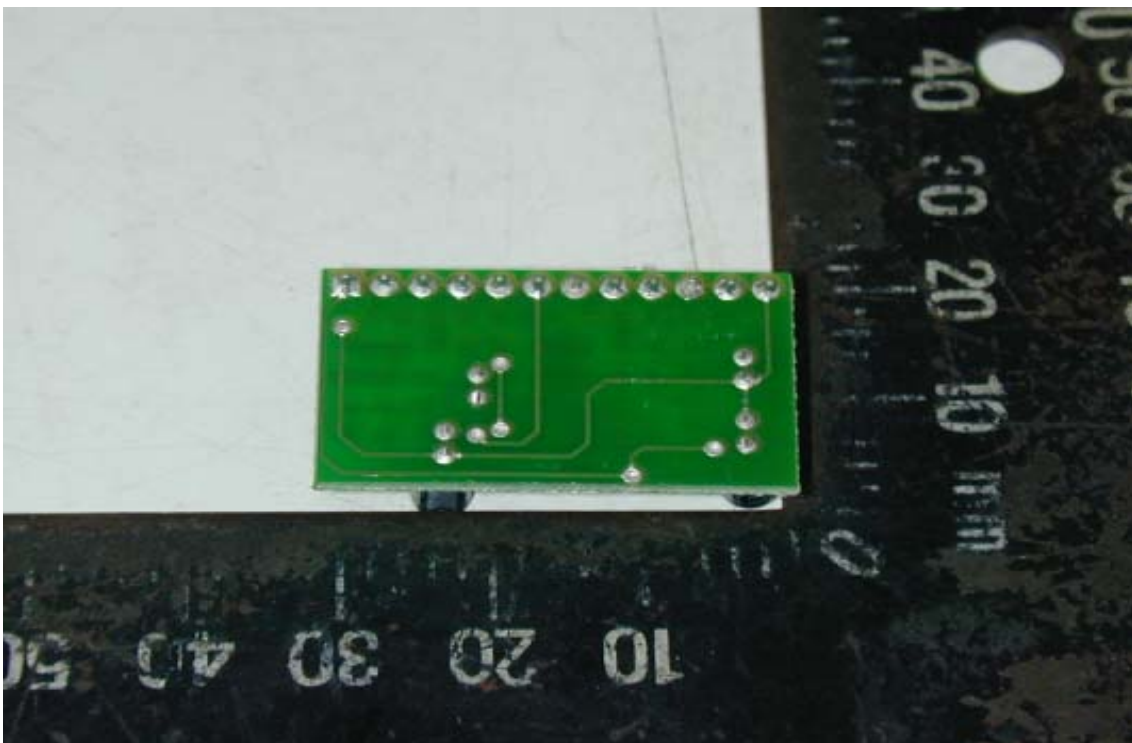

Solder Side of Main Board 2

PHOTO OF EUT

Model : CD408A

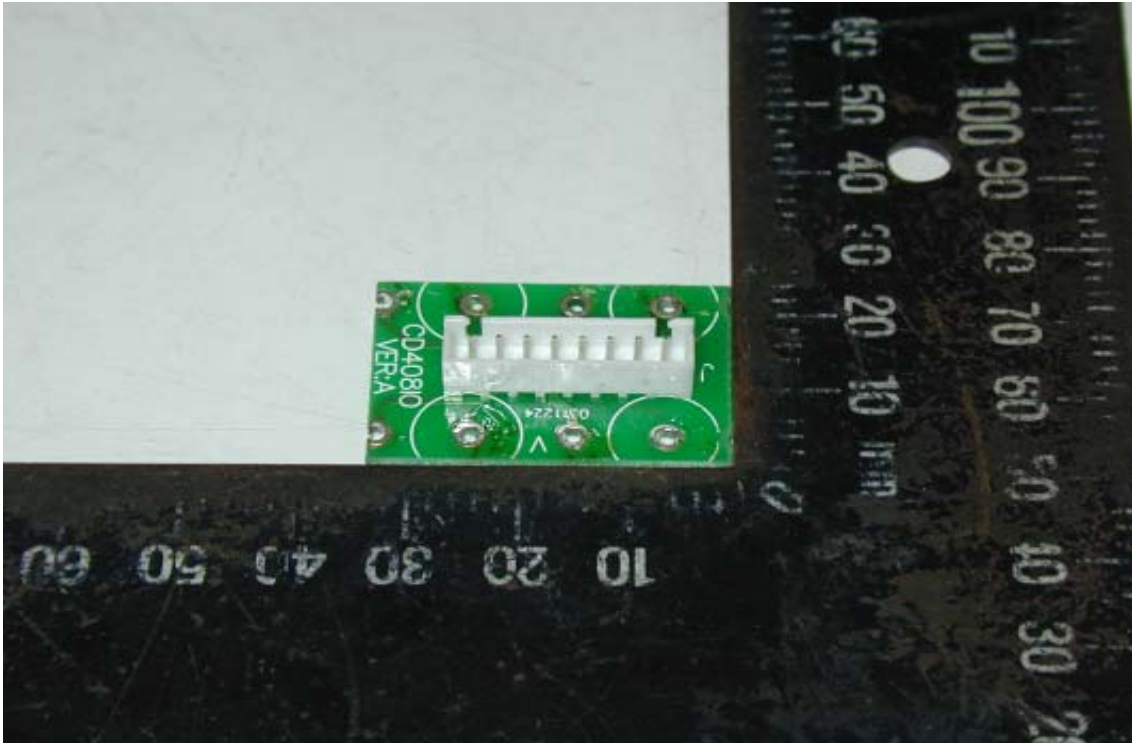

Component Side of Main Board 3

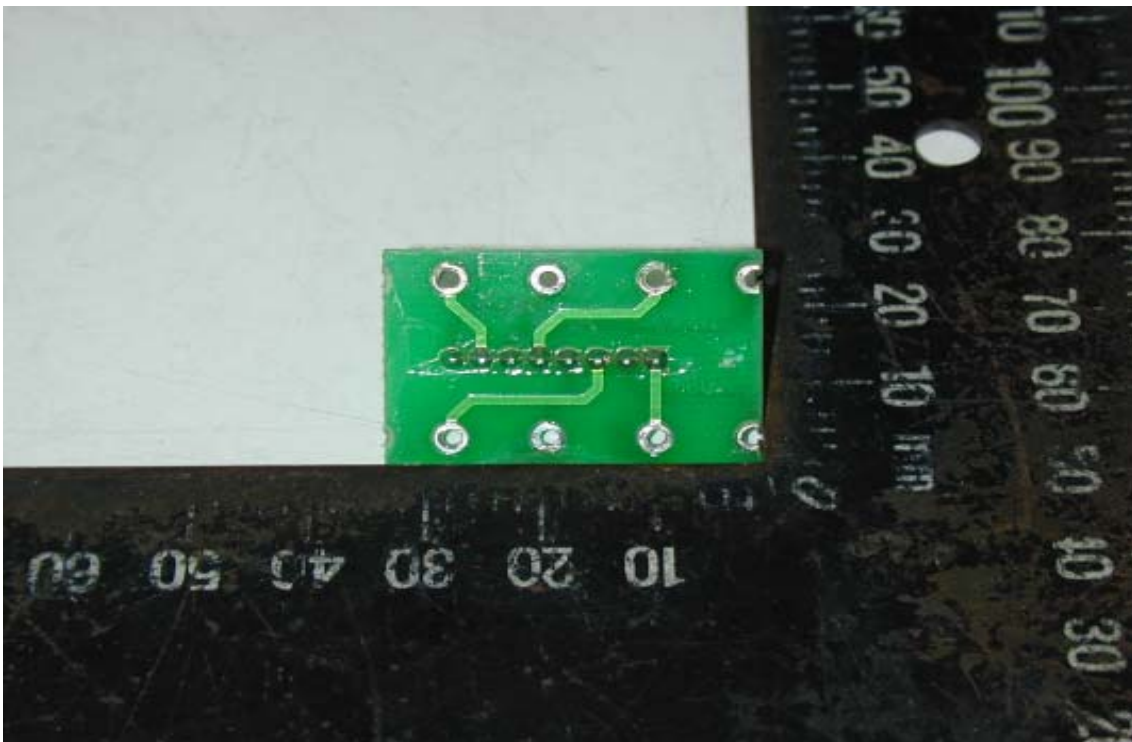

Solder Side of Main Board 3

PHOTO OF EUT

Model : CD408A

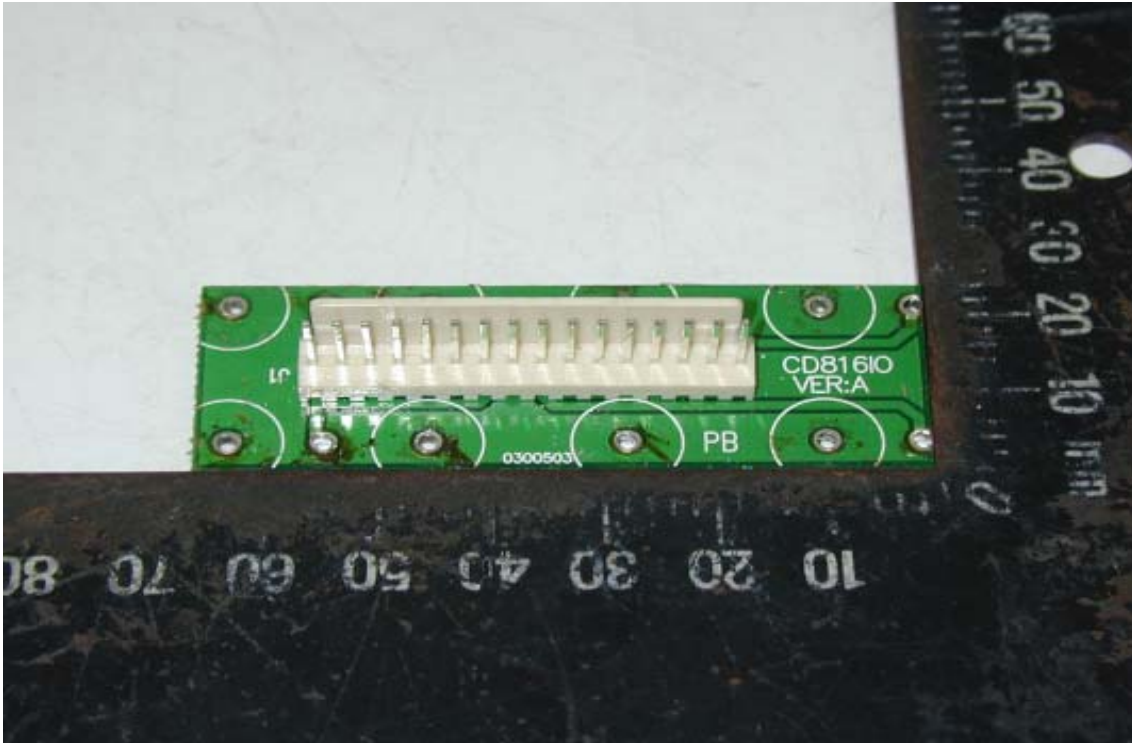

Component Side of Main Board 4

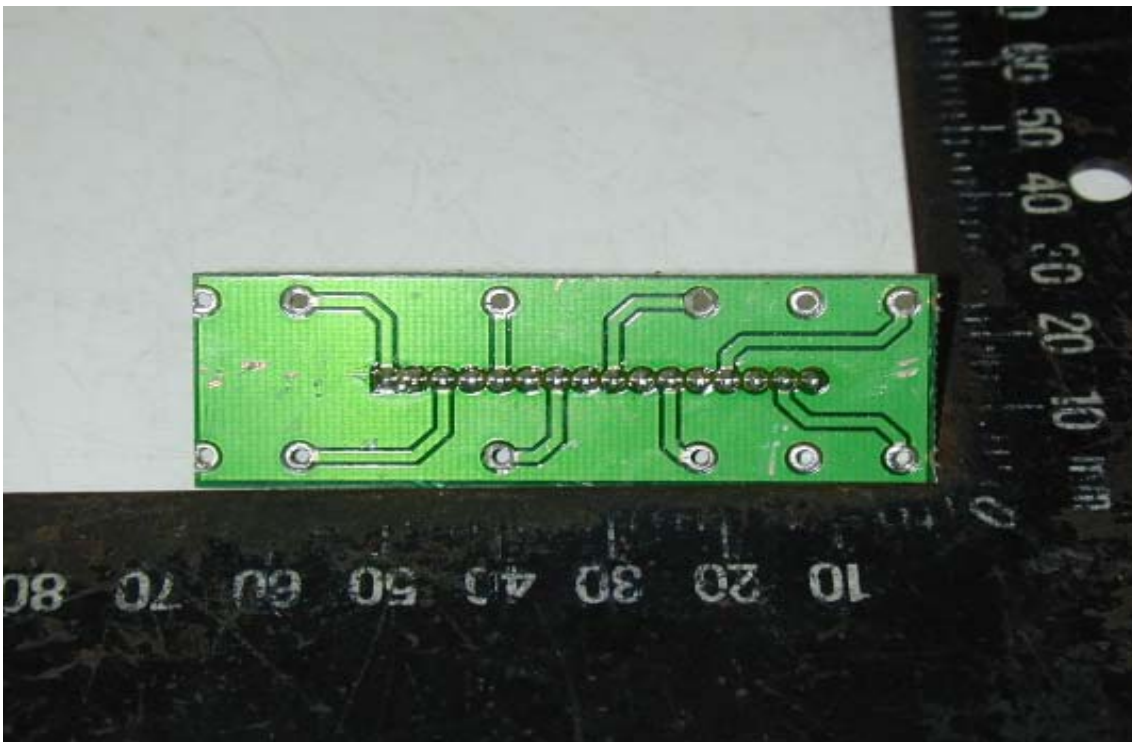

Solder Side of Main Board 4

Declaration of Conformity

Responsible Party Name :

Address :

Phone No :

Fax No :

Declares under our sole responsibility that the product

Product Name : Video Distribution Amplifier

Model No. : CD40XXX

to which this declaration relates is in conformity with the following standards or other normative documents

AS/NZS CISPR 22 (2004) : Electromagnetic Interference
– Limits and Methods of Measurement of Information Technology Equipment

Representative Person's Name : _____

Signature : _____

Date : _____

United States Department of Commerce
National Institute of Standards and Technology



Certificate of Accreditation to ISO/IEC 17025:1999

NVLAP LAB CODE: 200331-0

HomeTek Technology Inc.

Taipei Shien 236
TAIWAN

*is recognized by the National Voluntary Laboratory Accreditation Program for conformance with criteria set forth in
NIST Handbook 150:2001 and all requirements of ISO/IEC Guide 17025:1999.
Accreditation is granted for specific services, listed on the Scope of Accreditation, for:*

ELECTROMAGNETIC COMPATIBILITY AND TELECOMMUNICATIONS

2005-10-01 through 2006-09-30

Effective dates



For the National Institute of Standards and Technology

A handwritten signature in black ink, appearing to read "John P. Ward".



SCOPE OF ACCREDITATION TO ISO/IEC 17025:1999

HomeTek Technology Inc.
P.O Box: 13-131, Pan-Chiao City
No. 67-9 Shir Men Rd., Tu Chen City
Taipei Shien 236
TAIWAN
Mr. Grant Huang
Phone: 886-2-22608375 Fax: 886-2-22748013
E-Mail: hometek@ms15.hinet.net

**ELECTROMAGNETIC COMPATIBILITY
AND TELECOMMUNICATIONS**

NVLAP LAB CODE 200331-0

NVLAP Code Designation / Description

Emissions Test Methods:

- 12/CIS14a EN 55014-1 (1993), A1 (1997), A2 (1999):
- 12/CIS14a2 BS EN 55014-1 (2001) with A1 and A2: Electromagnetic compatibility - Requirements for household appliances, electric tools and similar apparatus - Part 1: Emission
- 12/CIS14b1 AS/NZS CISPR 14-1 (2003): Electromagnetic Compatibility - Requirements for household appliances, electric tools and similar apparatus - Part 1: Emission
- 12/CIS14c CNS 13783-1: Electromagnetic Compatibility Requirements for household appliances, electric tools and similar apparatus - Part 1: Emissions
- 12/CIS14d IEC/CISPR 14-1 (2001) and A1 (2001): Electromagnetic Compatibility - Requirements for household appliances, electric tools and similar apparatus - Part 1: Emissions
- 12/CIS14x IEC/CISPR 14-1, Ed. 4 (2003): Electromagnetic Compatibility - Requirements for household appliances, electric tools and similar apparatus - Part 1: Emission
- 12/CIS22 IEC/CISPR 22 (1997) & EN 55022 (1998) + A1(2000): Limits and methods of measurement of radio disturbance characteristics of information technology equipment
- 12/CIS22a IEC/CISPR 22 (1993) and EN 55022 (1994): Limits and methods of measurement of radio disturbance characteristics of information technology equipment, Amendment 1 (1995) and Amendment 2 (1996)

2005-10-01 through 2006-09-30

Effective dates

For the National Institute of Standards and Technology



**National Voluntary
Laboratory Accreditation Program**



**ELECTROMAGNETIC COMPATIBILITY
AND TELECOMMUNICATIONS**

NVLAP LAB CODE 200331-0

<i>NVLAP Code</i>	<i>Designation / Description</i>
12/CIS22b	CNS 13438 (1997): Limits and Methods of Measurement of Radio Interference Characteristics of Information Technology Equipment
12/CIS22c	IEC/CISPR 22, Fourth Edition (2003-04) & EN 55022 (1998): Information technology equipment - Radio disturbance characteristics - Limits and methods of measurement
12/FCC15b	ANSI C63.4 (2003) with FCC Method 47 CFR Part 15, Subpart B: Unintentional Radiators
12/T51a	AS/NZS CISPR 22 (2004): Information technology equipment - Radio disturbance characteristics - Limits and methods of measurement
12/VCCIa	VCCI: Agreement of Voluntary Control Council for Interference by Information Technology Equipment - Technical Requirements: V-3/2004.04

2005-10-01 through 2006-09-30

Effective dates

For the National Institute of Standards and Technology