



HomeTek Technology Inc.

ADDRESS: No. 67-9, Shir Men Road, Tu Cheng City,
Taipei Hsien, Taiwan,
PHONE : 886-2-22608375 FAX : 886-2-22748013
E - mail : hometek@ms15.hinet.net



EMI TEST REPORT FOR

APPLICANT : SMART CABLING & TRANSMISSION CORP.
ADDRESS : 10F, No. 493, Chung-Cheng Rd.,
Hsin Tien City, Taipei 231, Taiwan, R. O. C.
EUT : Component video & digital audio CAT5 Extender
MODEL NO. : CV0XXX, YE0XXX

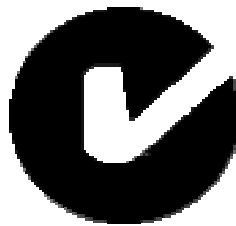

MEASUREMENT PROCEDURE USED

AS/NZS CISPR 22: 2004 Information technology equipment – Radio disturbance characteristics – Limits and methods of measurement

PREPARED BY :
HomeTek Technology Inc.
No. 67-9, Shir Men Road, Tu Cheng City,
Taipei Hsien. Taiwan
Report # : AS6E028



TABLE OF CONTENTS..... 2

CERTIFICATE 3

GENERAL INFORMATION..... 4

MODIFICATION LIST..... 5

CONDUCTED POWER LINE TEST 6

 1 TEST PROCEDURE..... 6

 2 RESULT OF CONDUCTED EMISSION TEST..... 6

RADIATED EMISSION TEST..... 7

 1 TEST INSTRUMENTS & FACILITIES..... 7

 2 TEST PROCEDURE..... 8

 3 TEST SETUP 8

 4 CONFIGURATION OF THE EUT 10

 5 EUT OPERATING CONDITION..... 14

 6 LIMIT OF RADIATED EMISSION CLASS B 15

 7 RESULT OF RADIATED EMISSION TEST..... 15

 8 RADIATED EMISSION TEST DATA (PAGE 1)..... 16

 9 RADIATED EMISSION TEST DATA (PAGE 2)..... 17

APPENDIX A

PHOTOS OF TEST CONFIGURATION

APPENDIX B

PHOTOS OF EUT

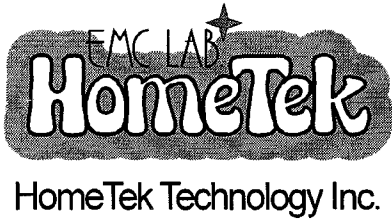

ADDRESS: No. 67-9, Shir Men Road, Tu Cheng City,
Taipei Hsien, Taiwan
PHONE : 886-2-22608375 FAX : 886-2-22748013
E - mail : hometek@ms15.hinet.net

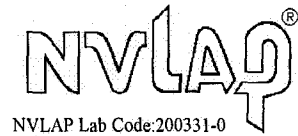

CERTIFICATE

APPLICANT : SMART CABLING & TRANSMISSION CORP.
ADDRESS : 10F, No. 493, Chung-Cheng Rd.,
Hsin Tien City, Taipei 231, Taiwan, R. O. C.
Receipt Date : 05/15/2007 Final Test Date: 05/29/2007
EUT : Component video & digital audio CAT5 Extender
MODEL NO. : CV0XXX, YE0XXX

MEASUREMENT PROCEDURE USED :

AS/NZS CISPR 22: 2004 Information technology equipment – Radio
disturbance characteristics – Limits and methods of measurement

- THE MAXIMUM EMISSION LEVELS WERE COMPARED TO THE CISPR 22 CLASS B LIMITS BOTH RADIATED AND CONDUCTED EMISSION.
- THE ABOVE DEVICE WAS TESTED BY HOMETEK TECHNOLOGY INC. TO SHOWS THE MAXIMUM EMISSION LEVEL FROM THE DEVICE.
- THIS TEST RESULTS OF THIS REPORT APPLIES TO ABOVE TESTED SAMPLE ONLY.
- THIS TEST REPORT SHALL NOT BE REPRODUCE IN PART WITHOUT WRITTEN APPROVAL OF HOMETEK TECHNOLOGY INC.
- THE REPORT MUST NOT BE USED BY THE CLIENT TO CLAIM PRODUCT ENDORSEMENT BY NVLAP, NIST OR ANY AGENCY OF THE U. S. GOVERNMENT.
- THE TEST RESULTS ARE TRACEABLE TO THE NATIONAL OR INTERNATIONAL STANDARD.

APPROVED BY :  5/31/2007

ALAIN LIN / Supervisor

GENERAL INFORMATION

- 1 APPLICANT : SMART CABLING & TRANSMISSION CORP.
- 2 ADDRESS : 10F, No. 493, Chung-Cheng Rd.,
Hsin Tien City, Taipei 231, Taiwan, R. O. C.
- 3 MANUFACTURER : SMART CABLING & TRANSMISSION CORP.
- 4 ADDRESS : 10F, No. 493, Chung-Cheng Rd.,
Hsin Tien City, Taipei 231, Taiwan, R. O. C.
- 5 DESCRIPTION OF EUT :
- EUT : Component video & digital audio CAT5 Extender
- Model Number : CV0XXX, YE0XXX
- Serial # : N/A

5.1 The difference between series of models CV0XXX and YE0XXX are different in OEM manufacture and other as shown below:

- (1) The first and second “X” represents different system input.
- (2) The third “X” represent different accessory.

The PCB layout is similar. The worst case of EMI test data were shown in this test report.

- 6 FEATURES OF EUT :

Please refer to user manual or product specification.



MODIFICATION LIST

THE FOLLOWING ACCESSORIES WERE ADDED TO THE EUT DURING TESTING :

NO MODIFICATION BY HOMETEK TECHNOLOGY INC.

CONDUCTED POWER LINE TEST

1 TEST PROCEDURE

According to **AS/NZS CISPR 22**.

2 RESULT OF CONDUCTED EMISSION TEST

N/A (Conducted Power Line Test is not applicable to this EUT (Model : CV01A)).

RADIATED EMISSION TEST

1 TEST INSTRUMENTS & FACILITIES

The following test Instruments was used during the radiated emission test :

Item	Instruments /facilities	Specification	Manufacturer	Model # / S/N#	Date of Cal.
1	OPEN AREA TEST SITE	<input checked="" type="checkbox"/> OATS 3			JUL/2006
2	EMI TEST RECEIVER	20Hz ~ 26.5GHz	ROHDE & SCHWARZ	ESMI 845442/006	FEB/2007
3	PRE-AMPLIFIER	9KHz ~ 3000MHz	ADVANTEST	BB525C 90081001	OCT/2006
4	ANTENNA (BI-LOG)	25MHz ~ 2GHz	SCHAFFNER	CBL6112B S/N : 2614	JUN/2006
5	Attenuation	50Ω/6dB	JYE BAO	FAT-N (M-F) 001	JUL/2006
6	Ferrite Clamp	30 ~ 1000MHz	ADT	FC18 910030	DEC/2006
7	Ferrite Clamp	30 ~ 1000MHz	HomeTek	HFC 001	DEC/2006
8	Cable	10m	SUHNER	RG214/U OS3-003	DEC/2006
9	Cable	14m	BELDEN	9913 OS3-001	DEC/2006
10	EMI 32 (software)	N/A	AUDIX	19991013-0923	N/A

Note : Items 1 ~ 9 were calibrated within period of 1 year.

2 TEST PROCEDURE

- 2.1 The EUT was test according to **AS/NZS CISPR 22**.
- 2.2 The radiated test was performed at HomeTek Lab's Open Site III.
- 2.3 The frequency range from 30 MHz to 1 GHz, the measurement were made at 10 meters, with a BI-log antenna.

3 TEST SETUP

3.1 TEST SETUP OF OPEN SITE.

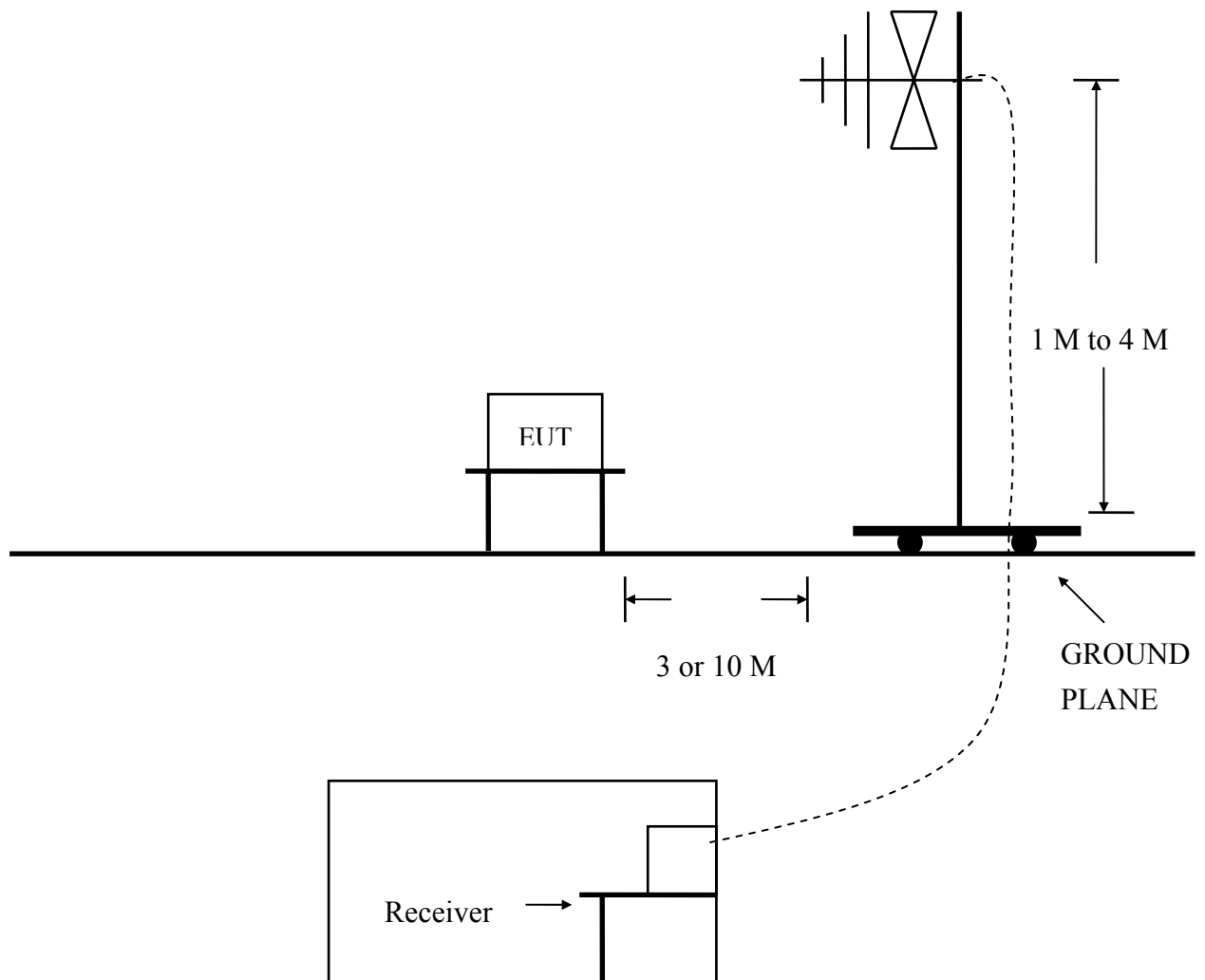

3.2 TEST SETUP OF EUT

ELECTRICAL AND ELECTRONIC EQUIPMENT IN THE RANGE OF 9kHz TO 40 GHz AS
NZS CISPR 22

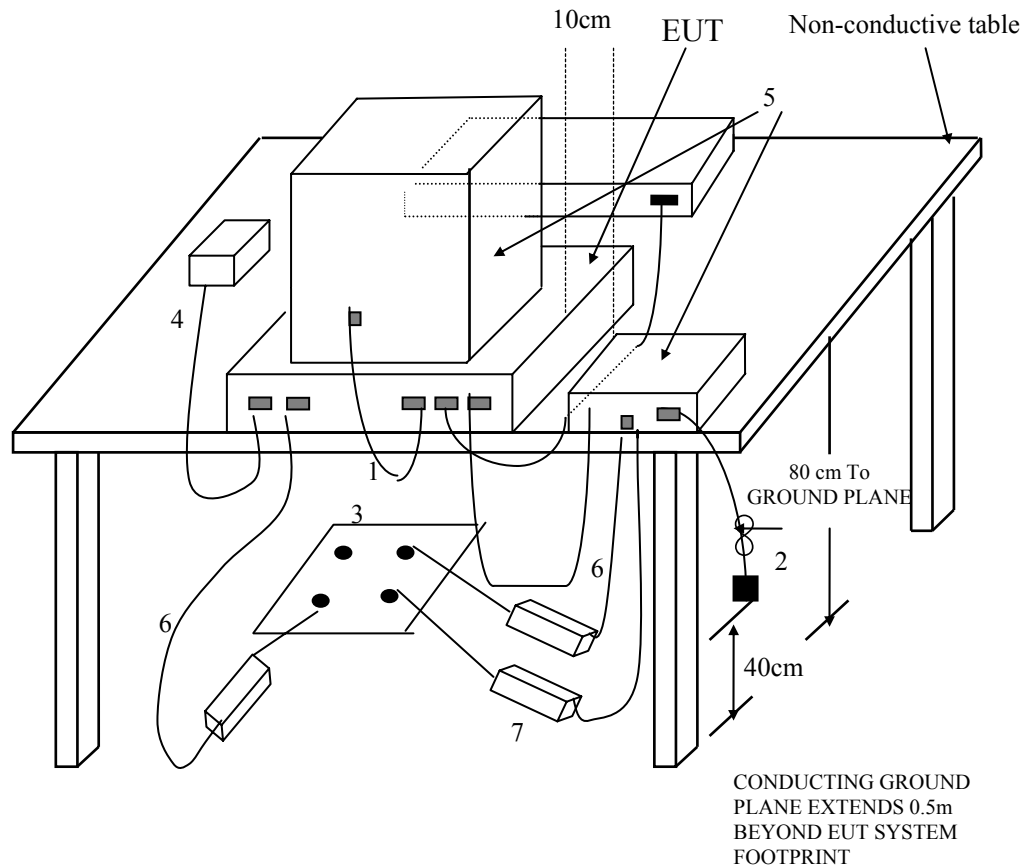

(Details for setup configuration, please refer to appendix A.)

LEGEND:

1. If cables, which hang closer than 40 cm to the horizontal metal ground plane cannot be shortened to the appropriate length, the excess shall be folded back and forth forming a bundle 30 cm to 40 cm long.
2. The end of I/O signal cables which are not connected to a peripheral may be terminated, if required for proper operation using correct terminating impedance.
3. Mains junction box(es) shall be flush with, and bonded directly to, the metal ground plane.
NOTE if used, the AMN shall be installed under the horizontal metal ground plane.
4. Cables of hand-operated devices such as keyboards, mice, etc. shall be placed as for normal usage.
5. Peripherals shall be placed at a distance of 10 cm from each other and from the controller, except for the monitor which, if for an acceptable installation practice, shall be placed directly on top of the controller.
6. Mains cables, telephone lines or other connections to auxiliary equipment located outside the test area shall drape to the floor, be fitted with ferrite clamps or ferrite tubes placed on the floor at the point where the cable reaches the floor and then routed to the place where they leave the turntable. No extension cords shall be used to mains receptacle.
7. Ferrite clamps or ferrite tubes with similar characteristics (as defined in 10.4). No more than one cable per clamp.

Test Configuration Tabletop Equipment Radiated Emission

4 CONFIGURATION OF THE EUT

The EUT was configured according to **AS/NZS CISPR 22**. All I/O ports were connected to the appropriate peripherals. All peripherals and cables are listed below (including internal device) :

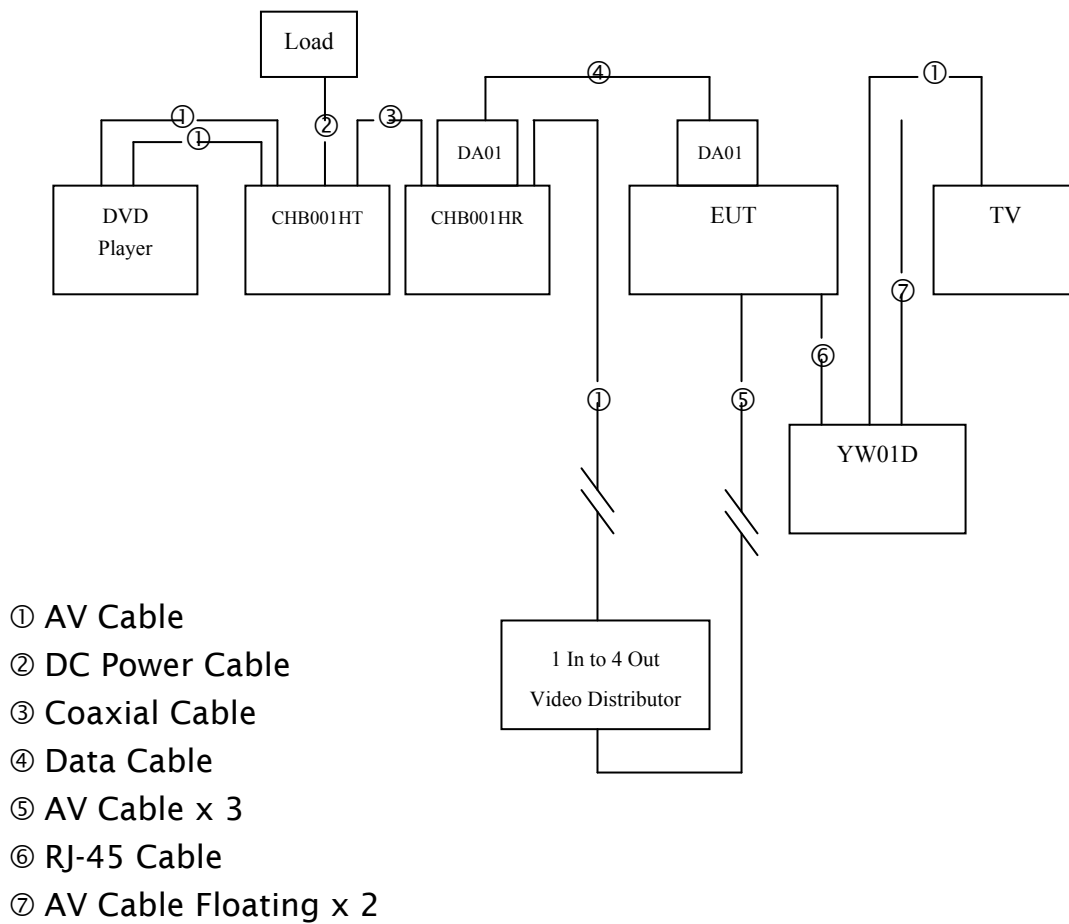

Figure 1



4.1 EUT

EUT Type : Proto Type Engineer Type Mass Production
Condition when received : Good Damage : _____
Device : Component video & digital audio CAT5 Extender
Applicant : SMART CABLING & TRANSMISSION CORP.
Manufacturer : SMART CABLING & TRANSMISSION CORP.
Model Number : CV0XXX, YE0XXX
Serial Number : N/A
FCC ID : N/A
RJ-45 Port : Plastics Type Connector
Audio In Port : Metal Type Connector
Y Port : Metal Type Connector
Pb Port : Metal Type Connector
Pr Port : Metal Type Connector
Power Cord : N/A
Power Supply Type : N/A

4.2 PERIPHERALS

Digital Audio Transceiver x 2

Manufacturer : SMART CABLING & TRANSMISSION CORP.
Model Number : DA01
Serial Number : N/A
FCC ID : N/A
Data Cable : Un-Shielded, 0.6 m
Power Cord & Adaptor : N/A



Hi Frequency Interference Blocker

Manufacturer : SMART CABLING & TRANSMISSION CORP.
Model Number : CHB001HT
Serial Number : N/A
FCC ID : N/A
Data Cable 1 x 2 : Un-Shielded, 1.6 m, Connected to the AV port
Data Cable 2 : Shielded, 1.8 m, Connected to the Coaxial port
Power Cord : Un-Shielded, 1.8 m

Hi Frequency Interference Blocker

Manufacturer : SMART CABLING & TRANSMISSION CORP.
Model Number : CHB001HR
Serial Number : N/A
FCC ID : N/A
Data Cable 1 : Un-Shielded, 10 m, Connected to the AV port
Data Cable 2 : Shielded, 1.8 m, Connected to the Coaxial port
Power Cord : Un-Shielded, 1.8 m

Wall Plate Component Video & Digital Audio CAT5 Extender

Manufacturer : SMART CABLING & TRANSMISSION CORP.
Model Number : YW01D
Serial Number : N/A
FCC ID : N/A
Data Cable 1 : Un-Shielded, 0.1 m, Connected to the RJ-45 port
Data Cable 2 : Un-Shielded, 1.6 m, Connected to the AV port
Power Cord : N/A



HomeTek Technology Inc.

1 In to 4 Out Video Distributor

Manufacturer : SMART CABLING & TRANSMISSION CORP.
Model Number : 15-VD14
Serial Number : N/A
FCC ID : N/A
Data Cable x 4 : Un-Shielded, 0.6 m, Connected to the AV port
Power Cord & Adaptor : Un-Shielded, 1.8 m

DVD Player

Manufacturer : LG
Model Number : DS8421N
Serial Number : N/A
FCC ID : N/A
Data Cable : Shielded, 1.6 m, Connected to the AV port
Power Cord & Adaptor : Un-Shielded, 1.8 m

TV

Manufacturer : TCL
Model Number : 1419A
Serial Number : 010019502035F0039
FCC ID : N/A
Data Cable : Shielded, 1.6 m, Connected to the AV port
Power Cord : Un-Shielded

Load

Manufacturer : HomeTek
Specification : 20Ω
Serial Number : N/A
FCC ID : N/A
Data Cable : N/A
Power Cord : Un-Shielded, 0.3 m

4.3 REMARK : N/A

5 EUT OPERATING CONDITION

5.1 The frequency of the EUT is none.

5.2 The radiated emission in the frequency range from 30 MHz - 1000 MHz was test in a horizontal and vertical polarization at HomeTek Lab's open site III.

5.3

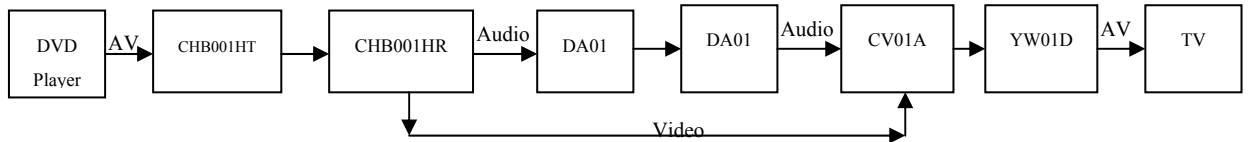

5.4 DVD Player send AV signal to CHB001HT, CHB001HR, DA01 x 2, CV01A, YW01D, and CHB001HT, CHB001HR, DA01 x 2, CV01A, YW01D change AV signal.

5.5 Then has changed AV signal send to TV display.

5.6 Measure the maximum emission noise.

5.7 The photos of radiated test configuration, please refer to appendix A.

6 LIMIT OF RADIATED EMISSION CLASS B

AS/NZS CISPR 22

Frequency (MHz)	Measurement Distance	Limit (dBuV/m)
30 - 230	10 (M)	30
230 - 1000	10 (M)	37

- 6.1 The tighter limit shall apply at the edge between two frequency bands.
- 6.2 Measurement distance in meters between the measuring instrument antenna and the closed point of any part of the EUT or peripherals.

7 RESULT OF RADIATED EMISSION TEST

- 7.1 The frequency range from 30 MHz to 1 GHz was investigated.
- 7.2 All readings below or equal 1 GHz are quasi-peak or peak values with resolution bandwidth of 120 KHz.
- 7.3 The measurements were made at 10 meters of HomeTek Lab's open site III.
- 7.4 Temperature : 26 °C, Humidity : 56 % RH.
- 7.5 Uncertainty in radiated emission measurement : $\pm 4.18\text{dB}$.
- 7.6 The radiated emission result were gained by the following method :
 Level = Reading Level + Probe Factor (Antenna Factor) + Cable Loss – Preamp Factor
 Over Limit = Level – Limit Line
- 7.7 Result : **PASSED**



8 RADIATED EMISSION TEST DATA (PAGE 1)



HomeTek Technology Inc.

No 67-9, Shi-Men Rd., Tu-Chen City,
Taipei County, Taiwan R.O.C.
Tel: 02-22608375
Fax: 02-22748013

Data#: 6 File#: 6e028.EMI

Date: 2007-05-26 Time: 14:48:24

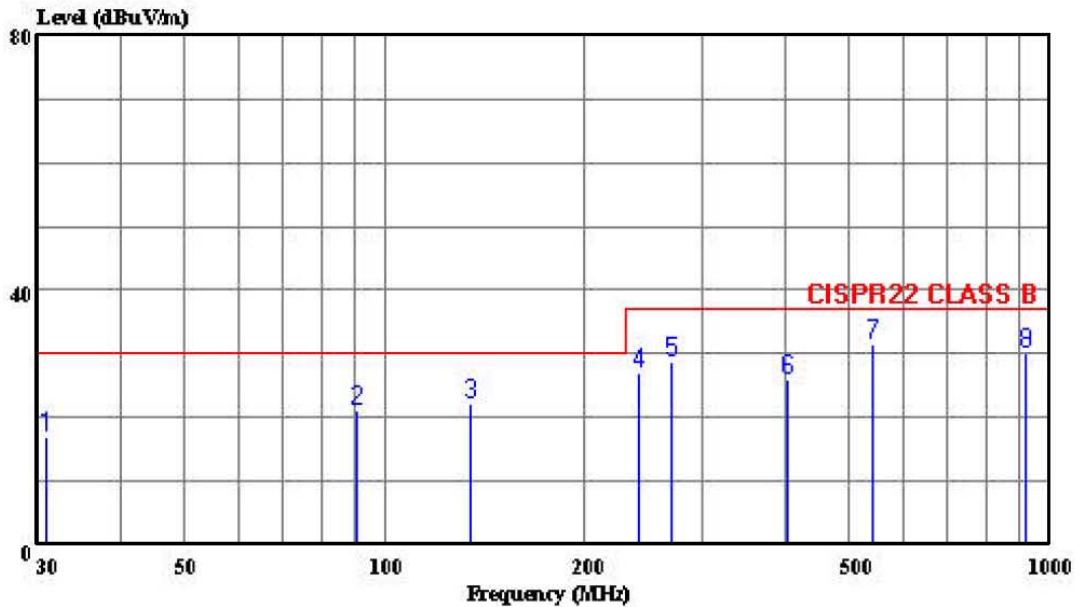

Trace:

Ref Trace:

Condition: CISPR22 CLASS B 10m CHASE 2614 060506 HORIZONTAL
 eut : Component video & digital audio CAT5 Extender
 power: 240V/50Hz
 memo : CV01A, YE01D

Page: 1

	Limit	Over	ReadAntenna	Cable	Preamp				
Freq	Level	Line	Level	Loss	Factor	Remark			
MHz	dBuV/m	dBuV/m	dB	dB	dB/m	dB	dB		
1	30.850	17.09	30.00	-12.91	24.25	18.22	0.64	26.02	Peak
2	90.750	20.97	30.00	-9.03	36.47	9.06	1.36	25.91	Peak
3	133.898	22.33	30.00	-7.67	34.97	11.46	1.73	25.83	Peak
4	241.501	27.11	37.00	-9.89	38.71	11.61	2.42	25.62	Peak
5	270.638	28.70	37.00	-8.30	39.05	12.62	2.60	25.56	Peak
6	404.483	26.07	37.00	-10.93	32.22	15.68	3.37	25.20	Peak
7	541.443	31.39	37.00	-5.61	32.79	18.49	4.78	24.68	Peak
8	920.290	30.21	37.00	-6.79	27.96	20.51	5.13	23.39	Peak
9	920.290	30.21	37.00	-6.79	27.96	20.51	5.13	23.39	Peak



9 RADIATED EMISSION TEST DATA (PAGE 2)



HomeTek Technology Inc.

No 67-9, Shi-Men Rd., Tu-Chen City,
Taipei County, Taiwan R.O.C.
Tel: 02-22608375
Fax: 02-22748013

Data#: 5 File#: 6e028.EMI

Date: 2007-05-26 Time: 13:56:38

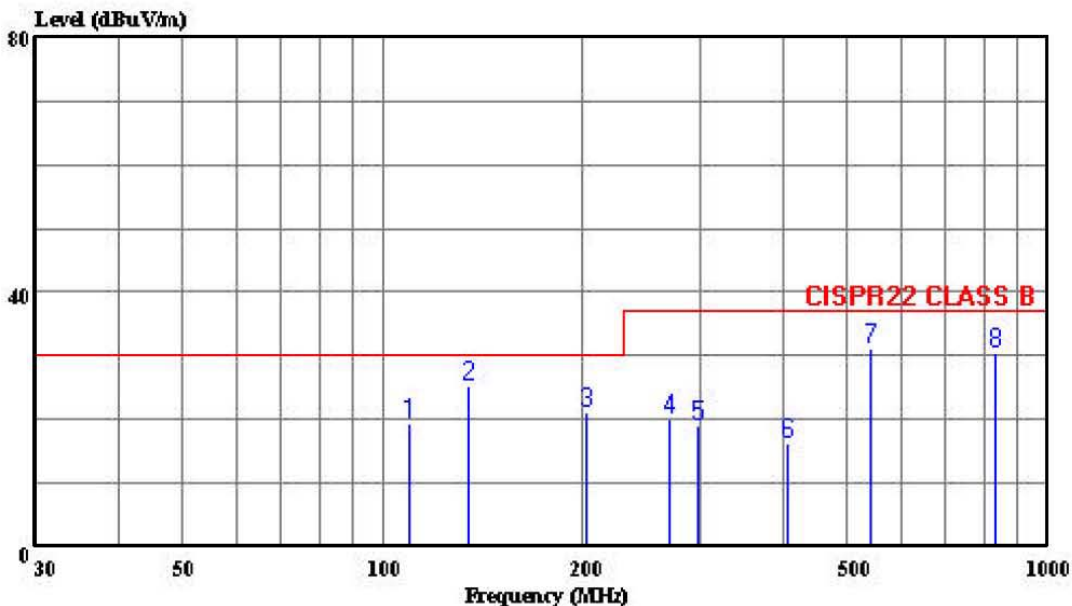

Trace:

Ref Trace:

Condition: CISPR22 CLASS B 10m CHASE 2614 060506 VERTICAL
cut : Component video & digital audio CAT5 Extender
power: 240V/50Hz
memo : CV01A, YE01D

Page: 1

Peak	Freq MHz	Level dBuV/m	Limit dBuV/m	Over Limit dB	ReadAntenna Level dBuV	Cable Factor dB/m	Preamp Loss dB	Remark
1	109.385	19.46	30.00	-10.54	31.77	12.03	1.54	25.88 Peak
2	133.963	25.21	30.00	-4.79	37.85	11.46	1.73	25.83 Peak
3	202.100	21.06	30.00	-8.94	35.53	9.10	2.13	25.71 Peak
4	269.988	20.06	37.00	-16.94	30.41	12.62	2.60	25.56 Peak
5	297.055	19.06	37.00	-17.94	28.75	13.06	2.75	25.50 Peak
6	405.138	16.11	37.00	-20.89	22.26	15.68	3.37	25.20 Peak
7	541.090	31.07	37.00	-5.93	32.47	18.49	4.78	24.68 Peak
8	834.787	30.32	37.00	-6.68	28.69	20.13	5.15	23.65 Peak



HomeTek Technology Inc.

Appendix A

PHOTOS OF TEST CONFIGURATION

PHOTO OF RADIATED EMISSION TEST

Model : CV01A



Front View



Rear View



HomeTek Technology Inc.

Appendix B

PHOTOS OF EUT

PHOTO OF EUT

Model : CV01A, YE01D



Full View of EUT

PHOTO OF EUT

Model : CV0XXX , YE0XXX

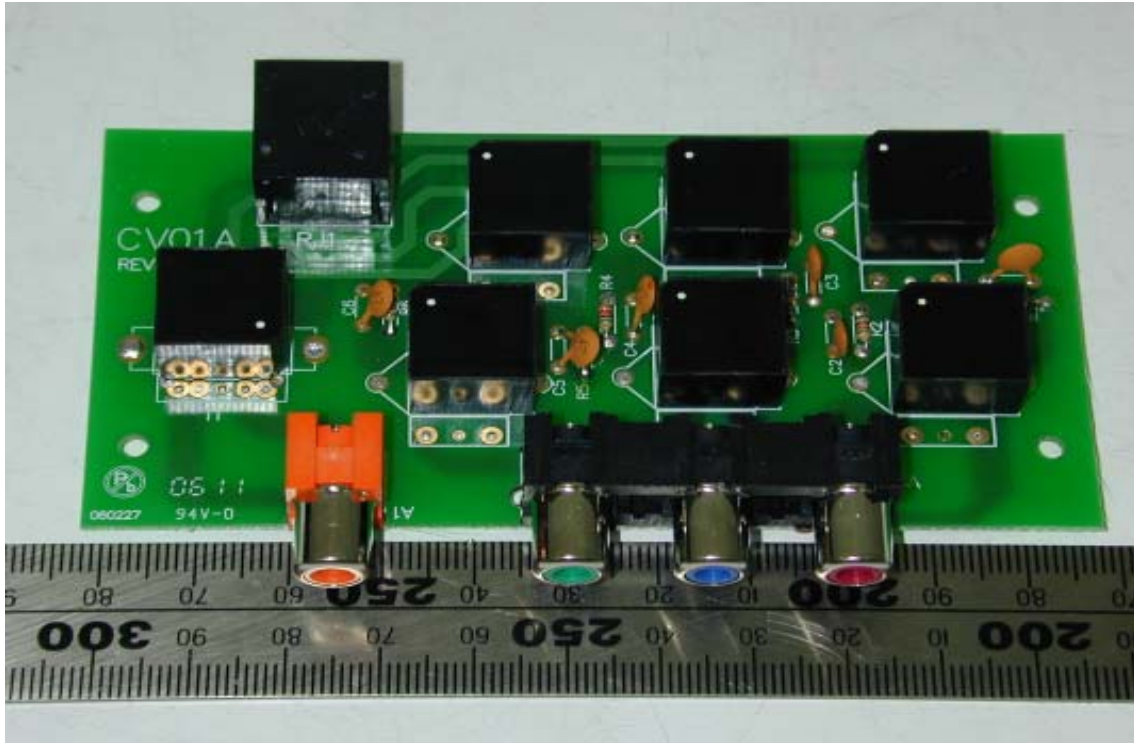

Component Side of Main Board

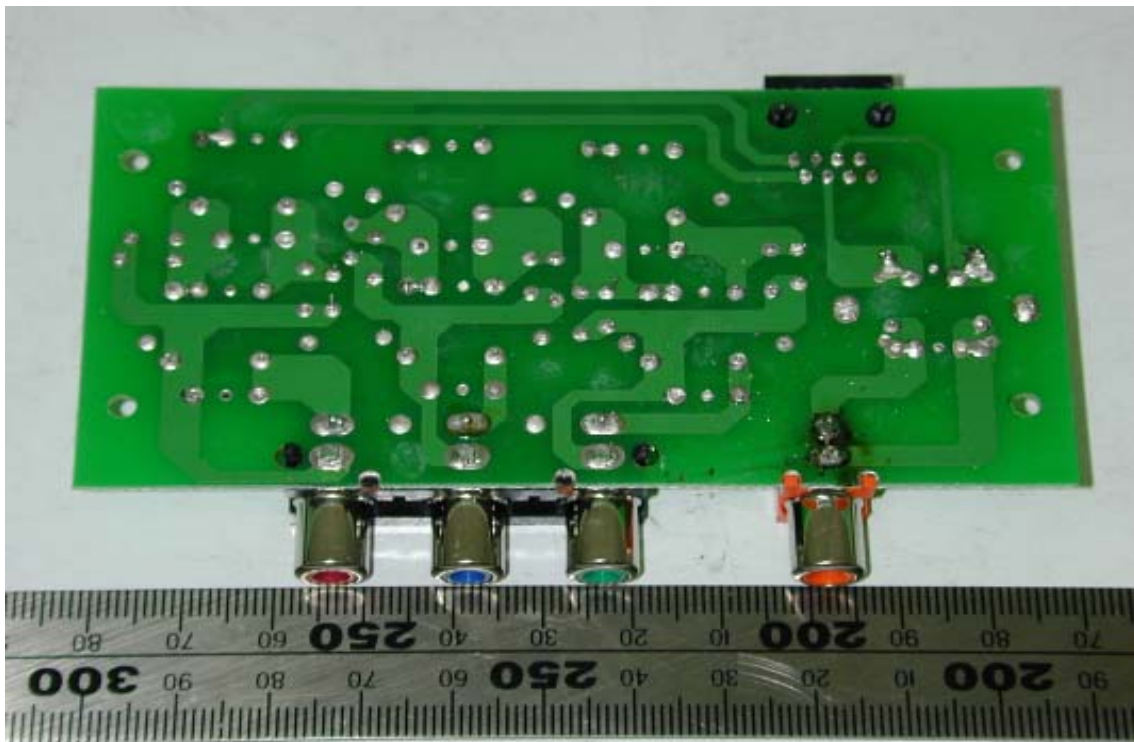

Solder Side of Main Board

Declaration of Conformity

Responsible Party Name :

Address :

Phone No :

Fax No :

Declares under our sole responsibility that the product

Product Name : Component video & digital audio CAT5
Extender

Model No. : CV0XXX, YE0XXX

to which this declaration relates is in conformity with the following standards or other
normative documents

AS/NZS CISPR 22 (2004) : Electromagnetic Interference
– Limits and Methods of Measurement of Information Technology Equipment

Representative Person's Name : _____

Signature : _____

Date : _____

United States Department of Commerce
National Institute of Standards and Technology

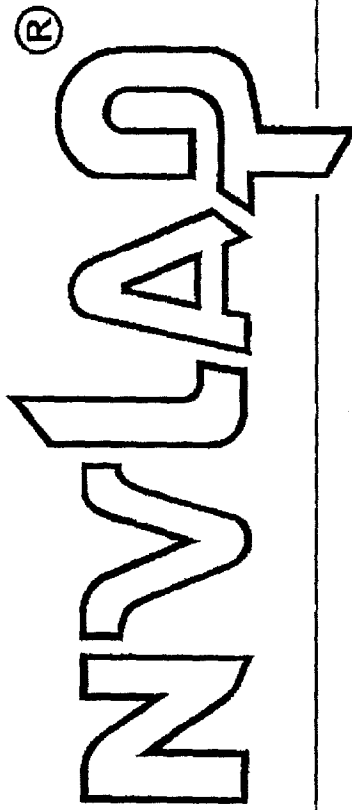

Certificate of Accreditation to ISO/IEC 17025:2005

NVLAP LAB CODE: 200331-0

HomeTek Technology Inc.

Taipei Shien 236
TAIWAN

is recognized by the National Voluntary Laboratory Accreditation Program for conformance with criteria set forth in
NVLAP accreditation documents and all requirements of ISO/IEC 17025:2005.
Accreditation is granted for specific services, listed on the Scope of Accreditation, for:

ELECTROMAGNETIC COMPATIBILITY AND TELECOMMUNICATIONS

2006-10-01 through 2007-09-30

Effective dates

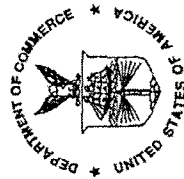

Dally A. Bruce
For the National Institute of Standards and Technology



**National Voluntary
Laboratory Accreditation Program**



SCOPE OF ACCREDITATION TO ISO/IEC 17025:2005

HomeTek Technology Inc.
P.O Box: 13-131, Pan-Chiao City
No. 67-9 Shir Men Rd., Tu Chen City
Taipei Shien 236
TAIWAN
Mr. Grant Huang
Phone: 886-2-22608375 Fax: 886-2-22748013
E-Mail: hometek@ms15.hinet.net

**ELECTROMAGNETIC COMPATIBILITY
AND TELECOMMUNICATIONS**

NVLAP LAB CODE 200331-0

NVLAP Code Designation / Description

Emissions Test Methods:

12/CIS14a	EN 55014-1 (1993), A1 (1997), A2 (1999):
12/CIS14a2	BS EN 55014-1 (2001) with A1 and A2: Electromagnetic compatibility - Requirements for household appliances, electric tools and similar apparatus - Part 1: Emission
12/CIS14b1	AS/NZS CISPR 14-1 (2003): Electromagnetic Compatibility - Requirements for household appliances, electric tools and similar apparatus - Part 1: Emission
12/CIS14c	CNS 13783-1: Electromagnetic Compatibility Requirements for household appliances, electric tools and similar apparatus - Part 1: Emissions
12/CIS14d	IEC/CISPR 14-1 (2001) and A1 (2001): Electromagnetic Compatibility - Requirements for household appliances, electric tools and similar apparatus - Part 1: Emissions
12/CIS14x	IEC/CISPR 14-1, Ed. 4 (2003): Electromagnetic Compatibility - Requirements for household appliances, electric tools and similar apparatus - Part 1: Emission
12/CIS22	IEC/CISPR 22 (1997) & EN 55022 (1998) + A1(2000): Limits and methods of measurement of radio disturbance characteristics of information technology equipment

2006-10-01 through 2007-09-30

Effective dates

Sally S. Bruce
For the National Institute of Standards and Technology



**National Voluntary
Laboratory Accreditation Program**



**ELECTROMAGNETIC COMPATIBILITY
AND TELECOMMUNICATIONS**

NVLAP LAB CODE 200331-0

<i>NVLAP Code</i>	<i>Designation / Description</i>
12/CIS22a	IEC/CISPR 22 (1993) and EN 55022 (1994): Limits and methods of measurement of radio disturbance characteristics of information technology equipment, Amendment 1 (1995) and Amendment 2 (1996)
12/CIS22b	CNS 13438 (1997): Limits and Methods of Measurement of Radio Interference Characteristics of Information Technology Equipment
12/CIS22c	IEC/CISPR 22, Fourth Edition (2003-04) & EN 55022 (1998): Information technology equipment - Radio disturbance characteristics - Limits and methods of measurement
12/FCC15b	ANSI C63.4 (2003) with FCC Method 47 CFR Part 15, Subpart B: Unintentional Radiators
12/T51a	AS/NZS CISPR 22 (2004): Information technology equipment - Radio disturbance characteristics - Limits and methods of measurement
12/VCCIa	VCCI: Agreement of Voluntary Control Council for Interference by Information Technology Equipment - Technical Requirements: V-3/2005.04

2006-10-01 through 2007-09-30

Effective dates

For the National Institute of Standards and Technology