



HomeTek Technology Inc.

ADDRESS: No. 67-9, Shir Men Road, Tu Cheng City,  
Taipei Hsien, Taiwan

PHONE : 886-2-22608375 FAX : 886-2-22748013

E - mail : hometek@ms15.hinet.net

## FCC TEST REPORT FOR

APPLICANT : SMART CABLING & TRANSMISSION CORP.  
ADDRESS : 10F, No. 493, Chung-Cheng Rd.,  
Hsin Tien City, Taipei 231, Taiwan, R. O. C.  
EUT : Digital Audio Transceiver  
MODEL NO. : DA0XXX

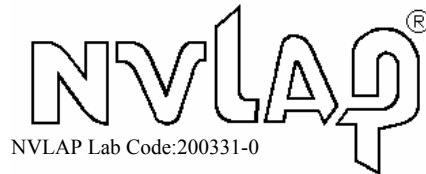

Accredited by the National Voluntary Laboratory Accreditation Program  
for the specific scope of accreditation under Lab Code 200331-0

MEASUREMENT PROCEDURE USED

FCC RULES AND CISPR 22-1997 AND FCC / ANSI C63.4-2003

PREPARED BY :

HomeTek Technology Inc.

No. 67-9, Shir Men Road, Tu Cheng City,

Taipei Hsien. Taiwan

Report # : FD6E029



**TABLE OF CONTENTS**..... 2

**CERTIFICATION**..... 3

**GENERAL INFORMATION**..... 4

**MODIFICATION LIST**..... 5

**CONDUCTED POWER LINE TEST** ..... 6

    1 TEST PROCEDURE..... 6

    2 RESULT OF CONDUCTED EMISSION TEST..... 6

**RADIATED EMISSION TEST**..... 7

    1 TEST INSTRUMENTS & FACILITIES..... 7

    2 TEST PROCEDURE..... 8

    3 TEST SETUP ..... 8

    4 CONFIGURATION OF THE EUT ..... 10

    5 EUT OPERATING CONDITION..... 15

    6 LIMIT OF RADIATED EMISSION CLASS B ..... 16

    7 RESULT OF RADIATED EMISSION TEST..... 17

    8 RADIATED EMISSION TEST DATA (PAGE 1)..... 18

    9 RADIATED EMISSION TEST DATA (PAGE 2)..... 19

**SAMPLE OF FCC DOC LABEL 1** ..... 20

**SAMPLE OF FCC DOC LABEL 2** ..... 20

**APPENDIX A**

PHOTOS OF TEST CONFIGURATION

**APPENDIX B**

PHOTOS OF EUT

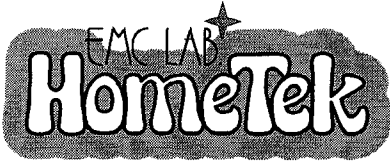

HomeTek Technology Inc.

ADDRESS: No. 67-9, Shir Men Road, Tu Cheng City,  
Taipei Hsien, Taiwan  
PHONE : 886-2-22608375 FAX : 886-2-22748013  
E - mail : hometek@ms15.hinet.net



# CERTIFICATION

for  
FCC Part 15, Subpart B Class B

APPLICANT : SMART CABLING & TRANSMISSION CORP.  
ADDRESS : 10F, No. 493, Chung-Cheng Rd.,  
Hsin Tien City, Taipei 231, Taiwan, R. O. C.  
Receipt Date : 05/15/2007 Final Test Date: 05/29/2007  
EUT : Digital Audio Transceiver  
MODEL NO. : DA0XXX

MEASUREMENT PROCEDURE USED :

PART 15 SUBPART B FCC RULES AND CISPR 22-1997  
AND FCC / ANSI C63.4-2003

TEST PROCEDURE AND DATA ARE TRACEABLE TO NIST/USA,  
TL or NML/TAIWAN.

- THE MAXIMUM EMISSION LEVELS WERE COMPARED TO THE CISPR 22 CLASS B LIMITS BOTH RADIATED AND CONDUCTED EMISSION.
- THE ABOVE DEVICE WAS TESTED BY HOMETEK TECHNOLOGY INC. TO SHOWS THE MAXIMUM EMISSION LEVEL FROM THE DEVICE.
- THIS TEST RESULTS OF THIS REPORT APPLIES TO ABOVE TESTED SAMPLE ONLY.
- THIS TEST REPORT SHALL NOT BE REPRODUCE IN PART WITHOUT WRITTEN APPROVAL OF HOMETEK TECHNOLOGY INC.
- THE REPORT MUST NOT BE USED BY THE CLIENT TO CLAIM PRODUCT ENDORSEMENT BY NVLAP, NIST OR ANY AGENCY OF THE U. S. GOVERNMENT.
- THE TEST RESULTS ARE TRACEABLE TO THE NATIONAL OR INTERNATIONAL STANDARD.

APPROVED BY :  5/31/2007

ALAIN LIN / Supervisor

## GENERAL INFORMATION

- 1 APPLICANT : SMART CABLING & TRANSMISSION CORP.
- 2 ADDRESS : 10F, No. 493, Chung-Cheng Rd.,  
Hsin Tien City, Taipei 231, Taiwan, R. O. C.
- 3 MANUFACTURER : SMART CABLING & TRANSMISSION CORP.
- 4 ADDRESS : 10F, No. 493, Chung-Cheng Rd.,  
Hsin Tien City, Taipei 231, Taiwan, R. O. C.
- 5 DESCRIPTION OF EUT :
- EUT : Digital Audio Transceiver
- FCC ID : N/A
- Model Number : DA0XXX
- Serial # : N/A

5.1 The difference between series of models DA0XXX are as shown below:

- (1) The first and second “X” represents different system input.
- (2) The third “X” represent different accessory.

The PCB layout is similar. The worst case of EMI test data were shown in this test report.

## 6 FEATURES OF EUT :

**Please refer to user manual or product specification.**



HomeTek Technology Inc.

## **MODIFICATION LIST**

THE FOLLOWING ACCESSORIES WERE ADDED TO THE EUT DURING TESTING :

NO MODIFICATION BY HOMETEK TECHNOLOGY INC.

## **CONDUCTED POWER LINE TEST**

### **1 TEST PROCEDURE**

According to **ANSI C63.4 – 2003 & CISPR 22 - 1997**.

### **2 RESULT OF CONDUCTED EMISSION TEST**

N/A (Conducted Power Line Test is not applicable to this EUT ( Model : DA01)).

## RADIATED EMISSION TEST

### 1 TEST INSTRUMENTS & FACILITIES

The following test Instruments was used during the radiated emission test :

Item	Instruments /facilities	Specification	Manufacturer	Model # / S/N#	Date of Cal.
1	OPEN AREA TEST SITE	<input checked="" type="checkbox"/> OATS 3			JUL/2006
2	EMI TEST RECEIVER	20Hz ~ 26.5GHz	ROHDE & SCHWARZ	ESMI 845442/006	FEB/2007
3	PRE-AMPLIFIER	9KHz ~ 3000MHz	ADVANTEST	BB525C 90081001	OCT/2006
4	ANTENNA (BI-LOG)	25MHz ~ 2GHz	SCHAFFNER	CBL6112B S/N : 2614	JUN/2006
5	Attenuation	50Ω/6dB	JYE BAO	FAT-N (M-F) 001	JUL/2006
6	Cable	10m	SUHNER	RG214/U OS3-003	DEC/2006
7	Cable	14m	BELDEN	9913 OS3-001	DEC/2006
8	EMI 32 (software)	N/A	AUDIX	19991013-0923	N/A

Note : Items 1 ~ 7 were calibrated within period of 1 year.

## 2 TEST PROCEDURE

- 2.1 The EUT was test according to **ANSI C63.4 – 2003 Section 5.4, 5.5, 8.1, 8.2, 8.3 & CISPR 22 - 1997 & C18-01-11 (HomeTek test procedure)**.
- 2.2 The radiated test was performed at HomeTek Lab's Open Site III.
- 2.3 The frequency range from 30 MHz to 1 GHz, the measurement were made at 10 meters, with a BI-log antenna.

## 3 TEST SETUP

### 3.1 TEST SETUP OF OPEN SITE.

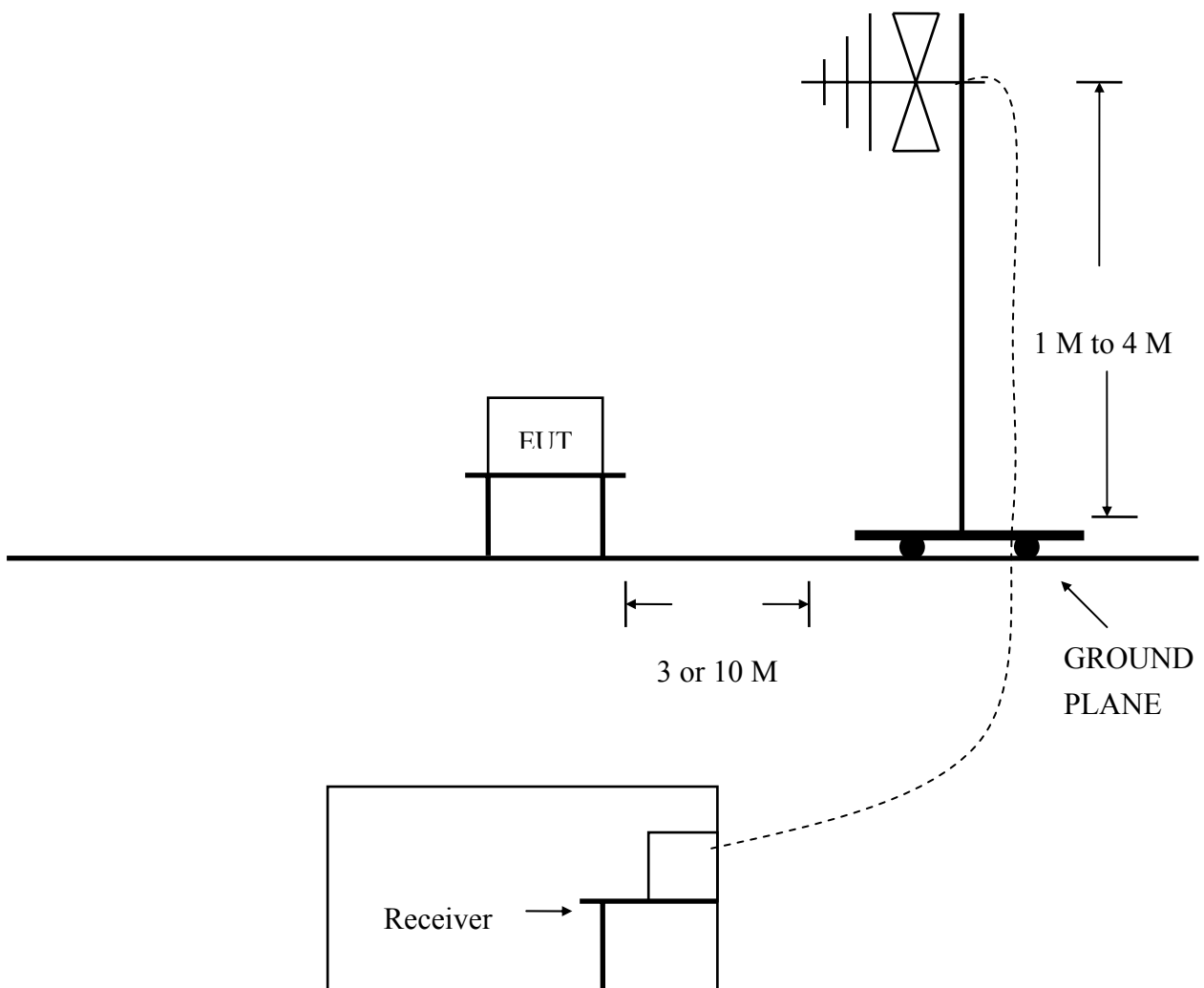

### 3.2 TEST SETUP OF EUT

ELECTRICAL AND ELECTRONIC EQUIPMENT IN THE RANGE OF 9kHz TO 40 GHz

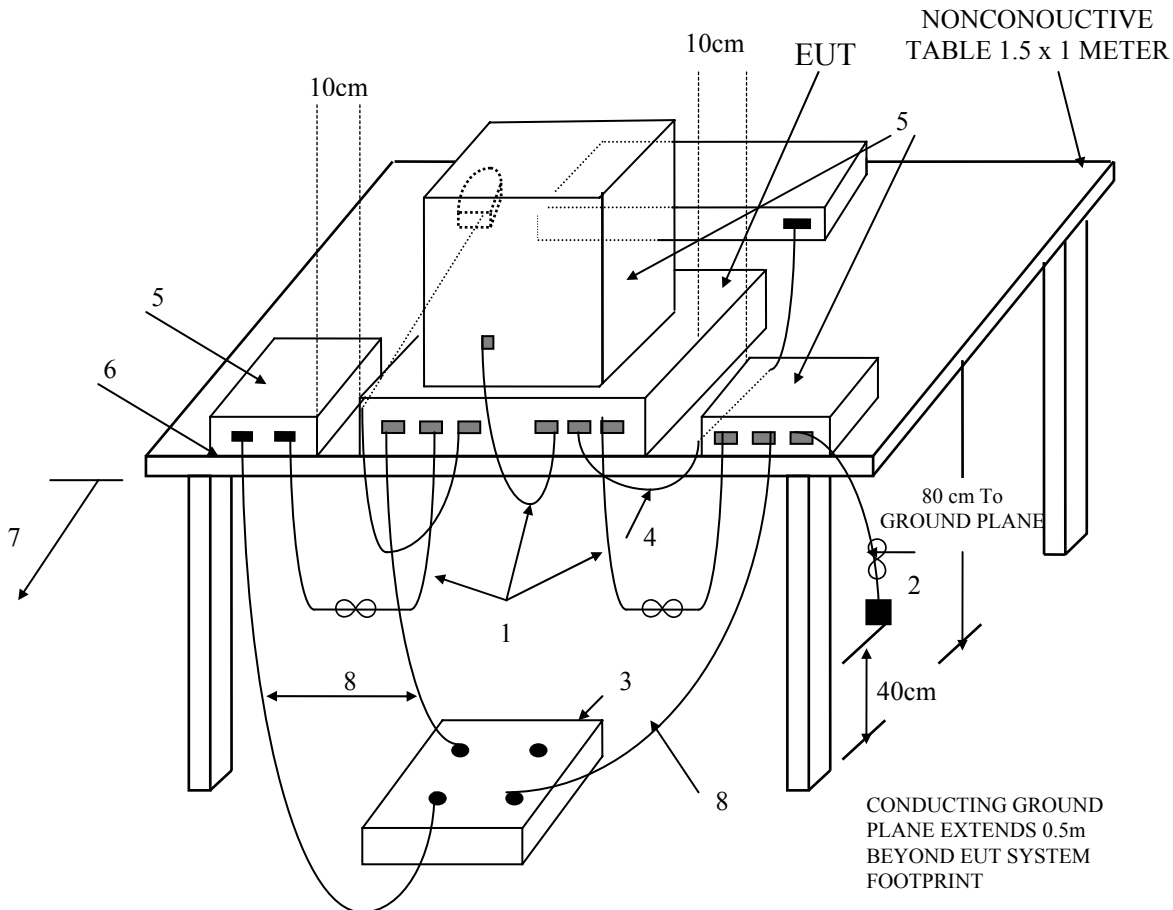
ANSI  
C63.4-2003

(Details for setup configuration, please refer to appendix A.)

#### LEGEND:

1. Interconnecting cables that hang closer than 40 cm to the ground plane shall be folded back and forth forming a bundle 30 to 40 cm long, hanging approximately in the middle between ground plane and table.
2. I/O cables that are connected to a peripheral shall be bundled in center. The end of the cable may be terminated if required using correct terminating impedance. The total length shall not exceed 1m.
3. If LISNs are kept in the test setup for radiated emissions, it is preferred that they be installed under the ground plane with the receptacle flush with the ground plane.
4. Cables of hand-operated devices, such as keyboards, mice, etc., have to be placed as close as possible to the controller.
5. Non-EUT components of EUT system being tested.
6. The rear of all components of the system under test shall be located flush with the rear of the table.
7. No vertical conducting wall used.
8. Power cords drape to the floor and are routed over to receptacle.

#### Test Configuration Tabletop Equipment Radiated Emission

#### 4 CONFIGURATION OF THE EUT

The EUT was configured according to **ANSI C63.4 - 2003 & CISPR 22 - 1997**. All I/O ports were connected to the appropriate peripherals. All peripherals and cables are listed below (including internal device) :

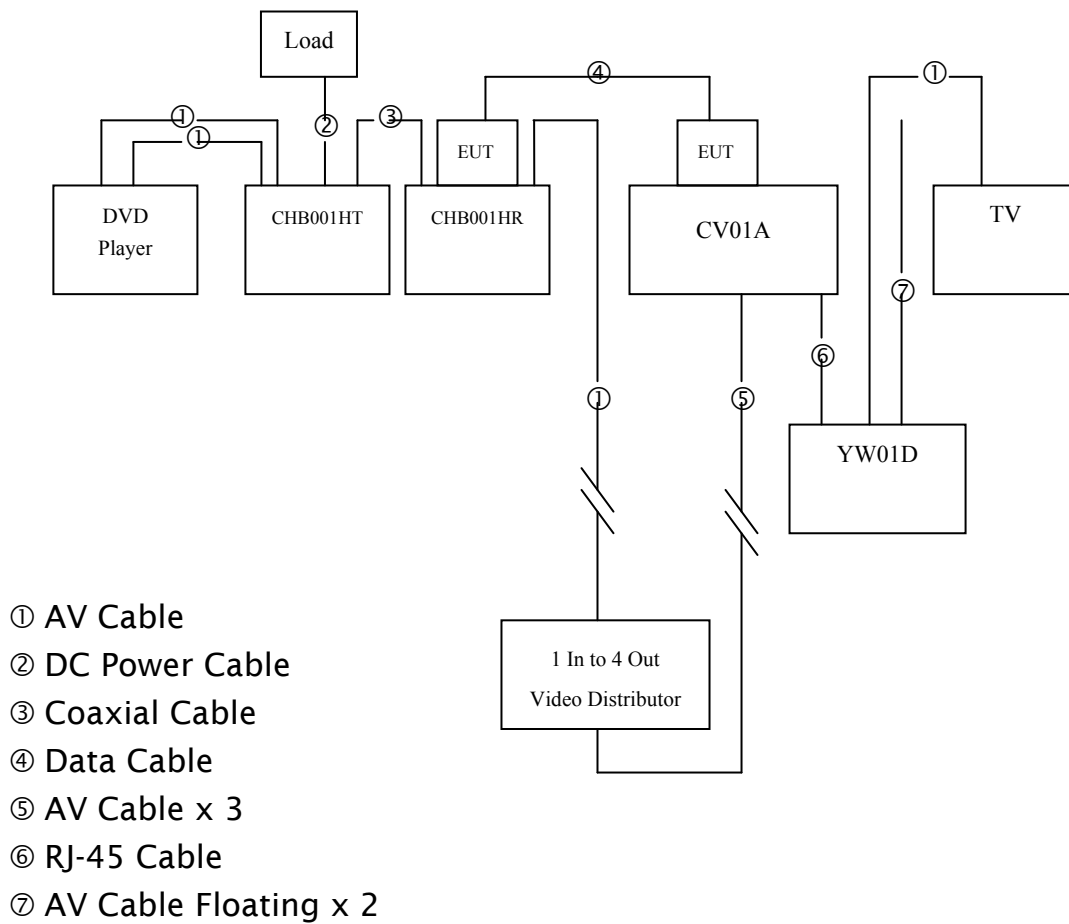

Figure 1



4.1 EUT

EUT Type : Proto Type Engineer Type Mass Production  
Condition when received : Good Damage : \_\_\_\_\_  
Device : Digital Audio Transceiver  
Applicant : SMART CABLING & TRANSMISSION CORP.  
Manufacturer : SMART CABLING & TRANSMISSION CORP.  
Model Number : DA0XXX  
Serial Number : N/A  
FCC ID : N/A  
Data Port : Plastics Type Connector  
RCA Port : Metal Type Connector  
Power Cord : N/A  
Power Supply Type : N/A

4.2 PERIPHERALS

Component video & digital audio CAT5 Extender

Manufacturer : SMART CABLING & TRANSMISSION CORP.  
Model Number : CV01A  
Serial Number : N/A  
FCC ID : N/A  
Data Cable 1 : Un-Shielded, 0.1 m, Connected to the RJ-45 port  
Data Cable 2 x 3 : Un-Shielded, 10 m, Connected to the AV port  
Power Cord : N/A



Hi Frequency Interference Blocker

Manufacturer : SMART CABLING & TRANSMISSION CORP.  
Model Number : CHB001HT  
Serial Number : N/A  
FCC ID : N/A  
Data Cable 1 x 2 : Un-Shielded, 1.6 m, Connected to the AV port  
Data Cable 2 : Shielded, 1.8 m, Connected to the Coaxial port  
Power Cord : Un-Shielded, 1.8 m

Hi Frequency Interference Blocker

Manufacturer : SMART CABLING & TRANSMISSION CORP.  
Model Number : CHB001HR  
Serial Number : N/A  
FCC ID : N/A  
Data Cable 1 : Un-Shielded, 10 m, Connected to the AV port  
Data Cable 2 : Shielded, 1.8 m, Connected to the Coaxial port  
Power Cord : Un-Shielded, 1.8 m

Wall Plate Digital Audio Transceiver

Manufacturer : SMART CABLING & TRANSMISSION CORP.  
Model Number : YW01D  
Serial Number : N/A  
FCC ID : N/A  
Data Cable 1 : Un-Shielded, 0.1 m, Connected to the RJ-45 port  
Data Cable 2 : Un-Shielded, 1.6 m, Connected to the AV port  
Power Cord : N/A

1 In to 4 Out Video Distributor

Manufacturer : SMART CABLING & TRANSMISSION CORP.  
Model Number : 15-VD14  
Serial Number : N/A  
FCC ID : N/A  
Data Cable x 4 : Un-Shielded, 0.6 m, Connected to the AV port  
Power Cord & Adaptor : Un-Shielded, 1.8 m

DVD Player

Manufacturer : LG  
Model Number : DS8421N  
Serial Number : N/A  
FCC ID : N/A  
Data Cable : Shielded, 1.6 m, Connected to the AV port  
Power Cord & Adaptor : Un-Shielded, 1.8 m

TV

Manufacturer : TCL  
Model Number : 1419A  
Serial Number : 010019502035F0039  
FCC ID : N/A  
Data Cable : Shielded, 1.6 m, Connected to the AV port  
Power Cord : Un-Shielded



Load

Manufacturer : HomeTek

Specification : 20Ω

Serial Number : N/A

FCC ID : N/A

Data Cable : N/A

Power Cord : Un-Shielded, 0.3 m

4.3 REMARK : N/A

## 5 EUT OPERATING CONDITION

5.1 The frequency of the EUT is none.

5.2 The radiated emission in the frequency range from 30 MHz - 1000 MHz was test in a horizontal and vertical polarization at HomeTek Lab's open site III.

5.3

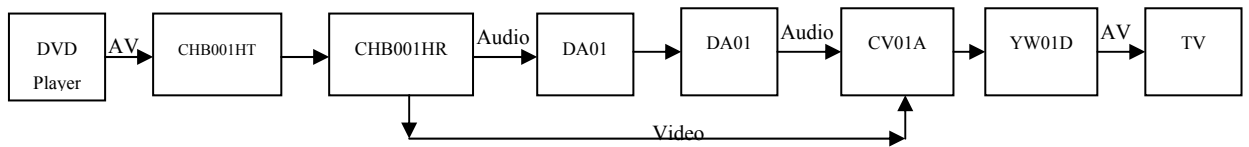

5.4 DVD Player send AV signal to CHB001HT, CHB001HR, DA01 x 2, CV01A, YW01D, and CHB001HT, CHB001HR, DA01 x 2, CV01A, YW01D change AV signal.

5.5 Then has changed AV signal send to TV display.

5.6 Measure the maximum emission noise.

**5.7 The photos of radiated test configuration, please refer to appendix A.**

## 6 LIMIT OF RADIATED EMISSION CLASS B

### CISPR 22

Frequency (MHz)	Measurement Distance	Limit (dBuV/m)
30 - 230	10 (M)	30
230 - 1000	10 (M)	37

- 6.1 The tighter limit shall apply at the edge between two frequency bands.
- 6.2 Measurement distance in meters between the measuring instrument antenna and the closed point of any part of the EUT or peripherals.

## 7 RESULT OF RADIATED EMISSION TEST

- 7.1 The frequency range from 30 MHz to 1 GHz was investigated.
- 7.2 All readings below or equal 1 GHz are quasi-peak or peak values with resolution bandwidth of 120 KHz.
- 7.3 All readings above 1 GHz are average or peak values with resolution bandwidth of 1 MHz
- 7.4 The measurements were made at 10 meters of HomeTek Lab's open site III.
- 7.5 Temperature : 26 °C, Humidity : 56 % RH.
- 7.6 Deviation form the test standards and rules : None
- 7.7 The radiation emission result were gained by the following method :  
Level = Reading Level + Probe Factor (Antenna Factor) + Cable Loss – Preamp Factor  
Over Limit = Level – Limit Line
- 7.8 The radiated mission test was passed at minimum margin :  
Vertical 133.96 MHz/ 25.21 dBuV/m, Antenna Height 2 Meter,  
Turn Table 180 degree, Model : DA01.
- 7.9 Result : **PASSED**



# 8 RADIATED EMISSION TEST DATA (PAGE 1)



HomeTek Technology Inc.

No 67-9, Shi-Men Rd., Tu-Chen City,  
Taipei County, Taiwan R.O.C.  
Tel: 02-22608375  
Fax: 02-22748013

Data#: 2 File#: 6e029.EMI

Date: 2007-05-26 Time: 14:48:24

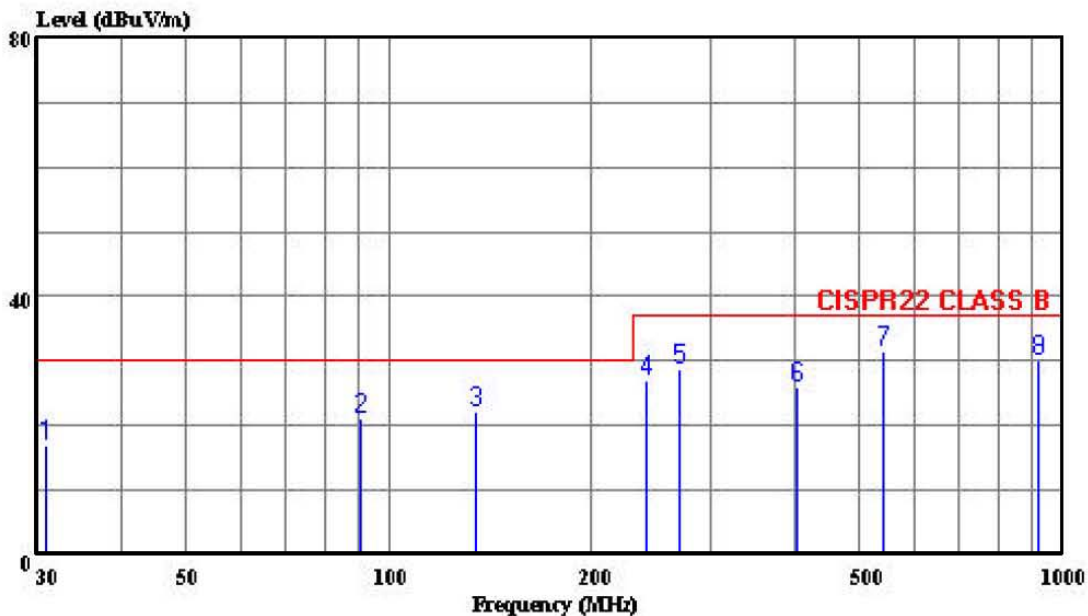

Trace:

Ref Trace:

Condition: CISPR22 CLASS B 10m CHASE 2614 060506 HORIZONTAL  
eui : Digital Audio Transceiver  
power: 110V/60Hz  
memo : DA01

Page: 1

	Freq	Level	Limit	Over	ReadAntenna	Cable	Preamp		
	MHz	dBuV/m	dBuV/m	Limit	Level	Factor	Loss	Factor	Remark
				dB	dBuV	dB/m	dB	dB	
1	30.850	17.09	30.00	-12.91	24.25	18.22	0.64	26.02	Peak
2	90.750	20.97	30.00	-9.03	36.47	9.06	1.36	25.91	Peak
3	133.898	22.33	30.00	-7.67	34.97	11.46	1.73	25.83	Peak
4	241.501	27.11	37.00	-9.89	38.71	11.61	2.42	25.62	Peak
5	270.638	28.70	37.00	-8.30	39.05	12.62	2.60	25.56	Peak
6	404.483	26.07	37.00	-10.93	32.22	15.68	3.37	25.20	Peak
7	541.443	31.39	37.00	-5.61	32.79	18.49	4.78	24.68	Peak
8	920.290	30.21	37.00	-6.79	27.96	20.51	5.13	23.39	Peak
9	920.290	30.21	37.00	-6.79	27.96	20.51	5.13	23.39	Peak

9 RADIATED EMISSION TEST DATA (PAGE 2)



HomeTek Technology Inc.

No 67-9, Shi-Men Rd., Tu-Chen City,  
 Taipei County, Taiwan R.O.C.  
 Tel: 02-22608375  
 Fax: 02-22748013

Data#: 1 File#: 6e029.EMI

Date: 2007-05-26 Time: 13:56:38

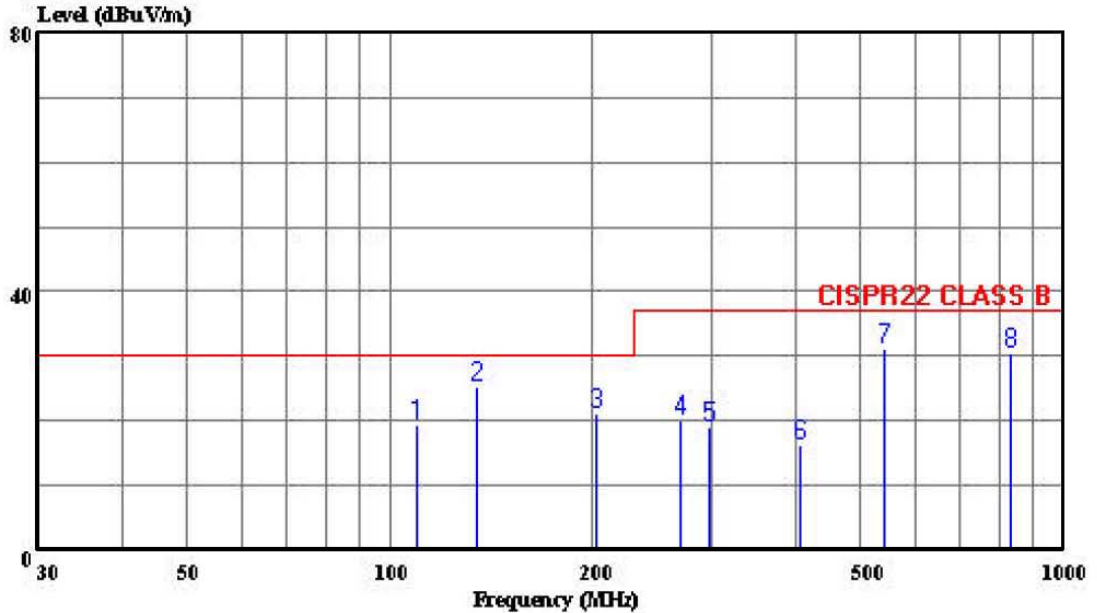

Trace:

Ref Trace:

Condition: CISPR22 CLASS B 10m CHASE 2614 060506 VERTICAL  
 eut : Digital Audio Transceiver  
 power: 110V/60Hz  
 memo : DA01

Page: 1

	Freq	Level	Limit	Over	Read	Antenna	Cable	Preamp	Remark
	MHz	dBuV/m	dBuV/m	dB	Level	Factor	Loss	Factor	
					dBuV	dB/m	dB	dB	
1	109.385	19.46	30.00	-10.54	31.77	12.03	1.54	25.88	Peak
2	133.963	25.21	30.00	-4.79	37.85	11.46	1.73	25.83	Peak
3	202.100	21.06	30.00	-8.94	35.53	9.10	2.13	25.71	Peak
4	269.988	20.06	37.00	-16.94	30.41	12.62	2.60	25.56	Peak
5	297.055	19.06	37.00	-17.94	28.75	13.06	2.75	25.50	Peak
6	405.138	16.11	37.00	-20.89	22.26	15.68	3.37	25.20	Peak
7	541.090	31.07	37.00	-5.93	32.47	18.49	4.78	24.68	Peak
8	834.787	30.32	37.00	-6.68	28.69	20.13	5.15	23.65	Peak

### **SAMPLE OF FCC DoC LABEL 1**

This device complies with part 15 of the FCC Rules.  
Operation is subject to the following two conditions: (1)  
This device may not cause harmful interference. And (2)  
this device must accept any interference received, including  
interference that may cause undesired operation.

### **SAMPLE OF FCC DoC LABEL 2**





HomeTek Technology Inc.

## **Appendix A**

# **PHOTOS OF TEST CONFIGURATION**

## PHOTO OF RADIATED EMISSION TEST

Model : DA01



Front View



Rear View



HomeTek Technology Inc.

## **Appendix B**

# **PHOTOS OF EUT**

## PHOTO OF EUT

Model : DA01



Full View of EUT

# Declaration of Conformity

Responsible Party Name :

Address :

Phone No :

Fax No :

Declares under our sole responsibility that the product

Product Name : Digital Audio Transceiver

Model No. : DA0XXX

to which this declaration relates is in conformity with the following standards or other normative documents

This device complies with Part 15 of the FCC Rules. Operation is subject to the following two conditions : (1) this device may not cause harmful interference, and (2) this device must accept any interference received, including interference that may cause undesired operation.

Representative Person's Name : \_\_\_\_\_

Signature : \_\_\_\_\_

Date : \_\_\_\_\_

United States Department of Commerce  
National Institute of Standards and Technology

**NVLAP**<sup>®</sup>

---

**Certificate of Accreditation to ISO/IEC 17025:2005**

---

NVLAP LAB CODE: 200331-0

**HomeTek Technology Inc.**

Taipei Shien 236  
TAIWAN

is recognized by the National Voluntary Laboratory Accreditation Program for conformance with criteria set forth in  
NVLAP accreditation documents and all requirements of ISO/IEC 17025:2005.  
Accreditation is granted for specific services, listed on the Scope of Accreditation, for:

**ELECTROMAGNETIC COMPATIBILITY AND TELECOMMUNICATIONS**

2006-10-01 through 2007-09-30

Effective dates

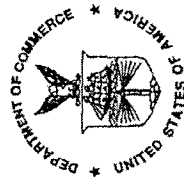

*Dally A. Bruce*  
For the National Institute of Standards and Technology



**National Voluntary  
Laboratory Accreditation Program**



**SCOPE OF ACCREDITATION TO ISO/IEC 17025:2005**

**HomeTek Technology Inc.**  
P.O Box: 13-131, Pan-Chiao City  
No. 67-9 Shir Men Rd., Tu Chen City  
Taipei Shien 236  
TAIWAN  
Mr. Grant Huang  
Phone: 886-2-22608375 Fax: 886-2-22748013  
E-Mail: hometek@ms15.hinet.net

**ELECTROMAGNETIC COMPATIBILITY  
AND TELECOMMUNICATIONS**

**NVLAP LAB CODE 200331-0**

*NVLAP Code Designation / Description*

**Emissions Test Methods:**

12/CIS14a	EN 55014-1 (1993), A1 (1997), A2 (1999):
12/CIS14a2	BS EN 55014-1 (2001) with A1 and A2: Electromagnetic compatibility - Requirements for household appliances, electric tools and similar apparatus - Part 1: Emission
12/CIS14b1	AS/NZS CISPR 14-1 (2003): Electromagnetic Compatibility - Requirements for household appliances, electric tools and similar apparatus - Part 1: Emission
12/CIS14c	CNS 13783-1: Electromagnetic Compatibility Requirements for household appliances, electric tools and similar apparatus - Part 1: Emissions
12/CIS14d	IEC/CISPR 14-1 (2001) and A1 (2001): Electromagnetic Compatibility - Requirements for household appliances, electric tools and similar apparatus - Part 1: Emissions
12/CIS14x	IEC/CISPR 14-1, Ed. 4 (2003): Electromagnetic Compatibility - Requirements for household appliances, electric tools and similar apparatus - Part 1: Emission
12/CIS22	IEC/CISPR 22 (1997) & EN 55022 (1998) + A1(2000): Limits and methods of measurement of radio disturbance characteristics of information technology equipment

2006-10-01 through 2007-09-30

*Effective dates*

*Sally S. Bruce*  
For the National Institute of Standards and Technology



**National Voluntary  
Laboratory Accreditation Program**



**ELECTROMAGNETIC COMPATIBILITY  
AND TELECOMMUNICATIONS**

**NVLAP LAB CODE 200331-0**

<i>NVLAP Code</i>	<i>Designation / Description</i>
12/CIS22a	IEC/CISPR 22 (1993) and EN 55022 (1994): Limits and methods of measurement of radio disturbance characteristics of information technology equipment, Amendment 1 (1995) and Amendment 2 (1996)
12/CIS22b	CNS 13438 (1997): Limits and Methods of Measurement of Radio Interference Characteristics of Information Technology Equipment
12/CIS22c	IEC/CISPR 22, Fourth Edition (2003-04) & EN 55022 (1998): Information technology equipment - Radio disturbance characteristics - Limits and methods of measurement
12/FCC15b	ANSI C63.4 (2003) with FCC Method 47 CFR Part 15, Subpart B: Unintentional Radiators
12/T51a	AS/NZS CISPR 22 (2004): Information technology equipment - Radio disturbance characteristics - Limits and methods of measurement
12/VCCIa	VCCI: Agreement of Voluntary Control Council for Interference by Information Technology Equipment - Technical Requirements: V-3/2005.04

2006-10-01 through 2007-09-30

*Effective dates*

*For the National Institute of Standards and Technology*