



HomeTek Technology Inc.

ADDRESS: No. 67-9, Shir Men Road, Tu Cheng City,
Taipei Hsien, Taiwan,
PHONE : 886-2-22608375 FAX : 886-2-22748013
E - mail : hometek@ms15.hinet.net



NVLAP Lab Code:200331-0

EMI TEST REPORT FOR

APPLICANT : Smart Home Engineering Corp.
ADDRESS : 10F., No. 493, Chung-Cheng Rd.,
Hsin-Tien City, Taipei 231, Taiwan, R. O. C.
EUT : Multimedia AV Distribution Amplifier
MODEL NO. : DD04XXX

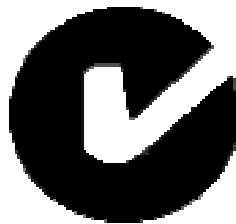

MEASUREMENT PROCEDURE USED

AS/NZS CISPR 22: 2006 Information technology equipment – Radio disturbance characteristics – Limits and methods of measurement

PREPARED BY :
HomeTek Technology Inc.
No. 67-9, Shir Men Road, Tu Cheng City,
Taipei Hsien. Taiwan
Report # : AS6K005



TABLE OF CONTENTS..... 2

CERTIFICATE 3

GENERAL INFORMATION..... 4

MODIFICATION LIST..... 6

CONDUCTED POWER LINE TEST 7

 1 TEST INSTRUMENTS & FACILITIES..... 7

 2 TEST PROCEDURE..... 7

 3 TEST SETUP 8

 4 CONFIGURATION OF THE EUT 10

 5 EUT OPERATING CONDITION..... 14

 6 LIMIT OF CONDUCTED POWER LINE EMISSION CLASS B..... 14

 7 RESULT OF CONDUCTED POWER LINE TEST..... 14

 8 CONDUCTED POWER LINE TEST DATA (PAGE 1)..... 15

 9 CONDUCTED POWER LINE TEST DATA (PAGE 2)..... 16

 10 CONDUCTED POWER LINE TEST DATA (PAGE 3)..... 17

 11 CONDUCTED POWER LINE TEST DATA (PAGE 4)..... 18

RADIATED EMISSION TEST..... 19

 1 TEST INSTRUMENTS & FACILITIES..... 19

 2 TEST PROCEDURE..... 20

 3 TEST SETUP 20

 4 CONFIGURATION OF THE EUT 22

 5 EUT OPERATING CONDITION..... 22

 6 LIMIT OF RADIATED EMISSION CLASS B 22

 7 RESULT OF RADIATED EMISSION TEST..... 22

 8 RADIATED EMISSION TEST DATA (PAGE 1)..... 23

 9 RADIATED EMISSION TEST DATA (PAGE 2)..... 24

APPENDIX A

PHOTOS OF TEST CONFIGURATION

APPENDIX B

PHOTOS OF EUT

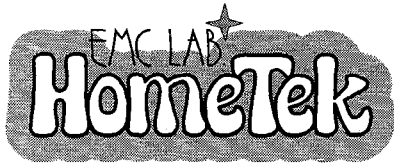

HomeTek Technology Inc.

ADDRESS: No. 67-9, Shir Men Road, Tu Cheng City,
Taipei Hsien, Taiwan
PHONE : 886-2-22608375 FAX : 886-2-22748013
E - mail : hometek@ms15.hinet.net

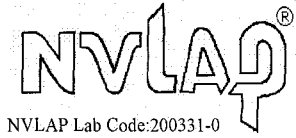

CERTIFICATE

APPLICANT : Smart Home Engineering Corp.
ADDRESS : 10F., No. 493, Chung-Cheng Rd.,
Hsin-Tien City, Taipei 231, Taiwan, R. O. C.
Receipt Date : 11/13/2007 Final Test Date: 11/20/2007
EUT : Multimedia AV Distribution Amplifier
MODEL NO. : DD04XXX

MEASUREMENT PROCEDURE USED :

AS/NZS CISPR 22: 2006 Information technology equipment – Radio
disturbance characteristics – Limits and methods of measurement

- THE MAXIMUM EMISSION LEVELS WERE COMPARED TO THE CISPR 22 CLASS B LIMITS BOTH RADIATED AND CONDUCTED EMISSION.
- THE ABOVE DEVICE WAS TESTED BY HOMETEK TECHNOLOGY INC. TO SHOWS THE MAXIMUM EMISSION LEVEL FROM THE DEVICE.
- THIS TEST RESULTS OF THIS REPORT APPLIES TO ABOVE TESTED SAMPLE ONLY.
- THIS TEST REPORT SHALL NOT BE REPRODUCE IN PART WITHOUT WRITTEN APPROVAL OF HOMETEK TECHNOLOGY INC.
- THE REPORT MUST NOT BE USED BY THE CLIENT TO CLAIM PRODUCT ENDORSEMENT BY NVLAP, NIST OR ANY AGENCY OF THE U. S. GOVERNMENT.
- THE TEST RESULTS ARE TRACEABLE TO THE NATIONAL OR INTERNATIONAL STANDARD.

APPROVED BY : 

ALAIN LIN / Assistant Manage

GENERAL INFORMATION

- 1 APPLICANT : Smart Home Engineering Corp.
- 2 ADDRESS : 10F., No. 493, Chung-Cheng Rd.,
Hsin-Tien City, Taipei 231, Taiwan, R. O. C.
- 3 MANUFACTURER : Smart Home Engineering Corp.
- 4 ADDRESS : 10F., No. 493, Chung-Cheng Rd.,
Hsin-Tien City, Taipei 231, Taiwan, R. O. C.
- 5 DESCRIPTION OF EUT :
- EUT : Multimedia AV Distribution Amplifier
- Model Number : DD04XXX
- Serial # : N/A

5.1 The difference between series of models DD04XXX are as shown below:

- (1) The first "X" represents different system input.
- (2) The second "X" represent different accessory.
- (3) The third "X" represent different color.

The PCB layout is similar. The worst case of EMI test data were shown in this test report.

6 FEATURES OF EUT :

Please refer to user manual or product specification.

7 TEST MODE :

The EUT were investigated with tree resolution modes shown as below :

- (1) 1920 x 1200 Mode;
- (2) 1280 x 1024 Mode;
- (3) 800 x 600 Mode

The test mode of (1) 1920 x 1200 Mode is worst case, and the final test data were shown in this test report.



MODIFICATION LIST

THE FOLLOWING ACCESSORIES WERE ADDED TO THE EUT DURING TESTING :

NO MODIFICATION BY HOMETEK TECHNOLOGY INC.

CONDUCTED POWER LINE TEST

1 TEST INSTRUMENTS & FACILITIES

The following test Instruments was used during the conducted test :

Item	Instruments/ Facilities	Specification	Manufacturer	Model # S/N	Date Of Cal.
1	EMI Receiver	9KHz ~ 30MHz	ROHDE & SCHWARZ	ESHS 30 844827/007	FEB/2007
2	LISN (for EUT)	50Ω/50uH/100A 150KHz ~ 30MHz	SCHWARZ BECK	NNLK 8121 8121370	OCT/2007
3	LISN (for Support Unit)	50Ω/50uH/10A 9KHz ~ 30MHz	ROHDE & SCHWARZ	ESH3-Z5 846128/007	MAR/2007
4	Terminator	50Ω	N/A	N/A	NOV/2007
5	Attenuation	50Ω/10dB	Mini-Circuit	NAT-10 AT-002	JUL/2007
6	Cable	5.4m	SUHNER	RG-223 CON2-002	AUG/2007
7	ESXS-K1 (software)	Version 2.03b 9KHz ~ 30MHz	ROHDE & SCHWARZ	1082.9678.02 840.913/246	N/A

Note : Items 1 ~ 6 were calibrated within period of 1 year.

2 TEST PROCEDURE

- 2.1 The EUT was tested according to **AS/NZS CISPR 22**.
- 2.2 The EUT was placed 0.4 meter from the conducting wall of shielding room and kept at least 0.8 meter from any other grounded conducting surface.
- 2.3 The frequency range form 0.15 MHz to 30 MHz was investigated.
- 2.4 The LISN used was 50 Ohm / 50 uHenry as specified of **AS/NZS CISPR 22**.
- 2.5 All the support peripherals are connect to the other LISN.
- 2.6 Cables and peripherals were moved to find the maximum emission levels for each frequency.

3 TEST SETUP

3.1 Typical : Setup Of Conducted Test

ELECTRICAL AND ELECTRONIC EQUIPMENT IN THE RANGE OF 9kHz TO 40 GHz AS/NZS CISPR 22

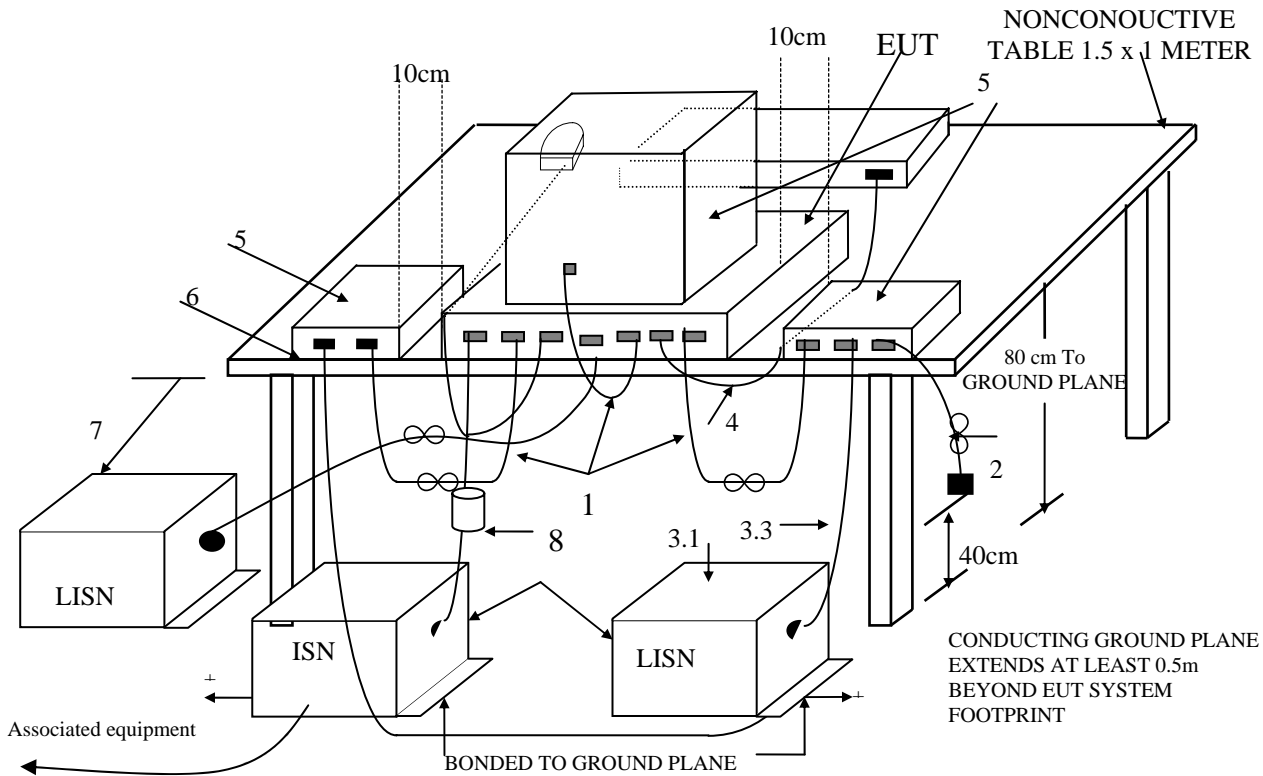

+LISNs may have to be moved to the side to meet 3.3 below.

(Details for setup configuration, please refer to appendix A.)

LEGEND:

1. If cables, which hang closer than 40 cm to the horizontal metal groundplane, cannot be shortened to appropriate length, the excess shall be folded back and forth forming a bundle 30 cm to 40 cm long.
2. Excess mains cord shall be bundled in the centre or shortened to appropriate length.
3. EUT is connected to one artificial mains network (AMN). All AMNs and ISNs may alternatively be connected to a vertical reference plane or metal wall.
 - 3.1 All other units of a system are powered from a second AMN. A multiple outlet strip can be used for multiple mains cords.
 - 3.2 AMN and ISN are 80 cm from the EUT and at least 80 cm from other units and other metal planes.
 - 3.3 Mains cords and signal cables shall be positioned for their entire lengths, as far as possible, at 40 cm from the vertical reference plane.
4. Cables of hand-operated devices, such as keyboards, mice, etc., have to be placed as close as for normal usage.
5. Peripherals shall be placed at a distance of 10 cm from each other and from the controller, except for the monitor which, if this is an acceptable installation practice, shall be placed directly on the top of the controller.
6. I/O signal cable intended for external connection.
7. The end of the I/O signal cables which are not connected to an AE may be terminated, if required, using correct terminating impedance.
8. If used, the current probe shall be placed at 0.1 m from the ISN.

Test Configuration Tabletop Equipment Conducted Emission

3.2 Block Diagram Of Conducted Test

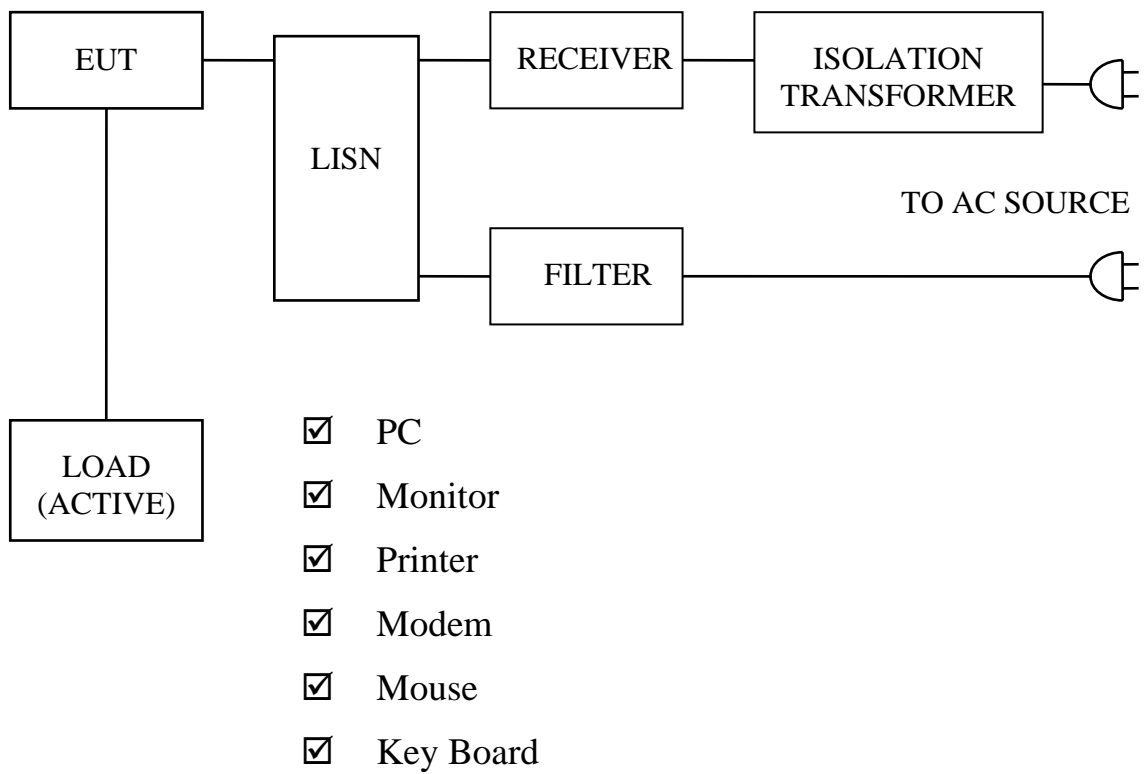

4 CONFIGURATION OF THE EUT

The EUT was configured according to **AS/NZS CISPR 22**. All I/O ports were connected to the appropriate peripherals. All peripherals and cables are listed below (including internal device) :

4.1 EUT

EUT Type : Proto Type Engineer Type Mass Production
Condition when received : Good Damage : _____
Device : Multimedia AV Distribution Amplifier
Applicant : Smart Home Engineering Corp.
Manufacturer : Smart Home Engineering Corp.
Model Number : DD04XXX
Serial Number : N/A
FCC ID : N/A
DVI IN Port : Metal Type Connector
DVI OUT Port : Metal Type Connector
DVI OUT Cable Floating x 3 : Shielded, 2 m, Metal Type Connector
Coaxial Port Cable Floating x 5 : Shielded, 1.5 m, Metal Type Connector
Optical Port Cable Floating x 5 : Metal Type Connector
Power Cord (AC) : 2 pin
Power Cord (DC) : Un-Shielded, 1.8 m, 2 pin
Power Supply Type : Switching Power Adapter



4.2 PERIPHERALS

Host Personal Computer

Manufacturer : HP/COMPAQ
Model Number : D330UT
Serial Number : SGH40606Z1
FCC ID : FCC DoC
Data Cable : Shielded, 1.8 m, Connect to the DVI IN Port
Power Cord : Un-Shielded, 1.8 m

Monitor

Manufacturer : BENQ
Model Number : FP241W
Serial Number : ETLA607230CLO
FCC ID : FCC DoC
Data Cable : Shielded, 1.8 m, Connected to the DVI OUT port
Power Cord : Un-Shielded, 1.8 m

Printer

Manufacturer : HP
Model Number : DJ400
Serial Number : MY77T1D0DD
FCC ID : B94C2642X
Data Cable : Shielded, 1.5 m, Connected to the Printer port
Power Cord & Adaptor : Un-Shielded, 1.8 m



Modem

Manufacturer : ACEEX
Model Number : 1414
Serial Number : 9013522
FCC ID : IFAXDM1414
Data Cable : Shielded, 1.5 m, Connected to the COM port
Power Cord & Adaptor : Un-Shielded, 1.8 m

Mouse (PSII)

Manufacturer : HP
Model Number : M-S69
Serial Number : 334684-002
FCC ID : FCC DoC
Data Cable : Shielded, 1.8 m, Connected to the PSII port
Power Cord : N/A

KeyBoard (PSII)

Manufacturer : HP
Model Number : KB-0133
Serial Number : 323686-AB1
FCC ID : FCC DoC
Data Cable : Shielded, 1.5 m, Connected to the PSII port
Power Cord : N/A



Power Adapter

Manufacturer : DVE

Model Number : ADP051200R-2

Serial Number : N/A

FCC ID : N/A

Data Cable : N/A

Power Cord (DC) : Un-Shielded, 1.8 m

4.3 REMARK : N/A

5 EUT OPERATING CONDITION

- 5.1 The frequency of the EUT is none.
- 5.2 Configure the EUT according to the **AS/NZS CISPR 22**.
- 5.3 The test configuration included PC, Keyboard, Mouse, Printer and Modem.
- 5.4 Turn on all the power of EUT and peripheral.
- 5.5 PC sends data signal (resolutions: 1920 x 1200 / 1280 x 1024 / 800x 600) to Monitor via EUT's HDMI port.
- 5.6 During the test, the PC sends "H" patterns to each I/O port individually. EUT display "H" character.
- 5.7 Adjust the location of EUT and peripheral to gain the maximum EMI noise.
- 5.8 The photos of conducted test configuration, please refer to appendix A.**

6 LIMIT OF CONDUCTED POWER LINE EMISSION CLASS B

AS/NZS CISPR 22

Frequency Range	Quasi Peak	Average
0.15 ~ 0.5 MHz	66 - 56 dBuV	56 - 46 dBuV
0.5 ~ 5 MHz	56 dBuV	46 dBuV
5 ~ 30 MHz	60 dBuV	50 dBuV

- 6.1 In the above table, the tighter limit applies at the band edges.

7 RESULT OF CONDUCTED POWER LINE TEST

- 7.1 The frequency range from 0.15 MHz to 30 MHz was investigated. All readings are quasi-peak values and average.
- 7.2 IF bandwidth : 9 kHz, Meas Time : 1 sec.
- 7.3 Temperature : 26 °C, Humidity : 55 % RH.
- 7.4 Uncertainty in conducted emission measurement : ± 2.90dB.
- 7.5 The conducted test result were gained by following procedures :
 Level = Reading Level + Insertion Loss of LISN + Cable Loss
 (All calculation were done by ESHS30 EMI test receiver.)
- 7.6 Result : **PASSED**

8 CONDUCTED POWER LINE TEST DATA (PAGE 1)

HomeTek EMC LAB. TEL :886-2-22608375

12 Nov 2007 11:21

CONDUCTED EMISSIONS

EUT: Multimedia AV Distribution Amplifier
 Manuf: 6k005
 Op Cond: LINE 1
 Operator: alain
 Test Spec: FOR AS/NZS CISPR22 CLASS B
 Comment: AC240V 50Hz
 DD040D 1920x1200
 Result File: 6k00511g.dat :

Prescan Measurement: Detectors: X PK / + AV
 Meas Time: see scan settings
 Subranges: 16
 Acc Margin: 55 dB

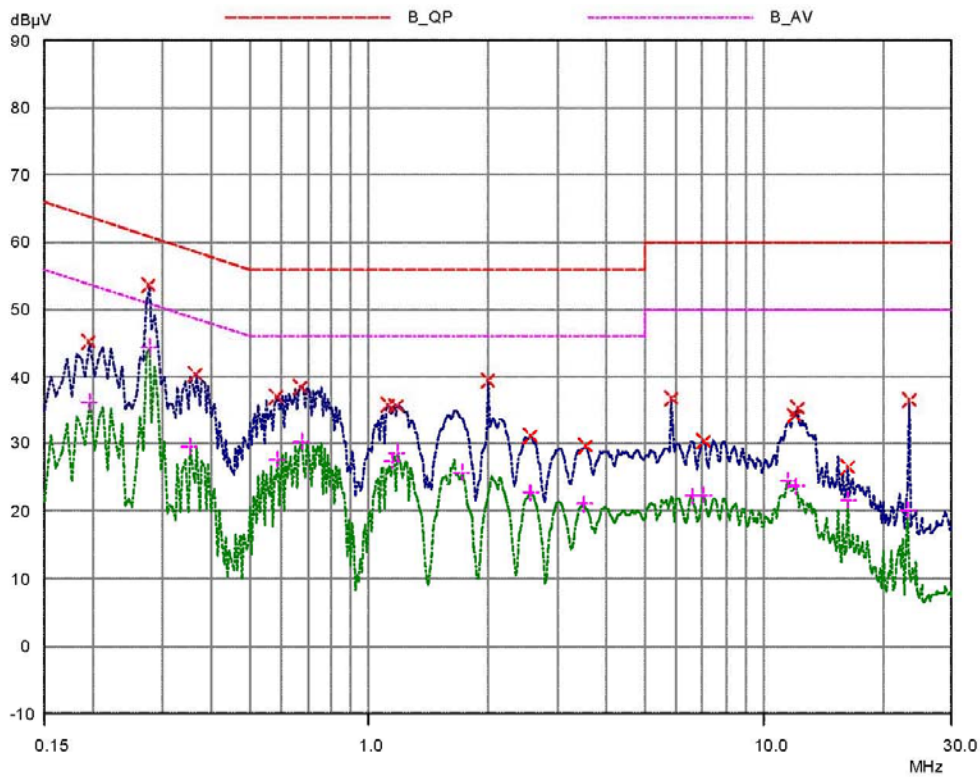



9 CONDUCTED POWER LINE TEST DATA (PAGE 2)

HomeTek EMC LAB. TEL :886-2-22608375

12 Nov 2007 11:21

CONDUCTED EMISSIONS

EUT: Multimedia AV Distribution Amplifier
 Manuf: 6k005
 Op Cond: LINE 1
 Operator: alain
 Test Spec: FOR AS/NZS CISPR22 CLASS B
 Comment: AC240V 50Hz
 DD040D 1920x1200
 Result File: 6K00511g.dat :

Prescan Measurement: Detectors: X PK / + AV
 Meas Time: see scan settings
 Subranges: 16
 Acc Margin: 55 dB

Peak Search Results

Frequency MHz	PK Level dBµV	PK Limit dBµV	PK Delta dB
0.195	45.14	63.82	18.68
0.275	53.53	60.97	7.44
0.365	40.45	58.61	18.16
0.585	37.13	56.00	18.87
0.675	38.56	56.00	17.44
1.122	35.80	56.00	20.20
1.171	35.74	56.00	20.26
1.997	39.53	56.00	16.47
2.557	31.01	56.00	24.99
3.53	29.54	56.00	26.46
5.8	36.72	60.00	23.28
7.0	30.41	60.00	29.59
11.89	34.28	60.00	25.72
12.11	35.44	60.00	24.56
16.29	26.60	60.00	33.40
23.4	36.64	60.00	23.36

Frequency MHz	AV Level dBµV	AV Limit dBµV	AV Delta dB
0.195	36.26	53.82	17.56
0.275	44.44	50.97	6.53
0.35	29.58	48.96	19.38
0.585	27.65	46.00	18.35
0.675	30.23	46.00	15.77
1.143	27.39	46.00	18.61
1.171	28.55	46.00	17.45
1.717	25.71	46.00	20.29
2.557	22.67	46.00	23.33
3.488	21.04	46.00	24.96
6.57	22.16	50.00	27.84
7.0	22.34	50.00	27.66
11.49	24.46	50.00	25.54
12.02	23.64	50.00	26.36
16.29	21.58	50.00	28.42
23.13	20.12	50.00	29.88

* limit exceeded

10 CONDUCTED POWER LINE TEST DATA (PAGE 3)

HomeTek EMC LAB. TEL :886-2-22608375

12 Nov 2007 11:33

CONDUCTED EMISSIONS

EUT: Multimedia AV Distribution Amplifier
 Manuf: 6k005
 Op Cond: LINE 2
 Operator: alain
 Test Spec: FOR AS/NZS CISPR22 CLASS B
 Comment: AC240V 50Hz
 DD040D 1920x1200
 Result File: 6k00521g.dat :

Prescan Measurement: Detectors: X PK / + AV
 Meas Time: see scan settings
 Subranges: 16
 Acc Margin: 55 dB

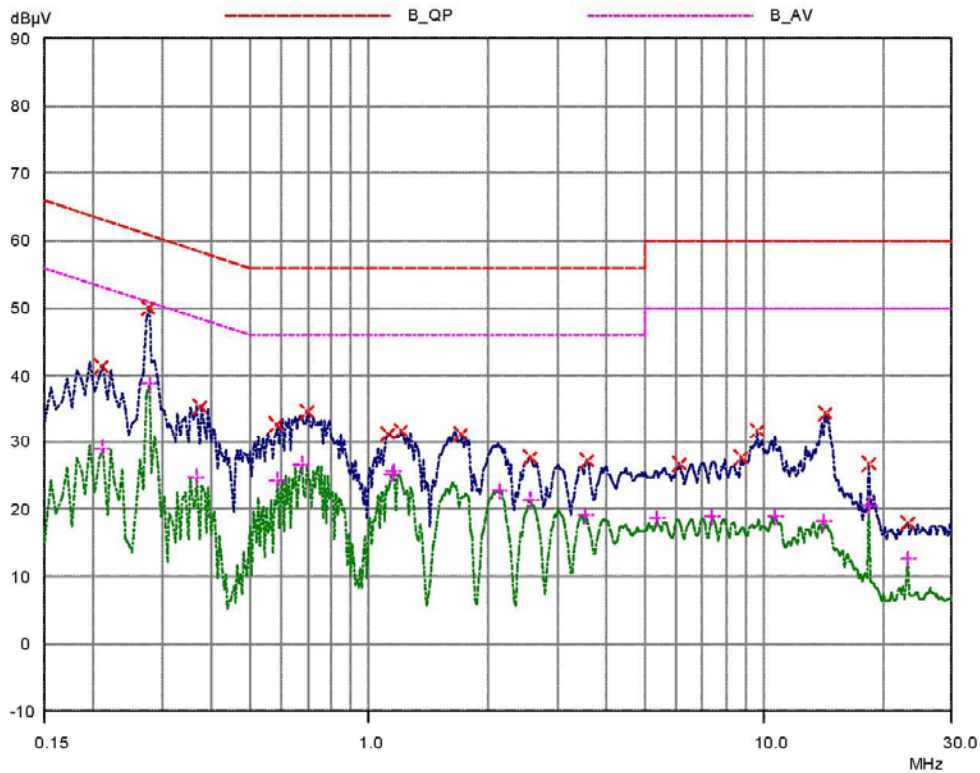



11 CONDUCTED POWER LINE TEST DATA (PAGE 4)

HomeTek EMC LAB. TEL :886-2-22608375

12 Nov 2007 11:33

CONDUCTED EMISSIONS

EUT: Multimedia AV Distribution Amplifier
 Manuf: 6k005
 Op Cond: LINE 2
 Operator: alain
 Test Spec: FOR AS/NZS CISPR22 CLASS B
 Comment: AC240V 50Hz
 DD040D 1920x1200
 Result File: 6K00521g.dat :

Prescan Measurement: Detectors: X PK / + AV
 Meas Time: see scan settings
 Subranges: 16
 Acc Margin: 55 dB

Peak Search Results

Frequency MHz	PK Level dBµV	PK Limit dBµV	PK Delta dB
0.21	41.45	63.21	21.76
0.275	50.13	60.97	10.84
0.375	35.39	58.39	23.00
0.585	32.63	56.00	23.37
0.7	34.64	56.00	21.36
1.122	31.33	56.00	24.67
1.206	31.71	56.00	24.29
1.71	31.20	56.00	24.80
2.55	27.72	56.00	28.28
3.551	27.23	56.00	28.77
6.07	26.68	60.00	33.32
8.7	27.60	60.00	32.40
9.6	31.73	60.00	28.27
14.23	34.49	60.00	25.51
18.5	26.71	60.00	33.29
23.13	17.95	60.00	42.05

Frequency MHz	AV Level dBµV	AV Limit dBµV	AV Delta dB
0.21	29.04	53.21	24.17
0.275	38.78	50.97	12.19
0.365	24.70	48.61	23.91
0.585	24.26	46.00	21.74
0.675	26.65	46.00	19.35
1.143	25.26	46.00	20.74
1.157	25.59	46.00	20.41
2.123	22.67	46.00	23.33
2.55	21.43	46.00	24.57
3.516	19.07	46.00	26.93
5.36	18.63	50.00	31.37
7.39	18.82	50.00	31.18
10.63	18.87	50.00	31.13
14.1	18.17	50.00	31.83
18.5	20.48	50.00	29.52
23.13	12.63	50.00	37.37

* limit exceeded

RADIATED EMISSION TEST

1 TEST INSTRUMENTS & FACILITIES

The following test Instruments was used during the radiated emission test :

Item	Instruments /facilities	Specification	Manufacturer	Model # / S/N#	Date of Cal.
1	OPEN AREA TEST SITE	<input checked="" type="checkbox"/> OATS 3			JUL/2007
2	EMI TEST RECEIVER	20Hz ~ 26.5GHz	ROHDE & SCHWARZ	ESMI 845442/006	FEB/2007
3	PRE-AMPLIFIER	9KHz ~ 3000MHz	ADVANTEST	BB525C 90081001	OCT/2007
4	ANTENNA (BI-LOG)	25MHz ~ 2GHz	SCHAFFNER	CBL6112B S/N : 2611	JUN/2007
5	Attenuation	50Ω/6dB	JYE BAO	FAT-N (M-F) 001	JUL/2007
6	Ferrite Clamp	30 ~ 1000MHz	ADT	FC18 910030	DEC/2006
7	Ferrite Clamp	30 ~ 1000MHz	HomeTek	HFC 001	DEC/2006
8	Cable	10m	SUHNER	RG214/U OS3-003	DEC/2006
9	Cable	14m	BELDEN	9913 OS3-001	DEC/2006
10	EMI 32 (software)	N/A	AUDIX	19991013-0923	N/A

Note : Items 1 ~ 9 were calibrated within period of 1 year.

2 TEST PROCEDURE

- 2.1 The EUT was test according to **AS/NZS CISPR 22**.
- 2.2 The radiated test was performed at HomeTek Lab's Open Site 3.
- 2.3 The frequency range from 30 MHz to 1 GHz, the measurement were made at 10 meters, with a BI-log antenna.

3 TEST SETUP

3.1 TEST SETUP OF OPEN SITE.

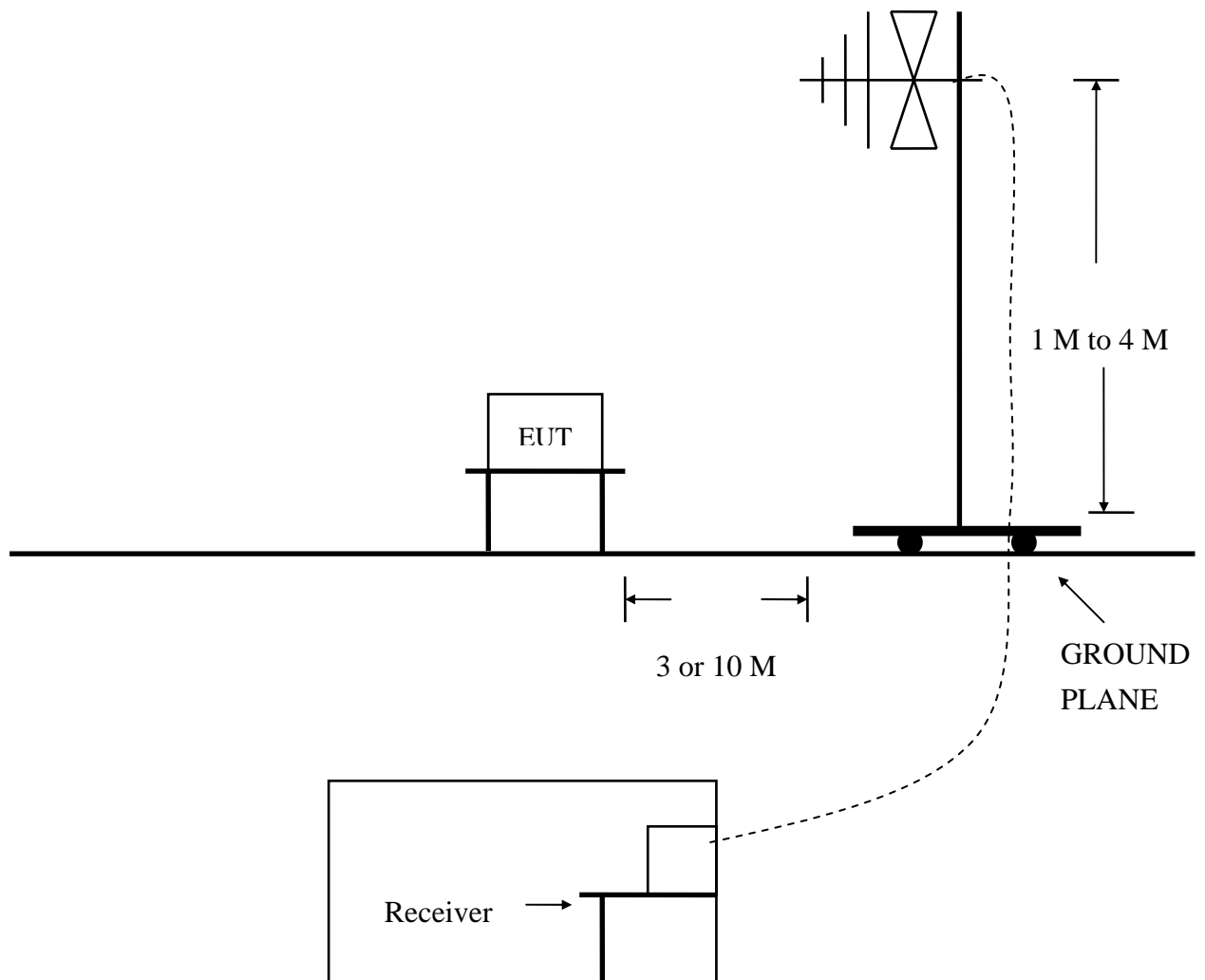

3.2 TEST SETUP OF EUT

ELECTRICAL AND ELECTRONIC EQUIPMENT IN THE RANGE OF 9kHz TO 40 GHz AS
NZS CISPR 22

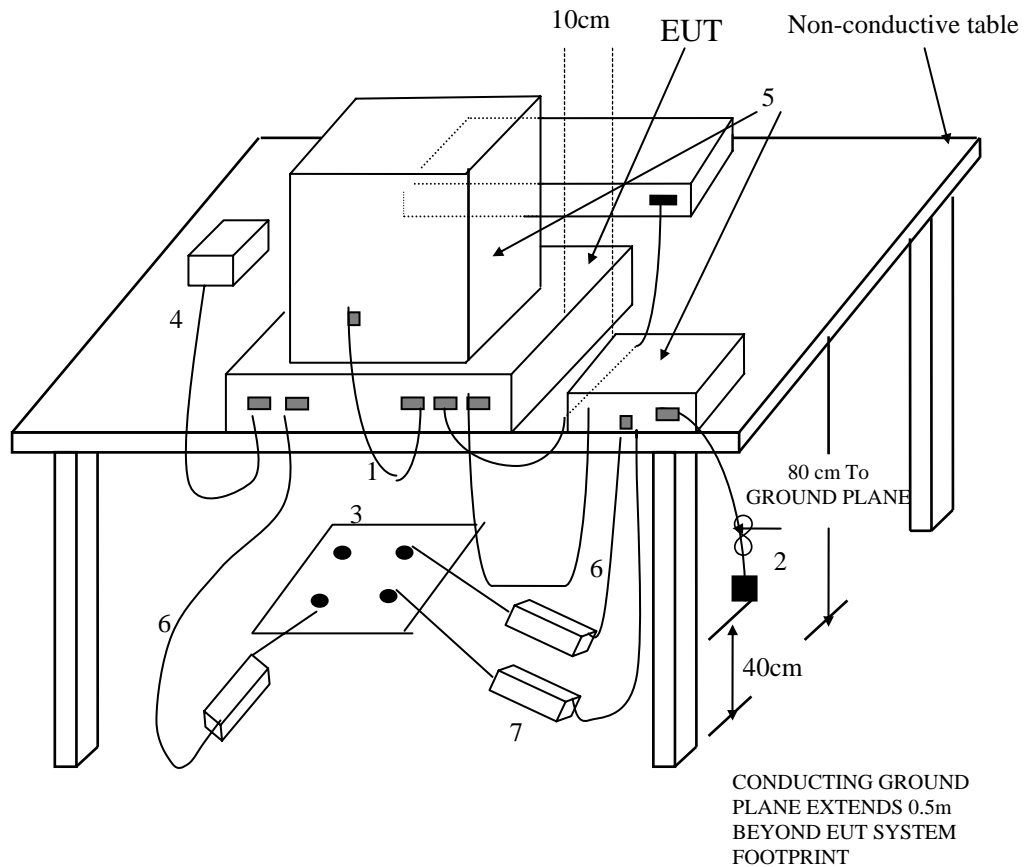

(Details for setup configuration, please refer to appendix A.)

LEGEND:

1. If cables, which hang closer than 40 cm to the horizontal metal ground plane cannot be shortened to the appropriate length, the excess shall be folded back and forth forming a bundle 30 cm to 40 cm long.
2. The end of I/O signal cables which are not connected to a peripheral may be terminated, if required for proper operation using correct terminating impedance.
3. Mains junction box(es) shall be flush with, and bonded directly to, the metal ground plane.
NOTE if used, the AMN shall be installed under the horizontal metal ground plane.
4. Cables of hand-operated devices such as keyboards, mouses, etc. shall be placed as for normal usage.
5. Peripherals shall be placed at a distance of 10 cm from each other and from the controller, except for the monitor which, if for an acceptable installation practice, shall be placed directly on top of the controller.
6. Mains cables, telephone lines or other connections to auxiliary equipment located outside the test area shall drape to the floor, be fitted with ferrite clamps or ferrite tubes placed on the floor at the point where the cable reaches the floor and then routed to the place where they leave the turntable. No extension cords shall be used to mains receptacle.
7. Ferrite clamps or ferrite tubes with similar characteristics (as defined in 10.4). No more than one cable per clamp.

Test Configuration Tabletop Equipment Radiated Emission

4 CONFIGURATION OF THE EUT

Same as “Conducted Power Line test”, section 5

5 EUT OPERATING CONDITION

5.1 Same as “Conducted Power Line test”, section 5

5.2 The radiated emission in the frequency range from 30 MHz - 1000 MHz was test in a horizontal and vertical polarization at HomeTek Lab’s open site 3.

5.3 The photos of radiated test configuration, please refer to appendix A.

6 LIMIT OF RADIATED EMISSION CLASS B

AS/NZS CISPR 22

Frequency (MHz)	Measurement Distance	Limit (dBuV/m)
30 - 230	10 (M)	30
230 - 1000	10 (M)	37

6.1 The tighter limit shall apply at the edge between two frequency bands.

6.2 Measurement distance in meters between the measuring instrument antenna and the closed point of any part of the EUT or peripherals.

7 RESULT OF RADIATED EMISSION TEST

7.1 The frequency range from 30 MHz to 1 GHz was investigated.

7.2 All readings below or equal 1 GHz are quasi-peak or peak values with resolution bandwidth of 120 KHz.

7.3 The measurements were made at 10 meters of HomeTek Lab’s open site 3.

7.4 Temperature : 23 °C, Humidity : 56 % RH.

7.5 Uncertainty in radiated emission measurement : ± 4.18dB.

7.6 The radiated emission result were gained by the following method :

Level = Reading Level + Probe Factor (Antenna Factor) + Cable Loss – Preamp Factor

Over Limit = Level – Limit Line

7.7 Result : **PASSED**



8 RADIATED EMISSION TEST DATA (PAGE 1)



HomeTek Technology Inc.

No 67-9, Shi-Men Rd., Tu-Chen City,
Taipei County, Taiwan R.O.C.
Tel:02-22608375
Fax:02-22748013

Data#: 3 File#: 6K005.EMI

Date: 2007-11-20 Time: 15:31:23

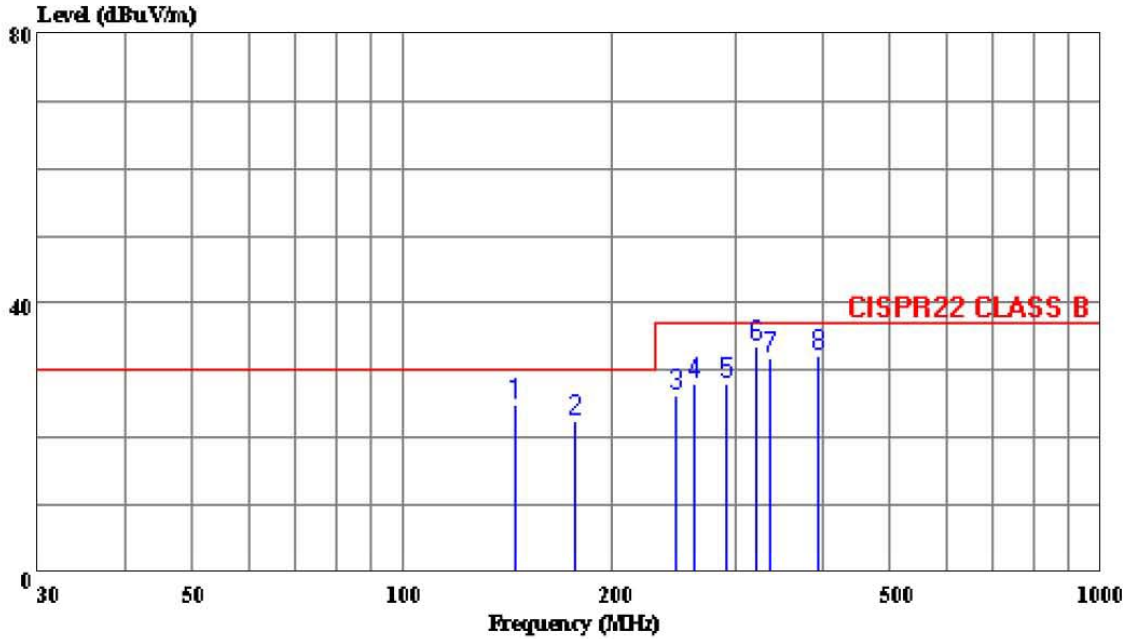

Trace:

Ref Trace:

Condition: CISPR22 CLASS B 10m CHASE 2611 070612 HORIZONTAL
eut : Multimedia AV Distribution Amplifier
power: 240V/50Hz
memo : DD04D(1920*1200)

Page: 1

	Freq	Level	Limit	Over	ReadAntenna	Cable	Preamp	Remark
	MHz	dBuV/m	dBuV/m	dB	Level	Loss	Factor	
					Factor			
					dB/m	dB	dB	
1	145.062	24.95	30.00	-5.05	38.02	10.94	25.81	Peak
2	176.008	22.44	30.00	-7.56	36.85	9.35	25.75	Peak
3	247.219	26.40	37.00	-10.60	37.26	12.30	25.61	Peak
4	261.200	27.90	37.00	-9.10	36.68	14.26	25.58	Peak
5	290.394	27.98	37.00	-9.02	37.69	13.10	25.52	Peak
6	321.059	33.76	37.00	-3.24	42.42	13.87	25.44	QP
7	335.616	31.81	37.00	-5.19	39.95	14.26	25.40	Peak
8	394.290	32.36	37.00	-4.64	38.58	15.68	25.23	Peak



9 RADIATED EMISSION TEST DATA (PAGE 2)



HomeTek Technology Inc.

No 67-9, Shi-Men Rd., Tu-Chen City, Taipei County, Taiwan R.O.C. Tel:02-22608375 Fax:02-22748013

Data#: 4 File#: 6K005.EMI

Date: 2007-11-20 Time: 16:41:57

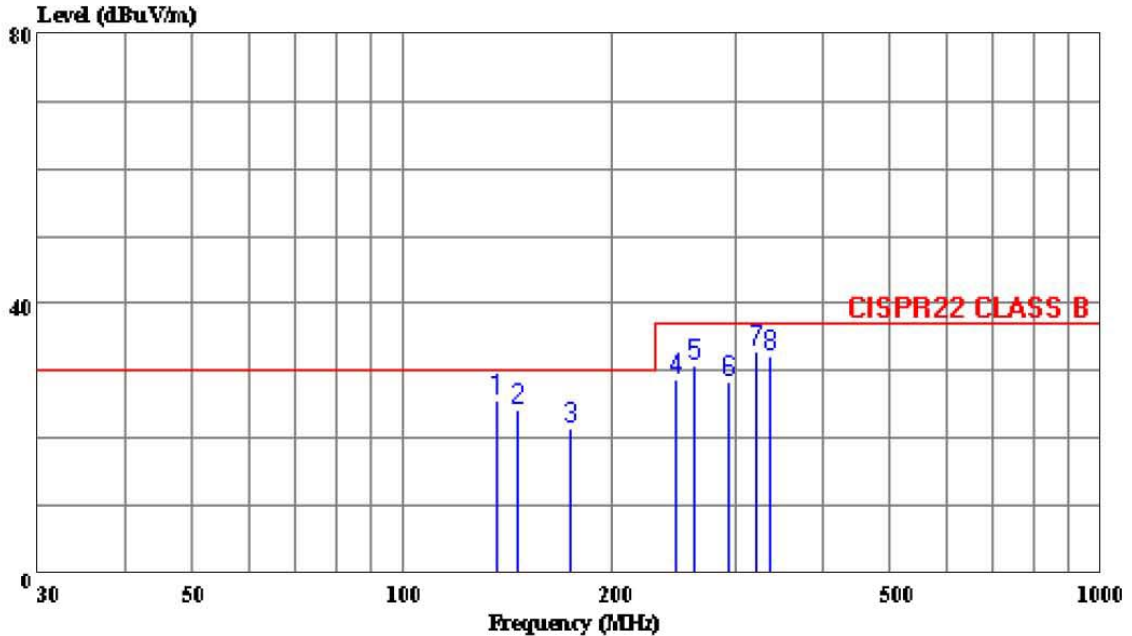

Trace:

Ref Trace:

Condition: CISPR22 CLASS B 10m CHASE 2611 070612 VERTICAL
 eut : Multimedia AV Distribution Amplifier
 power: 240V/50Hz
 memo : DD04D(1920*1200)

Page: 1

	Freq	Level	Limit	Over	ReadAntenna	Cable	Preamp	Remark
	MHz	dBuV/m	dBuV/m	dB	Level	Loss	Factor	
					Factor			
					dB/m	dB	dB	
1	136.940	25.73	30.00	-4.27	38.05	11.75	1.76	25.83 Peak
2	146.091	24.31	30.00	-5.69	37.49	10.82	1.81	25.81 Peak
3	174.029	21.55	30.00	-8.45	35.92	9.41	1.98	25.76 Peak
4	247.094	28.83	37.00	-8.17	39.69	12.30	2.45	25.61 Peak
5	261.029	30.91	37.00	-6.09	39.69	14.26	2.54	25.58 Peak
6	292.309	28.39	37.00	-8.61	38.03	13.16	2.72	25.51 Peak
7	321.091	33.02	37.00	-3.98	41.68	13.87	2.91	25.44 QP
8	335.092	32.09	37.00	-4.91	40.26	14.24	2.99	25.40 Peak



HomeTek Technology Inc.

Appendix A

PHOTOS OF TEST CONFIGURATION

PHOTO OF CONDUCTED POWER LINE TEST

Test Model : DD04D , Test Mode : 1920*1200 Mode



Front View



Rear View

PHOTO OF RADIATED EMISSION TEST

Test Model : DD04D , Test Mode : 1920*1200 Mode



Front View

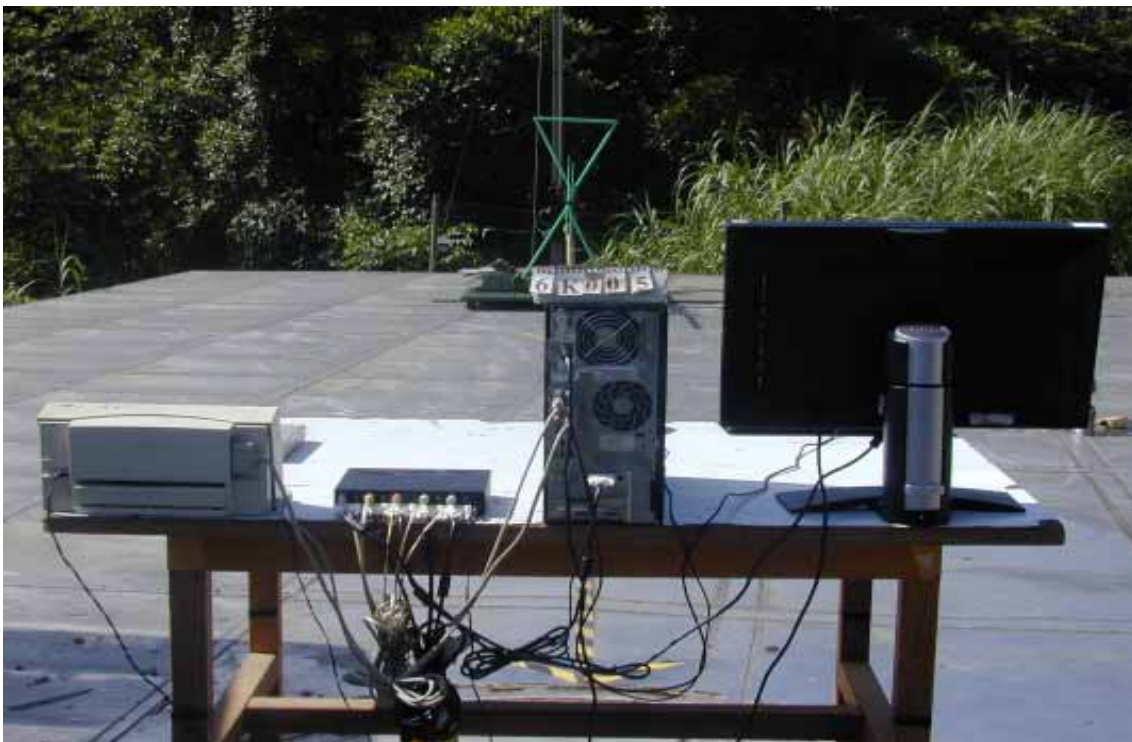

Rear View



HomeTek Technology Inc.

Appendix B

PHOTOS OF EUT

PHOTO OF EUT



Front View of EUT



Rear View of EUT

PHOTO OF EUT



Inside View of EUT



Case Inside View of EUT

PHOTO OF EUT

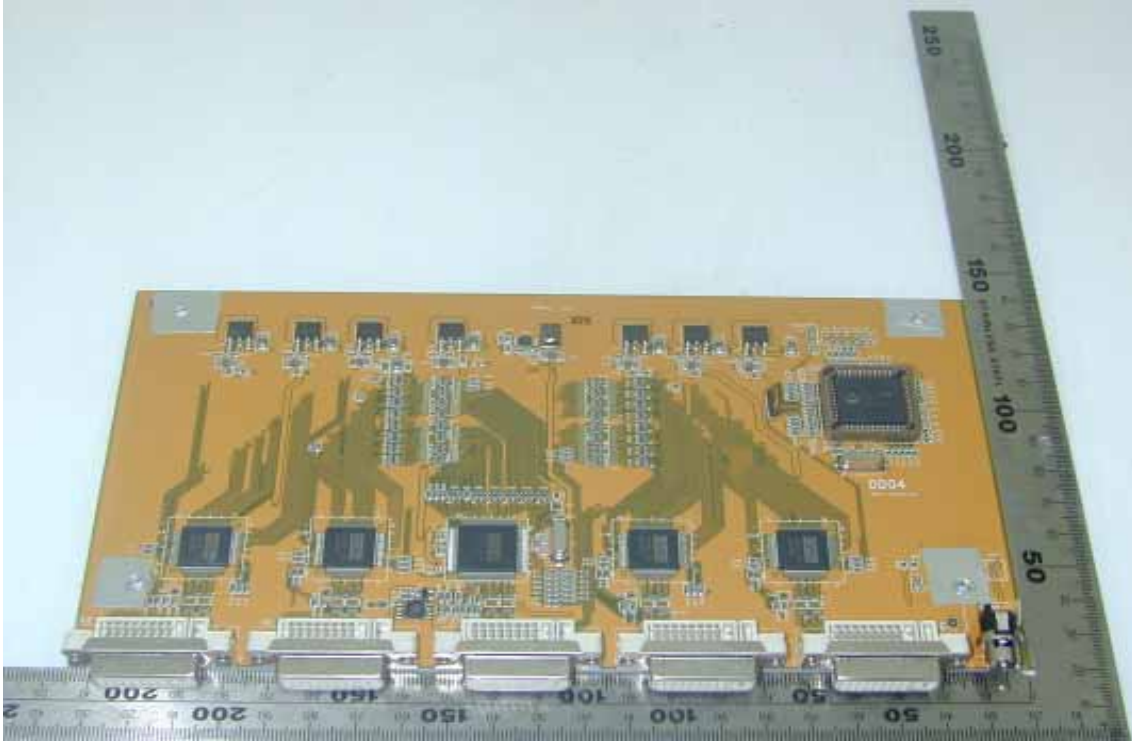

Component Side of Main Board 1

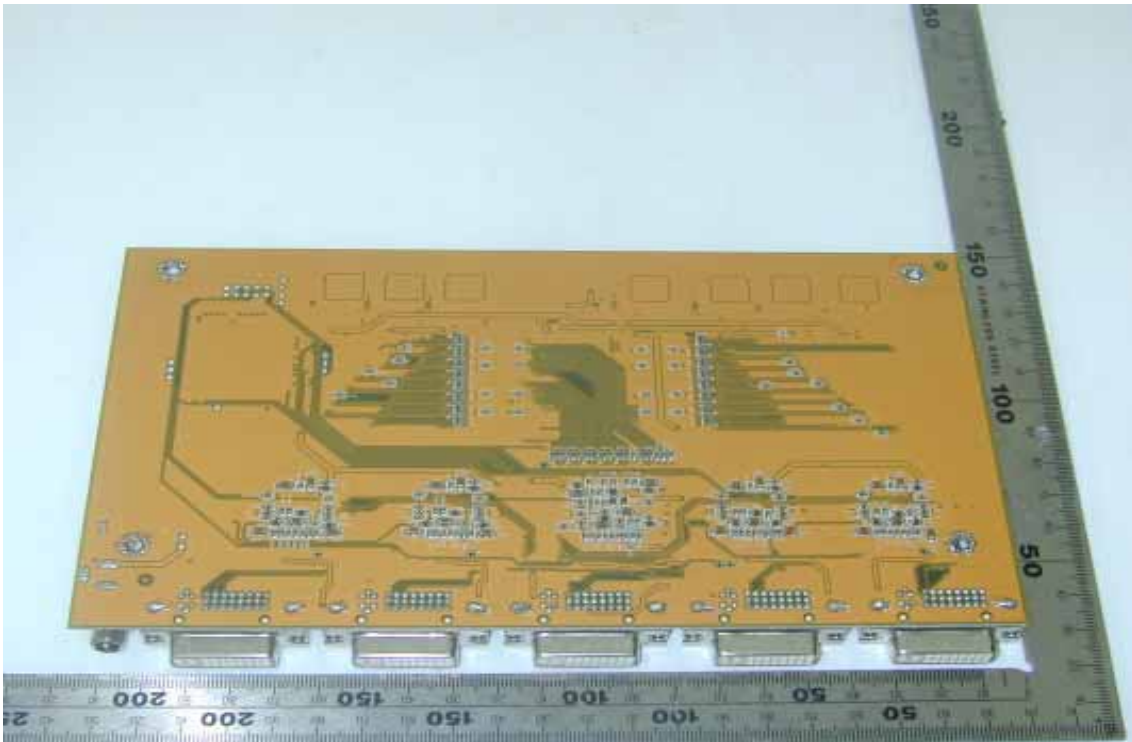

Solder Side of Main Board 1

PHOTO OF EUT

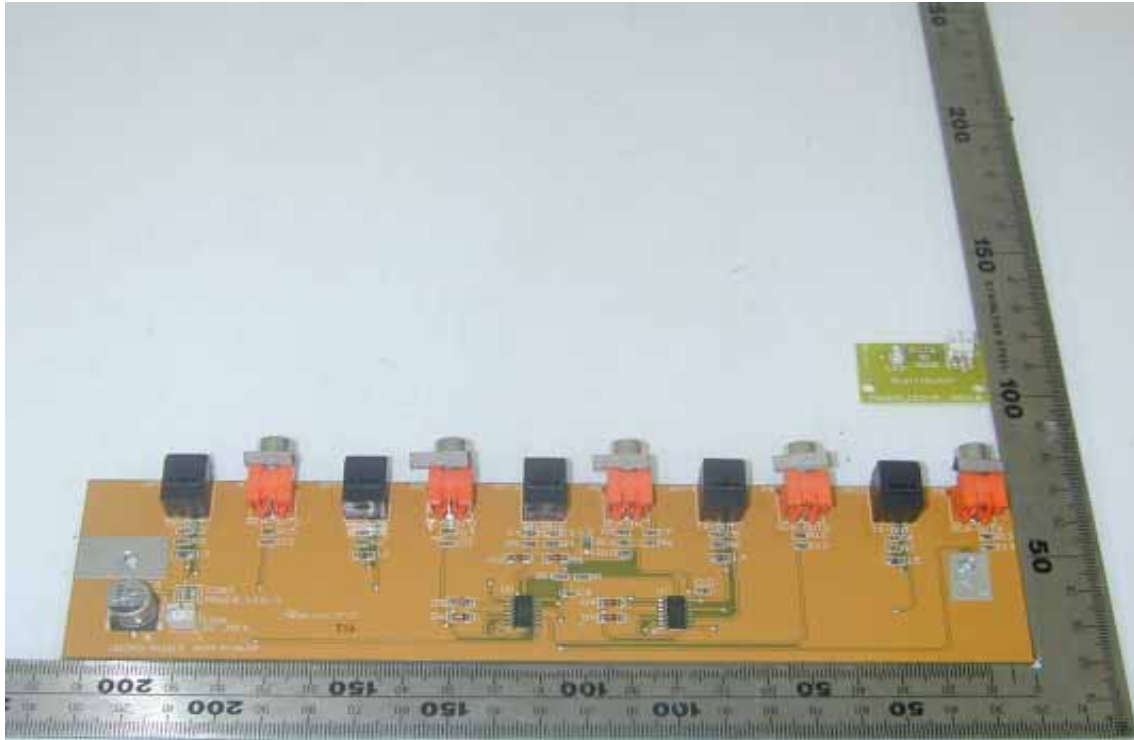

Component Side of Main Board 2

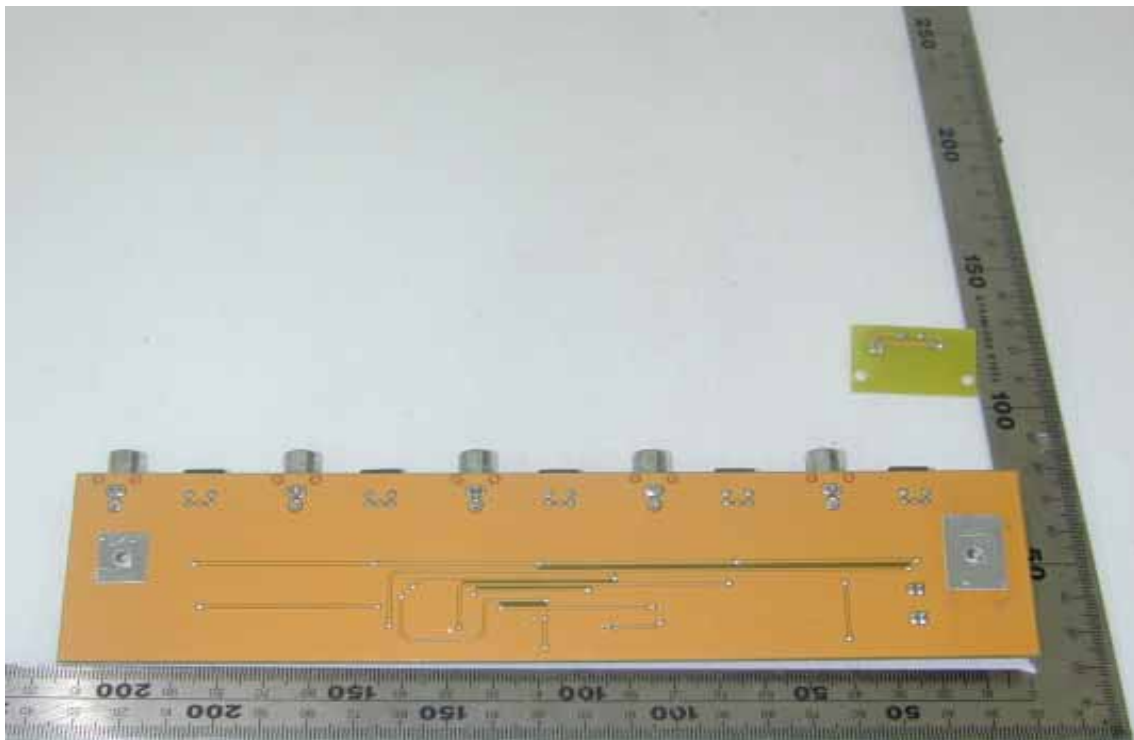

Solder Side of Main Board 2

PHOTO OF EUT



Front View of Adaptor



Rear View of Adaptor

Declaration of Conformity

Responsible Party Name :

Address :

Phone No :

Fax No :

Declares under our sole responsibility that the product

Product Name : Multimedia AV Distribution Amplifier

Model No. : DD04XXX

to which this declaration relates is in conformity with the following standards or other normative documents

AS/NZS CISPR 22 (2006) : Electromagnetic Interference
– Limits and Methods of Measurement of Information Technology Equipment

Representative Person's Name : _____

Signature : _____

Date : _____

United States Department of Commerce
National Institute of Standards and Technology

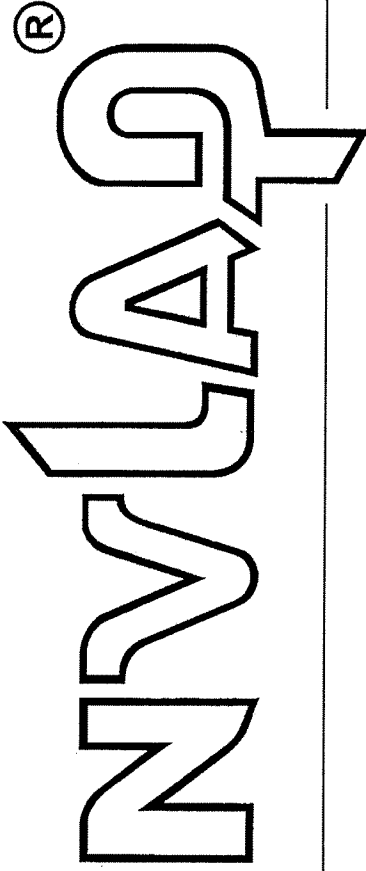

Certificate of Accreditation to ISO/IEC 17025:2005

NVLAP LAB CODE: 200331-0

HomeTek Technology Inc.

Taipei Shien 236

TAIWAN

is accredited by the National Voluntary Laboratory Accreditation Program for specific services,
listed on the Scope of Accreditation, for:

ELECTROMAGNETIC COMPATIBILITY AND TELECOMMUNICATIONS

*This laboratory is accredited in accordance with the recognized International Standard ISO/IEC 17025:2005.
This accreditation demonstrates technical competence for a defined scope and the operation of a laboratory quality
management system (refer to joint ISO-ILAC-IAF Communique dated 18 June 2005).*

2007-10-01 through 2008-09-30

Effective dates



Jolly S. Buce

For the National Institute of Standards and Technology



SCOPE OF ACCREDITATION TO ISO/IEC 17025:2005

HomeTek Technology Inc.

P.O Box: 13-131, Pan-Chiao City
No. 67-9 Shir Men Rd., Tu Chen City
Taipei Shien 236
TAIWAN

Mr. Grant Huang

Phone: 886-2-22608375 Fax: 886-2-22748013

E-Mail: hometek@ms15.hinet.net

**ELECTROMAGNETIC COMPATIBILITY
AND TELECOMMUNICATIONS**

NVLAP LAB CODE 200331-0

NVLAP Code Designation / Description

Emissions Test Methods:

12/CIS14a	EN 55014-1 (1993), A1 (1997), A2 (1999):
12/CIS14a2	BS EN 55014-1 (2001) with A1 and A2: Electromagnetic compatibility - Requirements for household appliances, electric tools and similar apparatus - Part 1: Emission
12/CIS14b1	AS/NZS CISPR 14-1 (2003): Electromagnetic Compatibility - Requirements for household appliances, electric tools and similar apparatus - Part 1: Emission
12/CIS14c	CNS 13783-1: Electromagnetic Compatibility Requirements for household appliances, electric tools and similar apparatus - Part 1: Emissions
12/CIS14d	IEC/CISPR 14-1 (2001) and A1 (2001): Electromagnetic Compatibility - Requirements for household appliances, electric tools and similar apparatus - Part 1: Emissions
12/CIS14x	IEC/CISPR 14-1, Ed. 4 (2003): Electromagnetic Compatibility - Requirements for household appliances, electric tools and similar apparatus - Part 1: Emission
12/CIS22	IEC/CISPR 22 (1997) & EN 55022 (1998) + A1(2000): Limits and methods of measurement of radio disturbance characteristics of information technology equipment

2007-10-01 through 2008-09-30

Effective dates

For the National Institute of Standards and Technology



National Voluntary Laboratory Accreditation Program



ELECTROMAGNETIC COMPATIBILITY AND TELECOMMUNICATIONS

NVLAP LAB CODE 200331-0

<i>NVLAP Code</i>	<i>Designation / Description</i>
12/CIS22a	IEC/CISPR 22 (1993) and EN 55022 (1994): Limits and methods of measurement of radio disturbance characteristics of information technology equipment, Amendment 1 (1995) and Amendment 2 (1996)
12/CIS22b	CNS 13438 (1997): Limits and Methods of Measurement of Radio Interference Characteristics of Information Technology Equipment
12/CIS22c	IEC/CISPR 22, Fourth Edition (2003-04) & EN 55022 (1998): Information technology equipment - Radio disturbance characteristics - Limits and methods of measurement
12/FCC15b	ANSI C63.4 (2003) with FCC Method 47 CFR Part 15, Subpart B: Unintentional Radiators
12/T51a	AS/NZS CISPR 22 (2004): Information technology equipment - Radio disturbance characteristics - Limits and methods of measurement
12/VCCIa	VCCI: Agreement of Voluntary Control Council for Interference by Information Technology Equipment - Technical Requirements: V-3/2005.04

2007-10-01 through 2008-09-30

Effective dates

For the National Institute of Standards and Technology