

HomeTek Technology Inc.

ADDRESS: No. 67-9, Shir Men Road, Tu Cheng City,  
Taipei Hsien, Taiwan

PHONE : 886-2-22608375 FAX : 886-2-22748013

E - mail : hometek@ms15.hinet.net

## FCC TEST REPORT FOR

APPLICANT : Smart Home Engineering Corp.  
ADDRESS : 10F., No. 493, Chung-Cheng Rd.,  
Hsin-Tien City, Taipei 231, Taiwan, R. O. C.  
EUT : Multimedia AV Distribution Amplifier  
MODEL NO. : DD0XXX

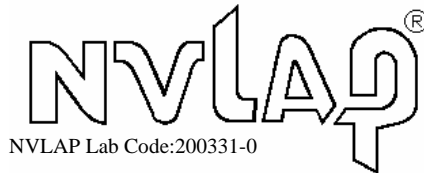

Accredited by the National Voluntary Laboratory Accreditation Program  
for the specific scope of accreditation under Lab Code 200331-0

MEASUREMENT PROCEDURE USED

FCC RULES AND CISPR 22-1997 AND FCC / ANSI C63.4-2003

PREPARED BY :

HomeTek Technology Inc.

No. 67-9, Shir Men Road, Tu Cheng City,

Taipei Hsien. Taiwan

Report # : FD6K005



**TABLE OF CONTENTS..... 2**

**CERTIFICATION..... 3**

**GENERAL INFORMATION..... 4**

**MODIFICATION LIST..... 6**

**CONDUCTED POWER LINE TEST ..... 7**

1 TEST INSTRUMENTS & FACILITIES ..... 7

2 TEST PROCEDURE ..... 7

3 TEST SETUP..... 8

4 CONFIGURATION OF THE EUT ..... 10

5 EUT OPERATING CONDITION ..... 14

6 LIMIT OF CONDUCTED POWER LINE EMISSION CLASS B ..... 14

7 RESULT OF CONDUCTED POWER LINE TEST ..... 14

8 CONDUCTED POWER LINE TEST DATA (PAGE 1) ..... 15

9 CONDUCTED POWER LINE TEST DATA (PAGE 2) ..... 16

10 CONDUCTED POWER LINE TEST DATA (PAGE 3) ..... 17

11 CONDUCTED POWER LINE TEST DATA (PAGE 4) ..... 18

**RADIATED EMISSION TEST..... 19**

1 TEST INSTRUMENTS & FACILITIES ..... 19

2 TEST PROCEDURE ..... 20

3 TEST SETUP..... 20

4 CONFIGURATION OF THE EUT ..... 22

5 EUT OPERATING CONDITION ..... 22

6 LIMIT OF RADIATED EMISSION CLASS B ..... 22

7 RESULT OF RADIATED EMISSION TEST ..... 23

8 RADIATED EMISSION TEST DATA (PAGE 1) ..... 24

9 RADIATED EMISSION TEST DATA (PAGE 2) ..... 25

**SAMPLE OF FCC DOC LABEL 1 ..... 26**

**SAMPLE OF FCC DOC LABEL 2 ..... 26**

**APPENDIX A**

PHOTOS OF TEST CONFIGURATION

**APPENDIX B**

PHOTOS OF EUT

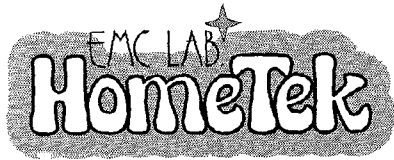

HomeTek Technology Inc.

ADDRESS: No. 67-9, Shir Men Road, Tu Cheng City,  
Taipei Hsien, Taiwan  
PHONE : 886-2-22608375 FAX : 886-2-22748013  
E - mail : hometek@ms15.hinet.net

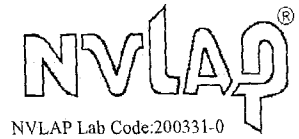

# CERTIFICATION

for  
FCC Part 15, Subpart B Class B

APPLICANT : Smart Home Engineering Corp.  
ADDRESS : 10F., No. 493, Chung-Cheng Rd.,  
Hsin-Tien City, Taipei 231, Taiwan, R. O. C.  
Receipt Date : 11/13/2007 Final Test Date: 11/20/2007  
EUT : Multimedia AV Distribution Amplifier  
MODEL NO. : DD0XXX

MEASUREMENT PROCEDURE USED :

PART 15 SUBPART B FCC RULES AND CISPR 22-1997  
AND FCC / ANSI C63.4-2003

TEST PROCEDURE AND DATA ARE TRACEABLE TO NIST/USA,  
TL or NML/TAIWAN.

- THE MAXIMUM EMISSION LEVELS WERE COMPARED TO THE CISPR 22 CLASS B LIMITS BOTH RADIATED AND CONDUCTED EMISSION.
- THE ABOVE DEVICE WAS TESTED BY HOMETEK TECHNOLOGY INC. TO SHOWS THE MAXIMUM EMISSION LEVEL FROM THE DEVICE.
- THIS TEST RESULTS OF THIS REPORT APPLIES TO ABOVE TESTED SAMPLE ONLY.
- THIS TEST REPORT SHALL NOT BE REPRODUCE IN PART WITHOUT WRITTEN APPROVAL OF HOMETEK TECHNOLOGY INC.
- THE REPORT MUST NOT BE USED BY THE CLIENT TO CLAIM PRODUCT ENDORSEMENT BY NVLAP, NIST OR ANY AGENCY OF THE U. S. GOVERNMENT.
- THE TEST RESULTS ARE TRACEABLE TO THE NATIONAL OR INTERNATIONAL STANDARD.

APPROVED BY : 

ALAIN LIN / Assistant Manage

**GENERAL INFORMATION**

- 1 APPLICANT : Smart Home Engineering Corp.
- 2 ADDRESS : 10F., No. 493, Chung-Cheng Rd.,  
Hsin-Tien City, Taipei 231, Taiwan, R. O. C.
- 3 MANUFACTURER : Smart Home Engineering Corp.
- 4 ADDRESS : 10F., No. 493, Chung-Cheng Rd.,  
Hsin-Tien City, Taipei 231, Taiwan, R. O. C.
- 5 DESCRIPTION OF EUT :
- EUT : Multimedia AV Distribution Amplifier
- FCC ID : N/A
- Model Number : DD0XXX
- Serial # : N/A

5.1 The difference between series of models DD04XXX are as shown below:

- (1) The first “X” represents different system input.
- (2) The second “X” represent different accessory.
- (3) The third “X” represent different color.

The PCB layout is similar. The worst case of EMI test data were shown in this test report.

## 6 FEATURES OF EUT :

**Please refer to user manual or product specification.**

## 7 TEST MODE :

The EUT were investigated with tree resolution modes shown as below :

- (1) 1920 x 1200 Mode;
- (2) 1280 x 1024 Mode;
- (3) 800 x 600 Mode

The test mode of (1) 1920 x 1200 Mode is worst case, and the final test data were shown in this test report.



## **MODIFICATION LIST**

THE FOLLOWING ACCESSORIES WERE ADDED TO THE EUT DURING TESTING :

NO MODIFICATION BY HOMETEK TECHNOLOGY INC.

## CONDUCTED POWER LINE TEST

### 1 TEST INSTRUMENTS & FACILITIES

The following test Instruments was used during the conducted test :

Item	Instruments/ Facilities	Specification	Manufacturer	Model # S/N	Date Of Cal.
1	EMI Receiver	9KHz ~ 30MHz	ROHDE & SCHWARZ	ESHS 30 844827/007	FEB/2007
2	LISN (for EUT)	50Ω/50uH/100A 150KHz ~ 30MHz	SCHWARZ BECK	NNLK 8121 8121370	OCT/2007
3	LISN (for Support Unit)	50Ω/50uH/10A 9KHz ~ 30MHz	ROHDE & SCHWARZ	ESH3-Z5 846128/007	MAR/2007
4	Terminator	50Ω	N/A	N/A	NOV/2007
5	Attenuation	50Ω/10dB	Mini-Circuit	NAT-10 AT-002	JUL/2007
6	Cable	5.4m	SUHNER	RG-223 CON2-002	AUG/2007
7	ESXS-K1 (software)	Version 2.03b 9KHz ~ 30MHz	ROHDE & SCHWARZ	1082.9678.02 840.913/246	N/A

Note : Items 1 ~ 6 were calibrated within period of 1 year.

### 2 TEST PROCEDURE

- 2.1 The EUT was tested according to **ANSI C63.4 – 2003 Section 5.2, 7.1, 7.2 & CISPR 22 - 1997 & C18-01-12 (HomeTek test procedure)**.
- 2.2 The EUT was placed 0.4 meter from the conducting wall of shielding room and kept at least 0.8 meter from any other grounded conducting surface.
- 2.3 The frequency range form 0.15 MHz to 30 MHz was investigated.
- 2.4 The LISN used was 50 Ohm / 50 uHenry as specified by Section 4.1.2 of **ANSI C63.4 - 2003**.
- 2.5 All the support peripherals are connect to the other LISN.
- 2.6 Cables and peripherals were moved to find the maximum emission levels for each frequency.

### 3 TEST SETUP

#### 3.1 Typical : Setup Of Conducted Test

ELECTRICAL AND ELECTRONIC EQUIPMENT IN THE RANGE OF 9kHz TO 40 GHz

ANSI  
C63.4-2003

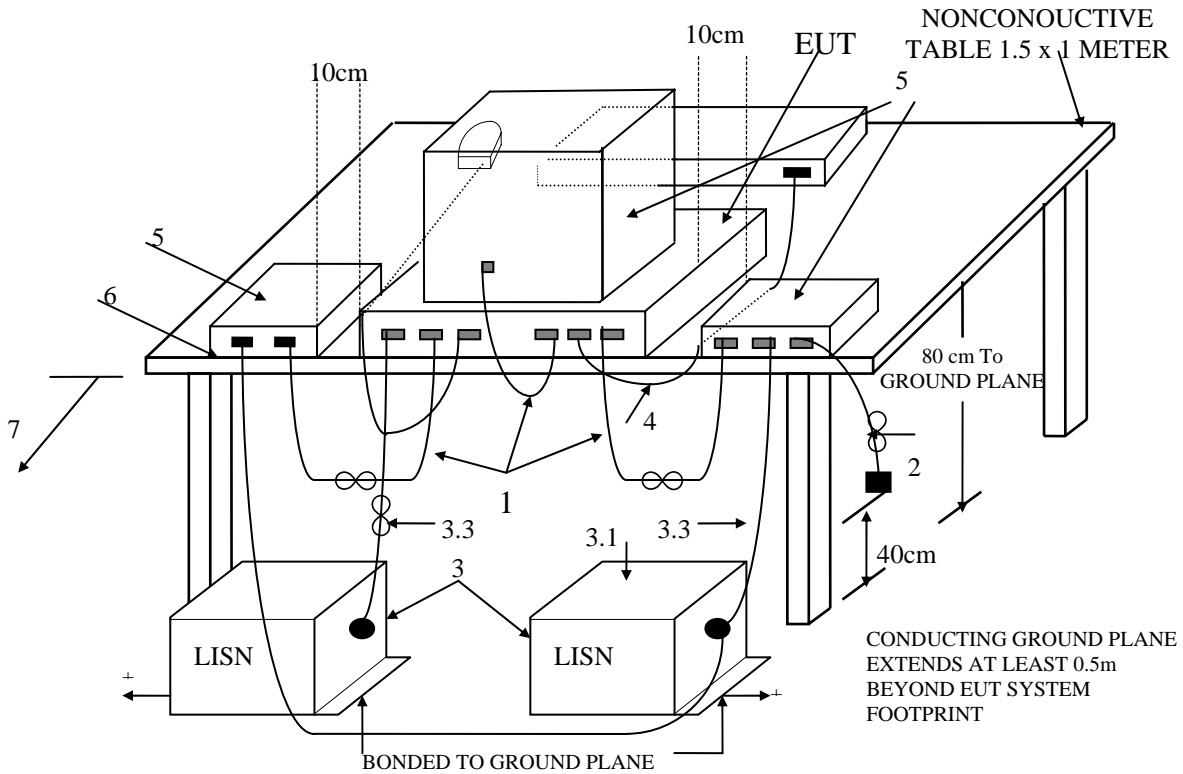

+LISNs may have to be moved to the side to meet 3.3 below.

(Details for setup configuration, please refer to appendix A.)

#### LEGEND:

1. Interconnecting cables that hang closer than 40 cm to the ground plane shall be folded back and forth forming a bundle 30 to 40 cm long, hanging approximately in the middle between ground plane and table.
2. I/O cables that are connected to a peripheral shall be bundled in center. The end of the cable may be terminated if required using correct terminating impedance. The total length shall not exceed 1m.
3. EUT connected to one LISN. Unused LISN connectors shall be terminated in 50 Ω. LISN can be placed on top of, or immediately beneath, ground plane.
  - 3.1 All other equipment powered from second LISN.
  - 3.2 Multiple outlet strip can be used for multiple power cords of non-EUT equipment.
  - 3.3 LISN at least 80 cm from nearest part of EUT chassis.
4. Cables of hand-operated devices, such as keyboards, mice, etc., have to be placed as close as possible to the host.
5. Non-EUT components being tested.
6. Rear of EUT, including peripherals, shall be all aligned and flush with rear of tabletop.
7. Rear of tabletop shall be 40 cm removed from a vertical conducting plane that is bonded to the floor ground plane (see 5.2).

#### **Test Configuration Tabletop Equipment Conducted Emission**

## 3.2 Block Diagram Of Conducted Test

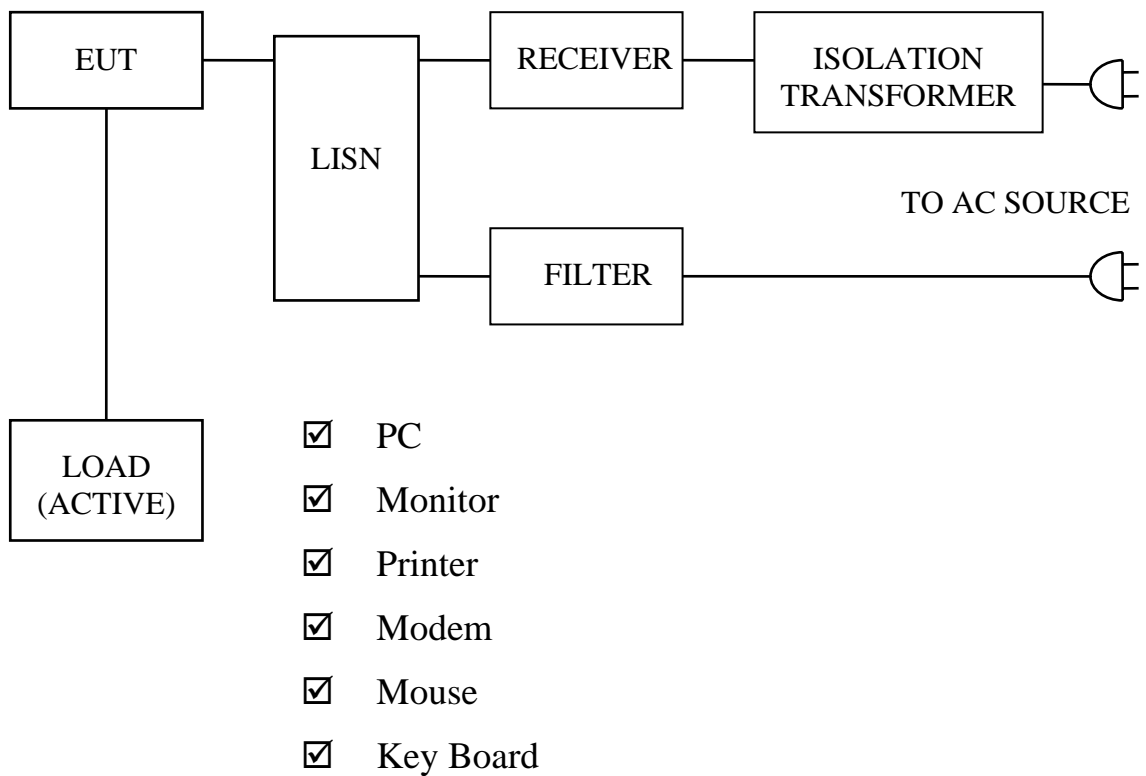



#### 4 CONFIGURATION OF THE EUT

The EUT was configured according to **ANSI C63.4 - 2003 & CISPR 22 - 1997**. All I/O ports were connected to the appropriate peripherals. All peripherals and cables are listed below (including internal device) :

##### 4.1 EUT

EUT Type : Proto Type Engineer Type Mass Production  
Condition when received : Good Damage : \_\_\_\_\_  
Device : Multimedia AV Distribution Amplifier  
Applicant : Smart Home Engineering Corp.  
Manufacturer : Smart Home Engineering Corp.  
Model Number : DD0XXX  
Serial Number : N/A  
FCC ID : N/A  
DVI IN Port : Metal Type Connector  
DVI OUT Port : Metal Type Connector  
DVI OUT Cable Floating x 3 : Shielded, 2 m, Metal Type Connector  
Coaxial Port Cable Floating x 5 : Shielded, 1.5 m, Metal Type Connector  
Optical Port Cable Floating x 5 : Metal Type Connector  
Power Cord (AC) : 2 pin  
Power Cord (DC) : Un-Shielded, 1.8 m, 2 pin  
Power Supply Type : Switching Power Adapter



#### 4.2 PERIPHERALS

Host Personal Computer

Manufacturer : HP/COMPAQ  
Model Number : D330UT  
Serial Number : SGH40606Z1  
FCC ID : FCC DoC  
Data Cable : Shielded, 1.8 m, Connect to the DVI IN Port  
Power Cord : Un-Shielded, 1.8 m

Monitor

Manufacturer : BENQ  
Model Number : FP241W  
Serial Number : ETLA607230CLO  
FCC ID : FCC DoC  
Data Cable : Shielded, 1.8 m, Connected to the DVI OUT port  
Power Cord : Un-Shielded, 1.8 m

Printer

Manufacturer : HP  
Model Number : DJ400  
Serial Number : MY77T1D0DD  
FCC ID : B94C2642X  
Data Cable : Shielded, 1.5 m, Connected to the Printer port  
Power Cord & Adaptor : Un-Shielded, 1.8 m



Modem

Manufacturer : ACEEX  
Model Number : 1414  
Serial Number : 9013522  
FCC ID : IFAXDM1414  
Data Cable : Shielded, 1.5 m, Connected to the COM port  
Power Cord & Adaptor : Un-Shielded, 1.8 m

Mouse (PSII)

Manufacturer : HP  
Model Number : M-S69  
Serial Number : 334684-002  
FCC ID : FCC DoC  
Data Cable : Shielded, 1.8 m, Connected to the PSII port  
Power Cord : N/A

KeyBoard (PSII)

Manufacturer : HP  
Model Number : KB-0133  
Serial Number : 323686-AB1  
FCC ID : FCC DoC  
Data Cable : Shielded, 1.5 m, Connected to the PSII port  
Power Cord : N/A



Power Adapter

Manufacturer : ELEC

Model Number : ADP051200R-1

Serial Number : N/A

FCC ID : N/A

Data Cable : N/A

Power Cord (DC) : Un-Shielded, 1.8 m

4.3 REMARK : N/A

## 5 EUT OPERATING CONDITION

- 5.1 The frequency of the EUT is none.
- 5.2 Configure the EUT according to the **ANSI C63.4 - 2003 & CISPR 22 - 1997**.
- 5.3 The test configuration included PC, Keyboard, Mouse, Printer and Modem.
- 5.4 Turn on all the power of EUT and peripheral.
- 5.5 PC sends data signal (resolutions: 1920 x 1200 / 1280 x 1024 / 800x 600) to Monitor via EUT's DVI port.
- 5.6 During the test, the PC sends "H" patterns to each I/O port individually. EUT display "H" character.
- 5.7 Adjust the location of EUT and peripheral to gain the maximum EMI noise.
- 5.8 The photos of conducted test configuration, please refer to appendix A.**

## 6 LIMIT OF CONDUCTED POWER LINE EMISSION CLASS B

Frequency Range	Quasi Peak	Average
0.15 ~ 0.5 MHz	66 - 56 dBuV	56 - 46 dBuV
0.5 ~ 5 MHz	56 dBuV	46 dBuV
5 ~ 30 MHz	60 dBuV	50 dBuV

- 6.1 In the above table, the tighter limit applies at the band edges.

## 7 RESULT OF CONDUCTED POWER LINE TEST

- 7.1 The frequency range from 0.15 MHz to 30 MHz was investigated. All readings are quasi-peak values and average.
- 7.2 IF bandwidth : 9 kHz, Meas Time : 1 sec.
- 7.3 Temperature : 26 °C, Humidity : 55 % RH.
- 7.4 Deviations from the test standards and rules : None
- 7.5 The conducted test result were gained by following procedures :  
 Level = Reading Level + Insertion Loss of LISN + Cable Loss  
 (All calculation were done by ESHS30 EMI test receiver.)
- 7.6 Result : **PASSED**

## 8 CONDUCTED POWER LINE TEST DATA (PAGE 1)

HomeTek EMC LAB. TEL :886-2-22608375

12 Nov 2007 11:04

### CONDUCTED EMISSIONS

EUT: Multimedia AV Distribution Amplifier  
 Manuf: 6k005  
 Op Cond: LINE 1  
 Operator: alain  
 Test Spec: FOR CISPR 22 CLASS B  
 Comment: AC110V 60Hz  
 DD040D 1920x1200  
 Result File: 6k00511b.dat :

Prescan Measurement: Detectors: X PK / + AV  
 Meas Time: see scan settings  
 Subranges: 16  
 Acc Margin: 55 dB

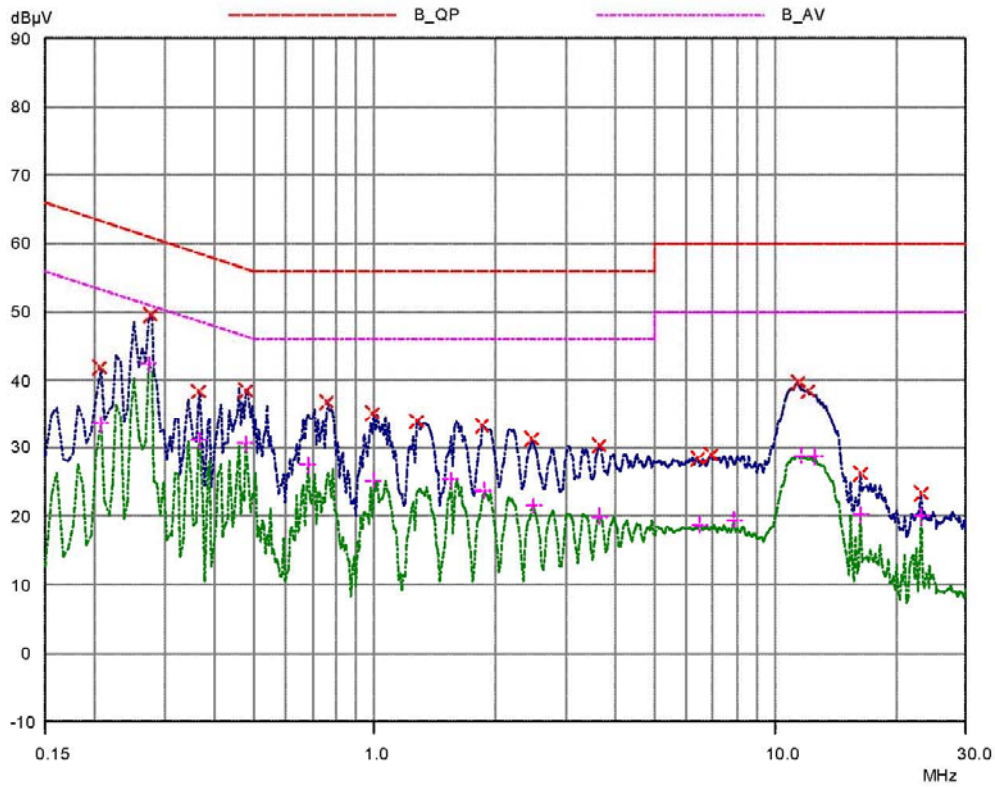



### 9 CONDUCTED POWER LINE TEST DATA (PAGE 2)

HomeTek EMC LAB. TEL :886-2-22608375

12 Nov 2007 11:04

#### CONDUCTED EMISSIONS

EUT: Multimedia AV Distribution Amplifier  
 Manuf: 6k005  
 Op Cond: LINE 1  
 Operator: alain  
 Test Spec: FOR CISPR 22 CLASS B  
 Comment: AC110V 60Hz  
 DD040D 1920x1200  
 Result File: 6k00511b.dat :

Prescan Measurement: Detectors: X PK / + AV  
 Meas Time: see scan settings  
 Subranges: 16  
 Acc Margin: 55 dB

#### Peak Search Results

Frequency MHz	PK Level dBµV	PK Limit dBµV	PK Delta dB
0.205	41.76	63.41	21.65
0.275	49.46	60.97	11.51
0.365	38.37	58.61	20.24
0.48	38.59	56.34	17.75
0.76	36.83	56.00	19.17
0.989	35.18	56.00	20.82
1.283	34.00	56.00	22.00
1.857	33.23	56.00	22.77
2.459	31.23	56.00	24.77
3.628	30.32	56.00	25.68
6.37	28.46	60.00	31.54
8.89	28.96	60.00	31.04
11.41	39.64	60.00	20.36
12.04	38.60	60.00	21.40
16.29	26.14	60.00	33.86
23.13	23.27	60.00	36.73

Frequency MHz	AV Level dBµV	AV Limit dBµV	AV Delta dB
0.205	33.54	53.41	19.87
0.27	42.35	51.12	8.77
0.365	31.05	48.61	17.56
0.475	30.58	46.43	15.85
0.68	27.51	46.00	18.49
0.989	25.24	46.00	20.76
1.549	25.38	46.00	20.62
1.864	23.76	46.00	22.24
2.487	21.55	46.00	24.45
3.614	19.98	46.00	26.02
6.46	18.78	50.00	31.22
7.85	19.45	50.00	30.55
11.64	28.82	50.00	21.18
12.55	28.73	50.00	21.27
16.29	20.29	50.00	29.71
23.13	20.05	50.00	29.95

\* limit exceeded

### 10 CONDUCTED POWER LINE TEST DATA (PAGE 3)

HomeTek EMC LAB. TEL :886-2-22608375

12 Nov 2007 11:14

**CONDUCTED EMISSIONS**

EUT: Multimedia AV Distribution Amplifier  
 Manuf: 6K005  
 Op Cond: LINE 2  
 Operator: alain  
 Test Spec: FOR CISPR 22 CLASS B  
 Comment: AC110V 60Hz  
 DD040D 1920x1200  
 Result File: 6k00521b.dat :

Prescan Measurement: Detectors: X PK / + AV  
 Meas Time: see scan settings  
 Subranges: 16  
 Acc Margin: 55 dB

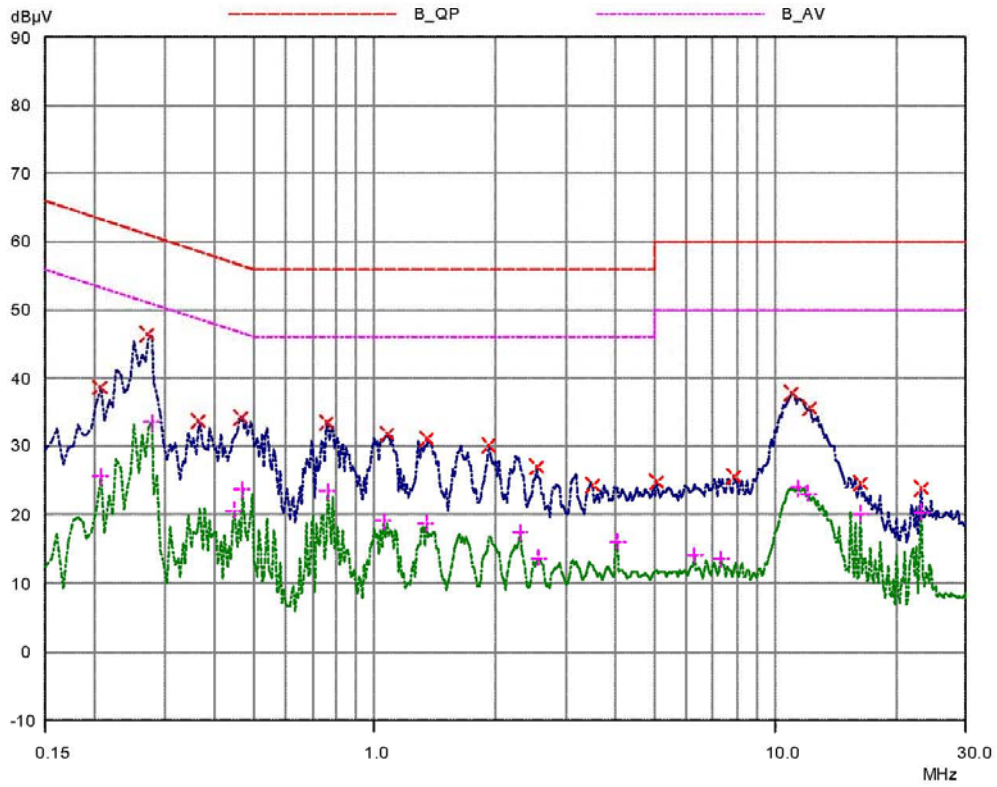



# 11 CONDUCTED POWER LINE TEST DATA (PAGE 4)

HomeTek EMC LAB. TEL :886-2-22608375

12 Nov 2007 11:14

## CONDUCTED EMISSIONS

EUT: Multimedia AV Distribution Amplifier  
 Manuf: 6K005  
 Op Cond: LINE 2  
 Operator: alain  
 Test Spec: FOR CISPR 22 CLASS B  
 Comment: AC110V 60Hz  
 DD040D 1920x1200  
 Result File: 6k00521b.dat :

Prescan Measurement: Detectors: X PK / + AV  
 Meas Time: see scan settings  
 Subranges: 16  
 Acc Margin: 55 dB

### Peak Search Results

Frequency MHz	PK Level dBµV	PK Limit dBµV	PK Delta dB
0.205	38.62	63.41	24.79
0.27	46.43	61.12	14.69
0.365	33.62	58.61	24.99
0.465	34.23	56.60	22.37
0.76	33.54	56.00	22.46
1.08	31.70	56.00	24.30
1.353	31.00	56.00	25.00
1.927	30.12	56.00	25.88
2.522	26.86	56.00	29.14
3.495	24.22	56.00	31.78
5.05	24.92	60.00	35.08
7.89	25.43	60.00	34.57
10.97	37.69	60.00	22.31
12.1	35.62	60.00	24.38
16.29	24.56	60.00	35.44
23.13	23.75	60.00	36.25

Frequency MHz	AV Level dBµV	AV Limit dBµV	AV Delta dB
0.205	25.58	53.41	27.83
0.275	33.48	50.97	17.49
0.445	20.68	46.97	26.29
0.465	23.69	46.60	22.91
0.76	23.38	46.00	22.62
1.04499	19.09	46.00	26.91
1.339	18.78	46.00	27.22
2.298	17.47	46.00	28.53
2.557	13.64	46.00	32.36
4.013	16.09	46.00	29.91
6.28	14.10	50.00	35.90
7.31	13.52	50.00	36.48
11.33	23.92	50.00	26.08
12.0	23.05	50.00	26.95
16.29	20.21	50.00	29.79
23.13	20.42	50.00	29.58

\* limit exceeded

## RADIATED EMISSION TEST

### 1 TEST INSTRUMENTS & FACILITIES

The following test Instruments was used during the radiated emission test :

Item	Instruments /facilities	Specification	Manufacturer	Model # / S/N#	Date of Cal.
1	OPEN AREA TEST SITE	<input checked="" type="checkbox"/> OATS 3			JUL/2007
2	EMI TEST RECEIVER	20Hz ~ 26.5GHz	ROHDE & SCHWARZ	ESMI 845442/006	FEB/2007
3	PRE-AMPLIFIER	9KHz ~ 3000MHz	ADVANTEST	BB525C 90081001	OCT/2007
4	ANTENNA (BI-LOG)	25MHz ~ 2GHz	SCHAFFNER	CBL6112B S/N : 2611	JUN/2007
5	Attenuation	50Ω/6dB	JYE BAO	FAT-N (M-F) 001	JUL/2007
6	Cable	10m	SUHNER	RG214/U OS3-003	DEC/2006
7	Cable	14m	BELDEN	9913 OS3-001	DEC/2006
8	EMI 32 (software)	N/A	AUDIX	19991013-0923	N/A

Note : Items 1 ~ 7 were calibrated within period of 1 year.

## 2 TEST PROCEDURE

- 2.1 The EUT was test according to **ANSI C63.4 – 2003 Section 5.4, 5.5, 8.1, 8.2, 8.3 & CISPR 22 - 1997 & C18-01-11 (HomeTek test procedure)**.
- 2.2 The radiated test was performed at HomeTek Lab's Open Site 3.
- 2.3 The frequency range from 30 MHz to 1 GHz, the measurement were made at 10 meters, with a BI-log antenna.

## 3 TEST SETUP

### 3.1 TEST SETUP OF OPEN SITE.

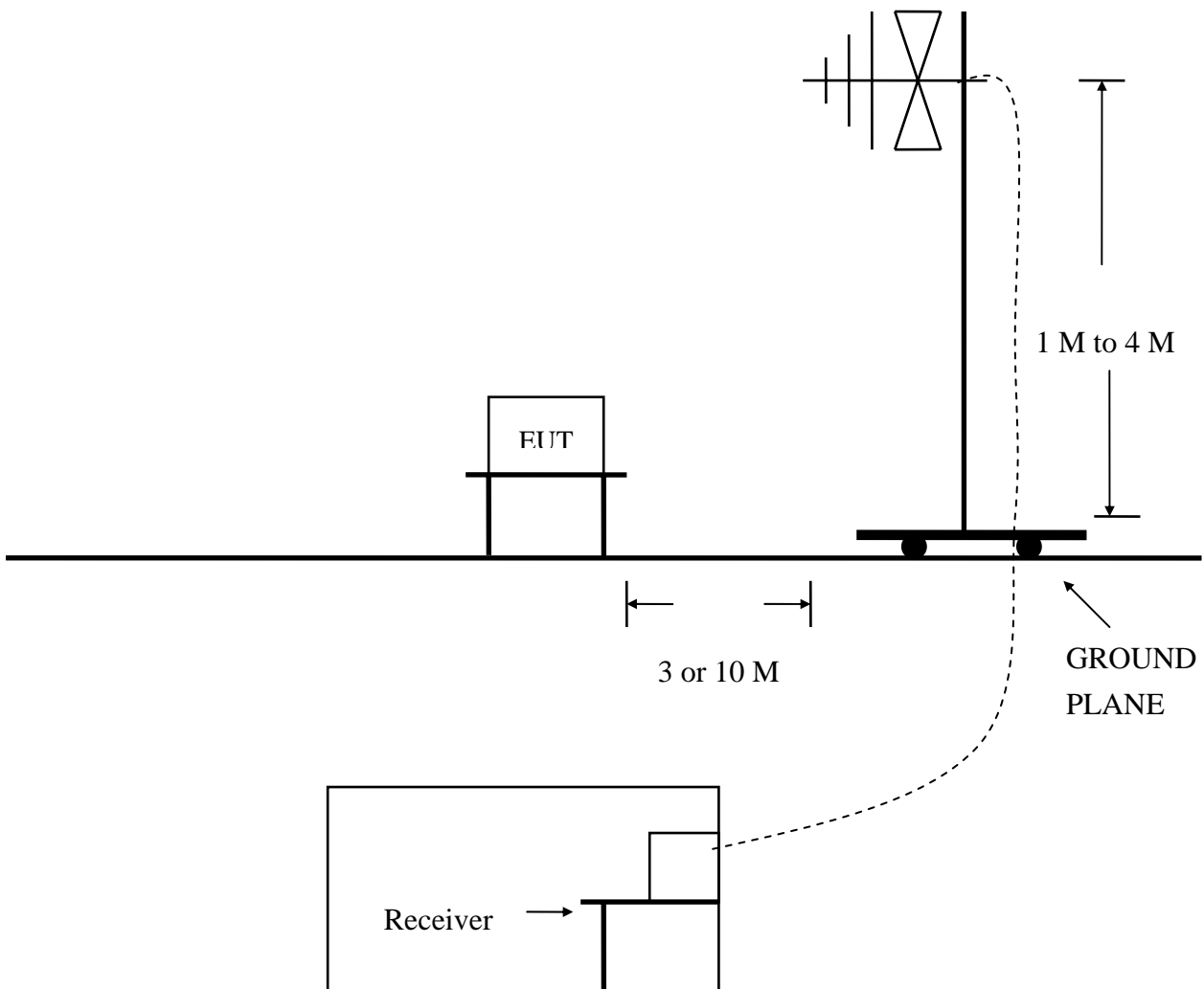

### 3.2 TEST SETUP OF EUT

ELECTRICAL AND ELECTRONIC EQUIPMENT IN THE RANGE OF 9kHz TO 40 GHz

ANSI  
C63.4-2003

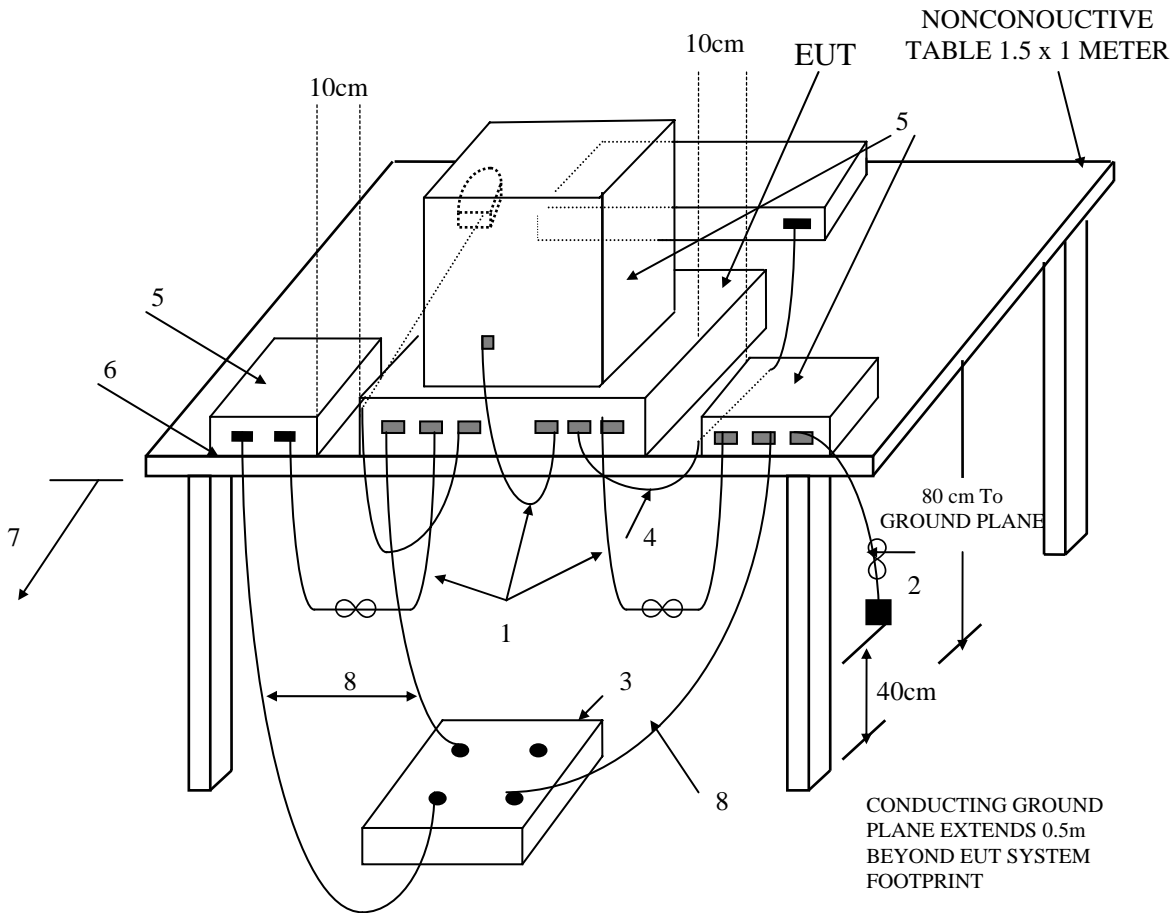

(Details for setup configuration, please refer to appendix A.)

**LEGEND:**

1. Interconnecting cables that hang closer than 40 cm to the ground plane shall be folded back and forth forming a bundle 30 to 40 cm long, hanging approximately in the middle between ground plane and table.
2. I/O cables that are connected to a peripheral shall be bundled in center. The end of the cable may be terminated if required using correct terminating impedance. The total length shall not exceed 1m.
3. If LISNs are kept in the test setup for radiated emissions, it is preferred that they be installed under the ground plane with the receptacle flush with the ground plane.
4. Cables of hand-operated devices, such as keyboards, mice, etc., have to be placed as close as possible to the controller.
5. Non-EUT components of EUT system being tested.
6. The rear of all components of the system under test shall be located flush with the rear of the table.
7. No vertical conducting wall used.
8. Power cords drape to the floor and are routed over to receptacle.

**Test Configuration  
Tabletop Equipment Radiated Emission**

4 CONFIGURATION OF THE EUT

Same as “Conducted Power Line test”, section 4

5 EUT OPERATING CONDITION

5.1 Same as “Conducted Power Line test”, section 5

5.2 The radiated emission in the frequency range from 30 MHz - 1000 MHz was test in a horizontal and vertical polarization at HomeTek Lab’s open site 3.

**5.3 The photos of radiated test configuration, please refer to appendix A.**

6 LIMIT OF RADIATED EMISSION CLASS B

CISPR 22

Frequency (MHz)	Measurement Distance	Limit (dBuV/m)
30 - 230	10 (M)	30
230 - 1000	10 (M)	37

6.1 The tighter limit shall apply at the edge between two frequency bands.

6.2 Measurement distance in meters between the measuring instrument antenna and the closed point of any part of the EUT or peripherals.

## 7 RESULT OF RADIATED EMISSION TEST

- 7.1 The frequency range from 30 MHz to 1 GHz was investigated.
- 7.2 All readings below or equal 1 GHz are quasi-peak or peak values with resolution bandwidth of 120 KHz.
- 7.3 All readings above 1 GHz are average or peak values with resolution bandwidth of 1 MHz
- 7.4 The measurements were made at 10 meters of HomeTek Lab's open site 3.
- 7.5 Temperature : 23 °C, Humidity : 56 % RH.
- 7.6 Deviation form the test standards and rules : None
- 7.7 The radiation emission result were gained by the following method :  
Level = Reading Level + Probe Factor (Antenna Factor) + Cable Loss – Preamp Factor  
Over Limit = Level – Limit Line
- 7.8 The radiated mission test was passed at minimum margin :  
Horizontal 321.05 MHz/ 33.76 dBuV/m, Antenna Height 3.2 Meter,  
Turn Table 125 degree, The Mode : DD04D, Model : 1920 x 1200 Mode.
- 7.9 Result : **PASSED**



# 8 RADIATED EMISSION TEST DATA (PAGE 1)



HomeTek Technology Inc.

No 67-9, Shi-Men Rd.;, Tu-Chen City,  
Taipei County, Taiwan R.O.C.  
Tel:02-22608375  
Fax:02-22748013

Data#: 1 File#: 6K005.EMI

Date: 2007-11-20 Time: 15:31:23

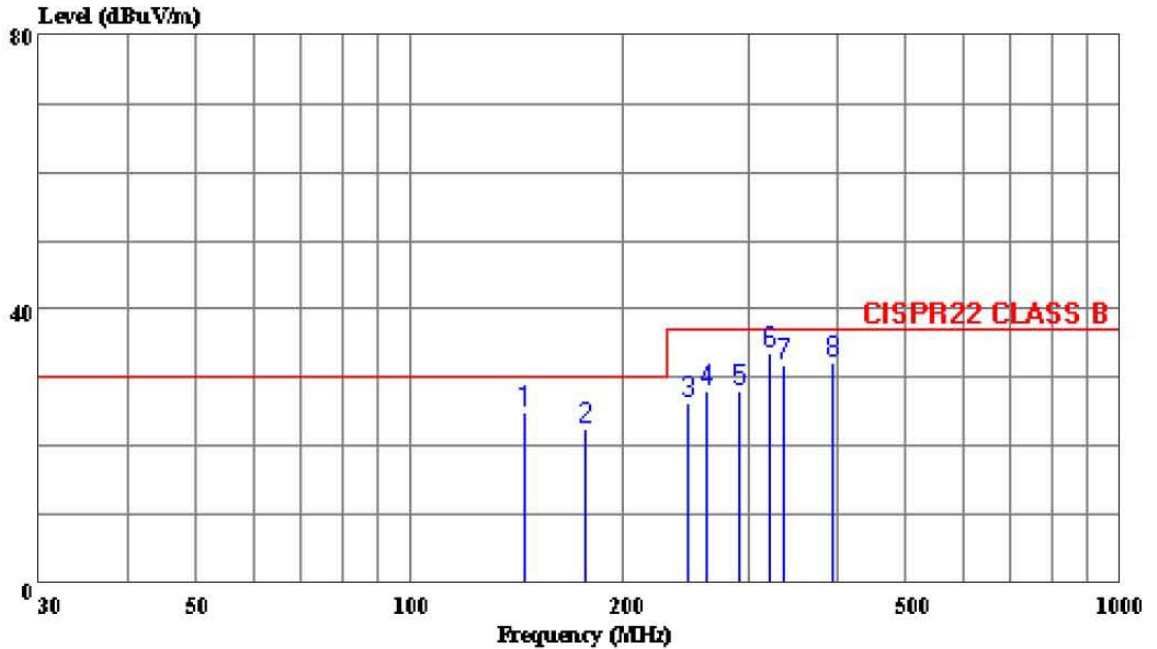

Trace:

Ref Trace:

Condition: CISPR22 CLASS B 10m CHASE 2611 070612 HORIZONTAL  
eut : Multimedia AV Distribution Amplifier  
power: 110V/60Hz  
memo : DD04D(1920\*1200)

Page: 1

	Freq	Level	Limit	Over	ReadAntenna	Cable	Preamp	
	MHz	dBuV/m	dBuV/m	Limit	Level	Loss	Factor	Remark
				dB	dBuV	dB	dB	
1	145.062	24.95	30.00	-5.05	38.02	10.94	1.81	25.81 Peak
2	176.008	22.44	30.00	-7.56	36.85	9.35	1.99	25.75 Peak
3	247.219	26.40	37.00	-10.60	37.26	12.30	2.45	25.61 Peak
4	261.200	27.90	37.00	-9.10	36.68	14.26	2.54	25.58 Peak
5	290.394	27.98	37.00	-9.02	37.69	13.10	2.71	25.52 Peak
6	321.059	33.76	37.00	-3.24	42.42	13.87	2.91	25.44 QP
7	335.616	31.81	37.00	-5.19	39.95	14.26	3.00	25.40 Peak
8	394.290	32.36	37.00	-4.64	38.58	15.68	3.32	25.23 Peak



9 RADIATED EMISSION TEST DATA (PAGE 2)



HomeTek Technology Inc.

No 67-9, Shi-Men Rd.;, Tu-Chen City, Taipei County, Taiwan R.O.C. Tel:02-22608375 Fax:02-22748013

Data#: 2 File#: 6K005.EMI Date: 2007-11-20 Time: 16:41:57

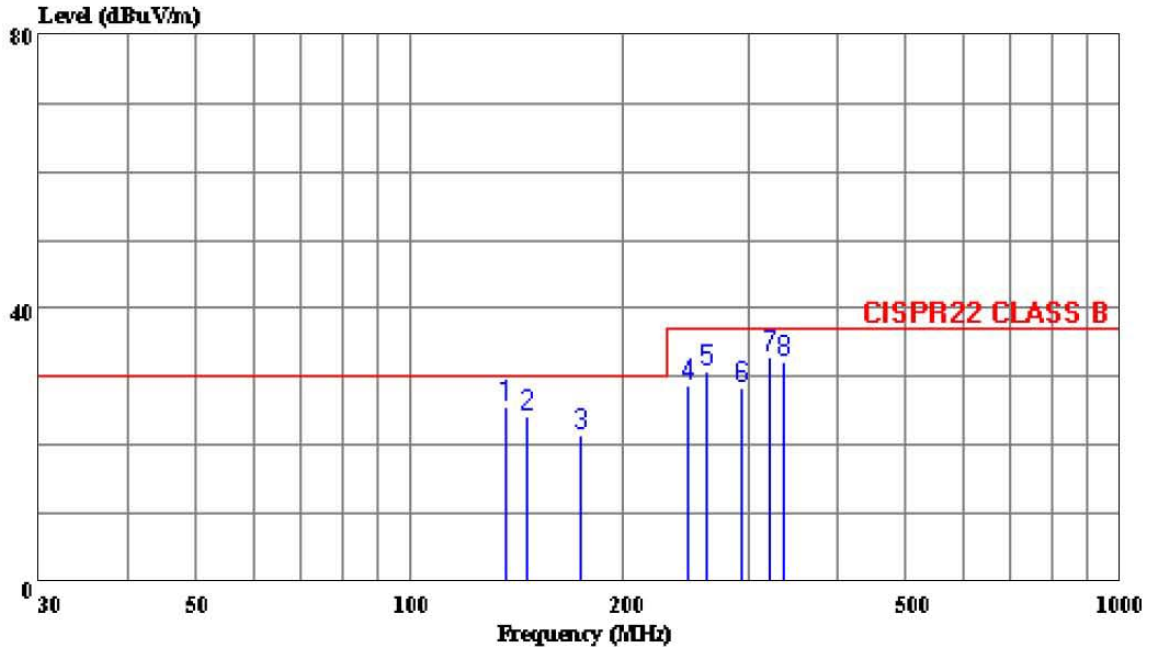

Trace:

Ref Trace:

Condition: CISPR22 CLASS B 10m CHASE 2611 070612 VERTICAL  
 eut : Multimedia AV Distribution Amplifier  
 power: 110V/60Hz  
 memo : DD04D(1920\*1200)

Page: 1

	Freq	Level	Limit	Over	ReadAntenna	Cable	Preamp	
	MHz	dBuV/m	dBuV/m	Limit	Level	Loss	Factor	Remark
				dB	dBuV	dB	dB	
1	136.940	25.73	30.00	-4.27	38.05	11.75	1.76	25.83 Peak
2	146.091	24.31	30.00	-5.69	37.49	10.82	1.81	25.81 Peak
3	174.029	21.55	30.00	-8.45	35.92	9.41	1.98	25.76 Peak
4	247.094	28.83	37.00	-8.17	39.69	12.30	2.45	25.61 Peak
5	261.029	30.91	37.00	-6.09	39.69	14.26	2.54	25.58 Peak
6	292.309	28.39	37.00	-8.61	38.03	13.16	2.72	25.51 Peak
7	321.091	33.02	37.00	-3.98	41.68	13.87	2.91	25.44 QP
8	335.092	32.09	37.00	-4.91	40.26	14.24	2.99	25.40 Peak

### **SAMPLE OF FCC DoC LABEL 1**

This device complies with part 15 of the FCC Rules.  
Operation is subject to the following two conditions: (1)  
This device may not cause harmful interference. And (2)  
this device must accept any interference received, including  
interference that may cause undesired operation.

### **SAMPLE OF FCC DoC LABEL 2**





HomeTek Technology Inc.

## **Appendix A**

# **PHOTOS OF TEST CONFIGURATION**

## PHOTO OF CONDUCTED POWER LINE TEST

Test Model : DD04D , Test Mode : 1920\*1200 Mode



Front View



Rear View

## PHOTO OF RADIATED EMISSION TEST

Test Model : DD04D , Test Mode : 1920\*1200 Mode



Front View



Rear View



HomeTek Technology Inc.

## **Appendix B**

### **PHOTOS OF EUT**

### PHOTO OF EUT



Front View of EUT



Rear View of EUT

### PHOTO OF EUT



Inside View of EUT



Case Inside View of EUT

## PHOTO OF EUT

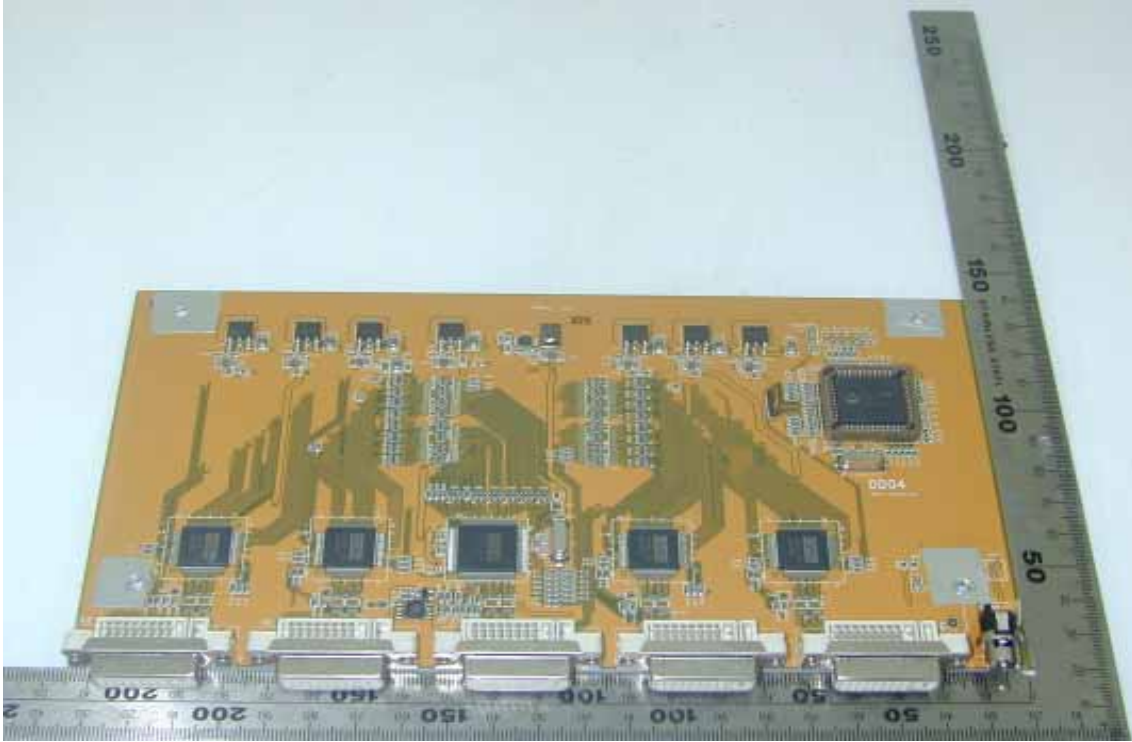

Component Side of Main Board 1

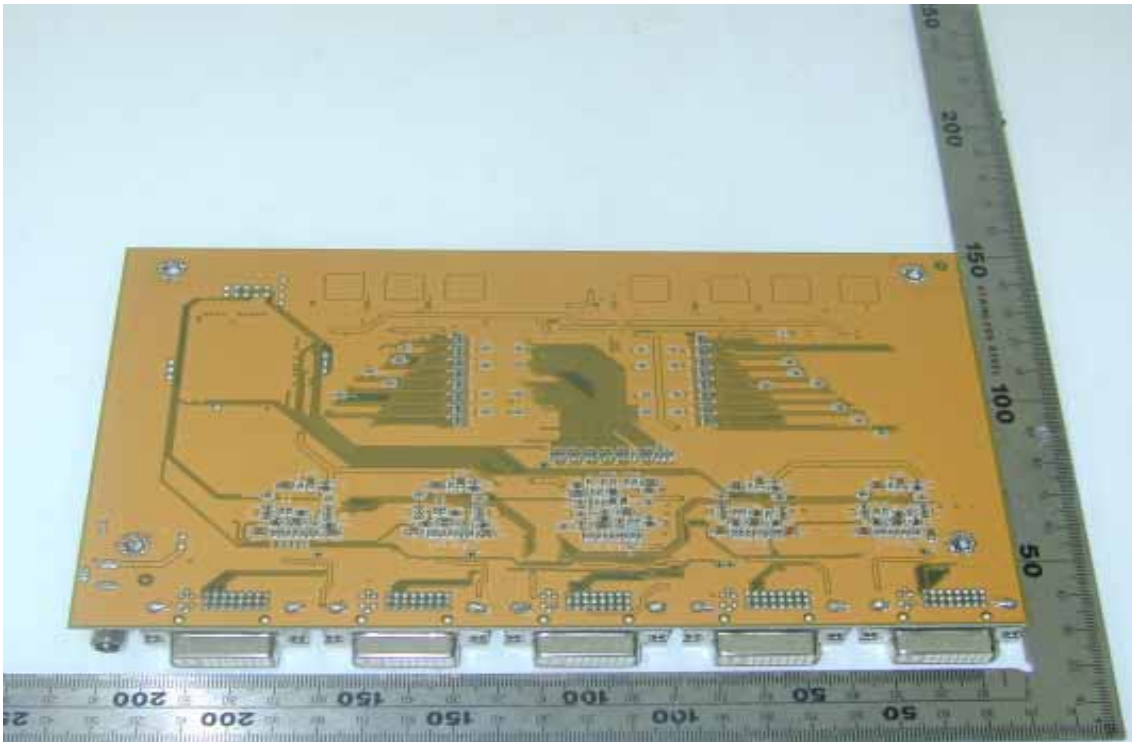

Solder Side of Main Board 1

### PHOTO OF EUT

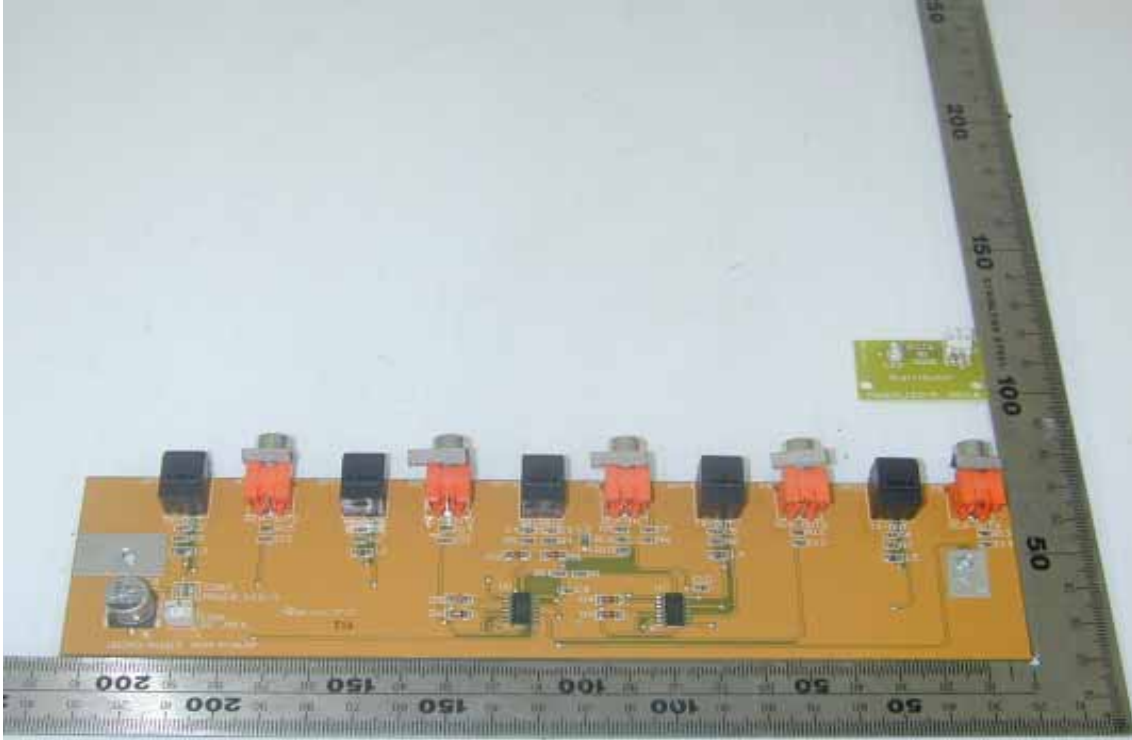

Component Side of Main Board 2

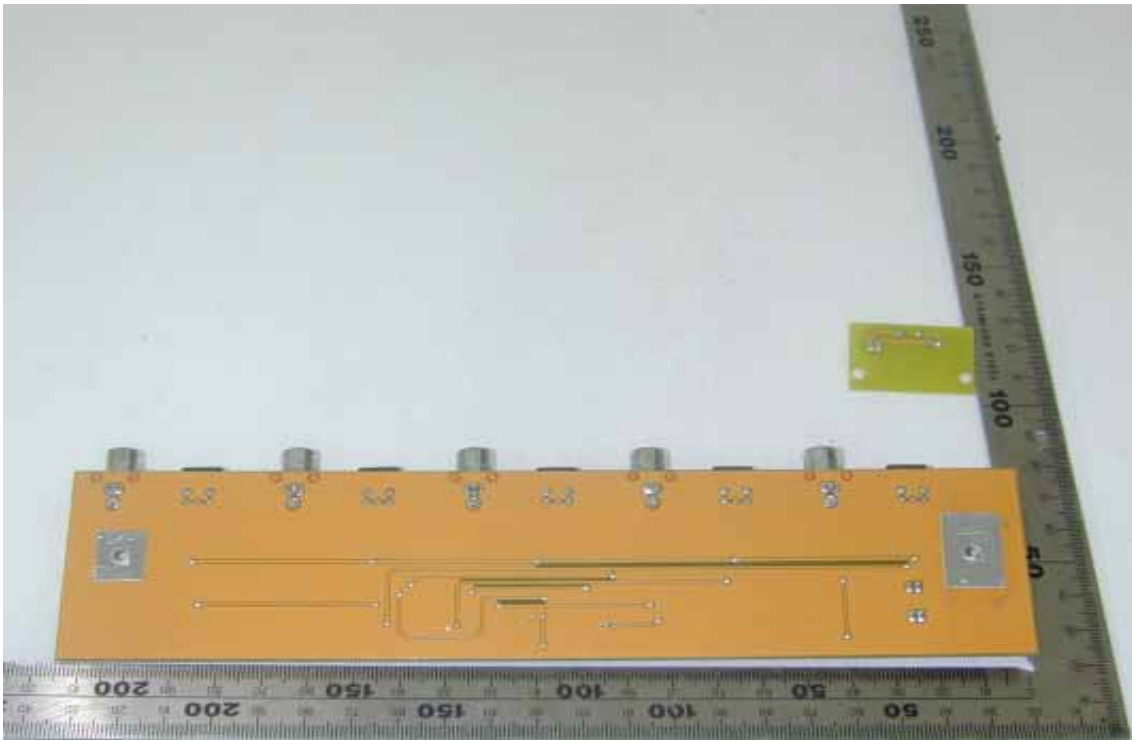

Solder Side of Main Board 2

### PHOTO OF EUT



Front View of Adaptor



Rear View of Adaptor

# Declaration of Conformity

Responsible Party Name :

Address :

Phone No :

Fax No :

Declares under our sole responsibility that the product

Product Name : Multimedia AV Distribution Amplifier

Model No. : DD0XXX

to which this declaration relates is in conformity with the following standards or other normative documents

This device complies with Part 15 of the FCC Rules. Operation is subject to the following two conditions : (1) this device may not cause harmful interference, and (2) this device must accept any interference received, including interference that may cause undesired operation.

Representative Person's Name : \_\_\_\_\_

Signature : \_\_\_\_\_

Date : \_\_\_\_\_

United States Department of Commerce  
National Institute of Standards and Technology

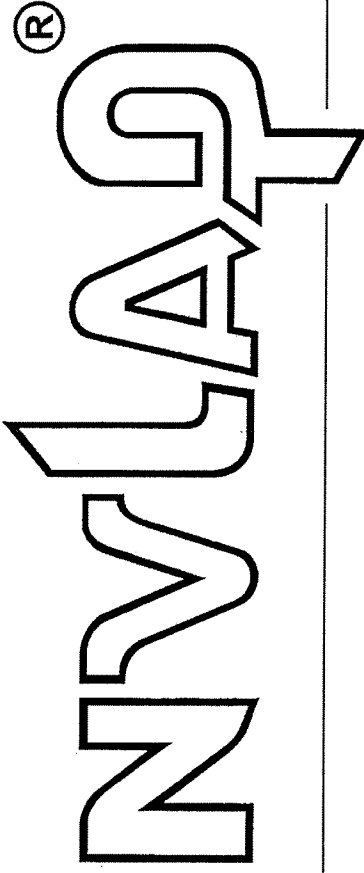

---

## Certificate of Accreditation to ISO/IEC 17025:2005

---

NVLAP LAB CODE: 200331-0

**HomeTek Technology Inc.**

Taipei Shien 236

TAIWAN

is accredited by the National Voluntary Laboratory Accreditation Program for specific services,  
listed on the Scope of Accreditation, for:

**ELECTROMAGNETIC COMPATIBILITY AND TELECOMMUNICATIONS**

*This laboratory is accredited in accordance with the recognized International Standard ISO/IEC 17025:2005.  
This accreditation demonstrates technical competence for a defined scope and the operation of a laboratory quality  
management system (refer to joint ISO-ILAC-IAF Communique dated 18 June 2005).*

2007-10-01 through 2008-09-30

Effective dates



*Jolly S. Buce*

For the National Institute of Standards and Technology



**SCOPE OF ACCREDITATION TO ISO/IEC 17025:2005**

**HomeTek Technology Inc.**

P.O Box: 13-131, Pan-Chiao City  
No. 67-9 Shir Men Rd., Tu Chen City  
Taipei Shien 236  
TAIWAN

Mr. Grant Huang

Phone: 886-2-22608375 Fax: 886-2-22748013

E-Mail: hometek@ms15.hinet.net

**ELECTROMAGNETIC COMPATIBILITY  
AND TELECOMMUNICATIONS**

**NVLAP LAB CODE 200331-0**

*NVLAP Code Designation / Description*

**Emissions Test Methods:**

12/CIS14a	EN 55014-1 (1993), A1 (1997), A2 (1999):
12/CIS14a2	BS EN 55014-1 (2001) with A1 and A2: Electromagnetic compatibility - Requirements for household appliances, electric tools and similar apparatus - Part 1: Emission
12/CIS14b1	AS/NZS CISPR 14-1 (2003): Electromagnetic Compatibility - Requirements for household appliances, electric tools and similar apparatus - Part 1: Emission
12/CIS14c	CNS 13783-1: Electromagnetic Compatibility Requirements for household appliances, electric tools and similar apparatus - Part 1: Emissions
12/CIS14d	IEC/CISPR 14-1 (2001) and A1 (2001): Electromagnetic Compatibility - Requirements for household appliances, electric tools and similar apparatus - Part 1: Emissions
12/CIS14x	IEC/CISPR 14-1, Ed. 4 (2003): Electromagnetic Compatibility - Requirements for household appliances, electric tools and similar apparatus - Part 1: Emission
12/CIS22	IEC/CISPR 22 (1997) & EN 55022 (1998) + A1(2000): Limits and methods of measurement of radio disturbance characteristics of information technology equipment

2007-10-01 through 2008-09-30

*Effective dates*

*For the National Institute of Standards and Technology*



# National Voluntary Laboratory Accreditation Program



## ELECTROMAGNETIC COMPATIBILITY AND TELECOMMUNICATIONS

NVLAP LAB CODE 200331-0

<i>NVLAP Code</i>	<i>Designation / Description</i>
12/CIS22a	IEC/CISPR 22 (1993) and EN 55022 (1994): Limits and methods of measurement of radio disturbance characteristics of information technology equipment, Amendment 1 (1995) and Amendment 2 (1996)
12/CIS22b	CNS 13438 (1997): Limits and Methods of Measurement of Radio Interference Characteristics of Information Technology Equipment
12/CIS22c	IEC/CISPR 22, Fourth Edition (2003-04) & EN 55022 (1998): Information technology equipment - Radio disturbance characteristics - Limits and methods of measurement
12/FCC15b	ANSI C63.4 (2003) with FCC Method 47 CFR Part 15, Subpart B: Unintentional Radiators
12/T51a	AS/NZS CISPR 22 (2004): Information technology equipment - Radio disturbance characteristics - Limits and methods of measurement
12/VCCIa	VCCI: Agreement of Voluntary Control Council for Interference by Information Technology Equipment - Technical Requirements: V-3/2005.04

2007-10-01 through 2008-09-30

*Effective dates*

*For the National Institute of Standards and Technology*