



ADDRESS: No. 67-9, Shir Men Road, Tu Cheng City,
Taipei Hsien, Taiwan

PHONE : 886-2-22608375 FAX : 886-2-22748013

E - mail : hometek@ms15.hinet.net

CE TEST REPORT FOR

APPLICANT : Smart Home Engineering Corp.
ADDRESS : 10F., No. 493, Chung-Cheng Rd.,
Hsin-Tien City, Taipei 231, Taiwan, R. O. C.
Receipt Date : 12/13/2004 Final Test Date: 12/27/2004
EUT : Converter
MODEL NO. : RS0XX

MEASUREMENT PROCEDURE USED

EN 61000-6-3 / CISPR 22 Class B / EN61000-3-2 / EN61000-3-3 / EN 50130-4 GIVEN IN
EUROPEAN COUNCIL DIRECTIVE 2004/108/EC

This test result of this report applies to above tested sample only.

This test report shall not be reproducing in part without written approval of HomeTek Technology Inc.

PREPARED BY :

HomeTek Technology Inc.

No. 67-9, Shir Men Road, Tu Cheng City,

Taipei Hsien. Taiwan

Report # : EB6K020

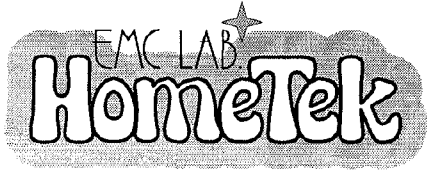

HomeTek Technology Inc.

ADDRESS: No. 67-9, Shir Men Road, Tu Cheng City,
Taipei Hsien, Taiwan, R. O. C.

PHONE : 886-2-22608375 FAX : 886-2-22748013

E - mail : hometek@ms15.hinet.net

CERTIFICATE OF COMPLIANCE

EUT : Converter

MODEL NO. : RS0XX

Receipt Date : 12/13/2004 Final Test Date: 12/27/2004

REPORT # : EB6K020

APPLICANT : Smart Home Engineering Corp.

ADDRESS : 10F., No. 493, Chung-Cheng Rd.,
Hsin-Tien City, Taipei 231, Taiwan, R. O. C.

Measurement procedure used:

**EMI: EN 61000-6-3 (2001): CISPR 22 (1997) Class B,
EN 61000-3-2 (2000), EN 61000-3-3 (1995) + A1 (2001)**

EMS: EN 50130-4 (1996) + A1 (1998):

**IEC 61000-4-2 (2001), IEC 61000-4-3 (2002), IEC 61000-4-4 (2004),
IEC 61000-4-5 (2001), ENV 50141 (1993), IEC 61000-4-11 (2004)**

We hereby show that:

The measurements shown in this test report were made in accordance with the procedures given in **EUROPEAN COUNCIL DIRECTIVE 2004/108/EC**, and the energy emitted by the equipment was found to be within the limits applicable. This product, which has been issued the test report listed as above in HomeTek Technology Inc., is based on single evaluation of one sample and confirmed to comply with the requirements of the above-mentioned EMC standard.

This test report is a duplicate of original one (report No. EB3L029, issued on 2005, 01, 26),
applicant and model No. is modified.

APPROVED BY : 

ALAIN LIN / Assistant Manage

DESCRIPTION OF UPGRADE OF TEST STANDARDS

Applicant: Smart Home Engineering Corp.

Product Name: Converter

Model Number: RS0XX

The test standard of this report (No. EB6K020) is updated from original one (No. EB3L029) with the procedures given in **EUROPEAN COUNCIL DIRECTIVE 2004/108/EC: EN 61000-6-3 (2001): CISPR 22 (1997) Class B / EN 61000-3-2 (2000) / EN 61000-3-3 (1995) + A1 (2001) / EN 50130-4 (1996) + A1 (1998): IEC 61000-4-2 (2001), IEC 61000-4-3 (2002), IEC 61000-4-4 (2004), IEC 61000-4-5 (2001), ENV 50141 (1993), IEC 61000-4-11 (2004)**. According to EUT's specification and operation manual, the test procedures of new version of standards are applied to EUT. Thus, we HomeTek issue a new certificate with new version of test standard.

HomeTek Inc.

November, 23, 2007



ALAIN LIN / Assistant Manager

TEST REPORT CERTIFICATION

EMC of electrical appliances

Report reference No. : EB6K020
 Date of issue : NOV., 23, 2007
 Applicant : Smart Home Engineering Corp.
 Address : 10F., No. 493, Chung-Cheng Rd.,
 Hsin-Tien City, Taipei 231, Taiwan, R. O. C.
 Manufacturer : Smart Home Engineering Corp.
 Type of test object : Converter
 Model/type reference : RS0XX
 Test Result : Complied
 Testing laboratory : HomeTek Technology Inc.
 Address : No. 67-9, Shir Men Road, Tu Cheng City, Taipei Hsien,
 Taiwan, R. O. C.
 TEL / FAX : +886-2-22608375 / +886-2-22748013
 E-mail : hometek@ms15.hinet.net
 Standard : EN 61000-6-3 (2001): CISPR 22 (1997) Class B,
 EN 61000-3-2 (2000), EN 61000-3-3 (1995) + A1 (2001),
 EN 50130-4 (1996) + A1 (1998):
 IEC 61000-4-2 (2001), IEC 61000-4-3 (2002),
 IEC 61000-4-4 (2004), IEC 61000-4-5 (2001),
 ENV 50141 (1993), IEC 61000-4-11 (2004)

Tested by (+ signature) : *Jason Lin / Engineer* Jason Lin

Approved by (+ signature) : *Alain Lin / Assistant Manager* Alain Lin



DESCRIPTION OF UPGRADE OF TEST STANDARDS 1

TEST REPORT CERTIFICATION..... 2

TABLE OF CONTENTS 3

GENERAL INFORMATION..... 5

MODIFICATION LIST 6

CONDUCTED POWER LINE TEST 7

 1 TEST PROCEDURE..... 7

 2 RESULT OF CONDUCTED EMISSION TEST..... 7

RADIATED EMISSION TEST 8

 1 TEST INSTRUMENTS & FACILITIES..... 8

 2 TEST PROCEDURE..... 9

 3 TEST SETUP 9

 4 CONFIGURATION OF THE EUT 10

 5 EUT OPERATING CONDITION..... 13

 6 LIMIT OF RADIATED EMISSION CLASS B 13

 7 RESULT OF RADIATED EMISSION TEST..... 13

 8 RADIATED EMISSION TEST DATA (PAGE 1)..... 14

 9 RADIATED EMISSION TEST DATA (PAGE 2)..... 15

HARMONICS TEST..... 16

 1 TEST PROCEDURE..... 16

 2 RESULT OF HARMONICS TEST 16

VOLTAGE FLUCTUATIONS TEST 17

 1 TEST PROCEDURE..... 17

 2 RESULT OF VOLTAGE FLUCTUATIONS TEST 17

ELECTROSTATIC DISCHARGE IMMUNITY TEST (ESD) 18

 1 TEST INSTRUMENTS & FACILITIES..... 18

 2 TEST PROCEDURE..... 18

 3 TEST SETUP 18

 4 CONFIGURATION OF THE EUT 19

 5 EUT OPERATION CONDITION..... 19

 6 TEST CONDITION 19

 7 PERFORMANCE CRITERIA 19

 8 TEST RESULT 20

RADIO FREQUENCY ELECTROMAGNETIC FIELD IMMUNITY TEST (RF)..... 21

 1 TEST INSTRUMENTS & FACILITIES..... 21

 2 TEST PROCEDURE..... 21

 3 TEST SETUP 22

 4 CONFIGURATION OF THE EUT 23



5 OPERATION CONDITION OF EUT 23

6 TEST CONDITION 23

7 PERFORMANCE CRITERIA 23

8 TEST RESULT 24

ELECTRICAL FAST TRANSIENT/BURST IMMUNITY TEST (EFT)..... 25

1 TEST PROCEDURE..... 25

2 RESULT OF ELECTRICAL FAST TRANSIENT/BURST IMMUNITY TEST..... 25

SURGE IMMUNITY TEST 26

1 TEST INSTRUMENTS & FACILITIES..... 26

2 TEST PROCEDURE..... 26

3 TEST SETUP 26

4 TEST LEVELS..... 27

5 CONFIGURATION OF THE EUT 27

6 EUT OPERATION CONDITION..... 27

7 CONDITIONS DURING TESTING..... 28

8 PERFORMANCE CRITERIA 28

9 TEST RESULT 29

IMMUNITY TEST TO CS CONDUCTED DISTURBANCE 30

1 TEST INSTRUMENTS & FACILITIES..... 30

2 TEST PROCEDURE..... 30

3 TEST SETUP 31

4 TEST LEVELS..... 32

5 CONFIGURATION OF THE EUT 32

6 EUT OPERATION CONDITION..... 32

7 CONDITIONS DURING TESTING..... 32

8 PERFORMANCE CRITERIA 33

9 TEST RESULT 33

VOLTAGE DIPS, SHORT INTERRUPTIONS IMMUNITY TEST AND MAIN SUPPLY VARIATIONS 34

1 TEST PROCEDURE..... 34

2 RESULT OF VOLTAGE DIPS, SHORT INTERRUPTIONS IMMUNITY TEST AND MAIN SUPPLY VARIATIONS 34

APPENDIX A

PHOTOS OF TEST CONFIGURATION

APPENDIX B

PHOTOS OF EUT

GENERAL INFORMATION

- 1 APPLICANT : Smart Home Engineering Corp.
- 2 ADDRESS : 10F., No. 493, Chung-Cheng Rd.,
Hsin-Tien City, Taipei 231, Taiwan, R. O. C.
- 3 MANUFACTURER : Smart Home Engineering Corp.
- 4 ADDRESS : 10F., No. 493, Chung-Cheng Rd.,
Hsin-Tien City, Taipei 231, Taiwan, R. O. C.
- 5 DESCRIPTION OF EUT :
- EUT : Converter
- Model : RS0XX
- Serial # : N/A

5.1 The difference between series of models RS0XX is different operation system. The worst case of EMC test model is RS001 and the final test data were shown in this test report.

- 6 FEATURES OF EUT :

Please refer to user manual or product specification.

MODIFICATION LIST

THE FOLLOWING ACCESSORIES WERE ADDED TO THE EUT DURING TESTING :

NO MODIFICATION BY HOMETEK TECHNOLOGY INC.

CONDUCTED POWER LINE TEST

1 TEST PROCEDURE

According to **EN 61000-6-3**.

2 RESULT OF CONDUCTED EMISSION TEST

N/A (Conducted Power Line Test is not applicable to this EUT (Model : RS001)).

RADIATED EMISSION TEST

1 TEST INSTRUMENTS & FACILITIES

The following test Instruments was used during the radiated emission test :

Item	Instruments /facilities	Specification	Manufacturer	Model # / S/N#	Date of Cal.
1	OPEN AREA TEST SITE	<input checked="" type="checkbox"/> OATS 3			JUL/2004
2	EMI TEST RECEIVER	20Hz ~ 26.5GHz	ROHDE & SCHWARZ	ESMI 845442/006	JAN/2004
3	PRE-AMPLIFIER	9KHz ~ 3000MHz	ADVANTEST	BB525C 90081001	SEP/2004
4	ANTENNA (BI-LOG)	25MHz ~ 2GHz	SCHAFFNER	CBL6112B S/N : 2614	MAY/2004
5	Attenuation	50Ω/6dB	JYE BAO	FAT-N (M-F) 001	JUL/2004
6	Cable	10m	SUHNER	RG214/U OS3-003	DEC/2004
7	Cable	14m	BELDEN	9913 OS3-001	DEC/2004
8	EMI 32 (software)	N/A	AUDIX	19991013-0923	N/A

Note : Items 1 ~ 7 were calibrated within period of 1 year.

2 TEST PROCEDURE

- 2.1 The EUT was test according to **CISPR 22 Class B**.
- 2.2 The radiated test was performed at HomeTek Lab's Open Site 3.
- 2.3 The frequency range from 30 MHz to 1 GHz, the measurement were made at 10 meters, with a BI-log antenna.

3 TEST SETUP

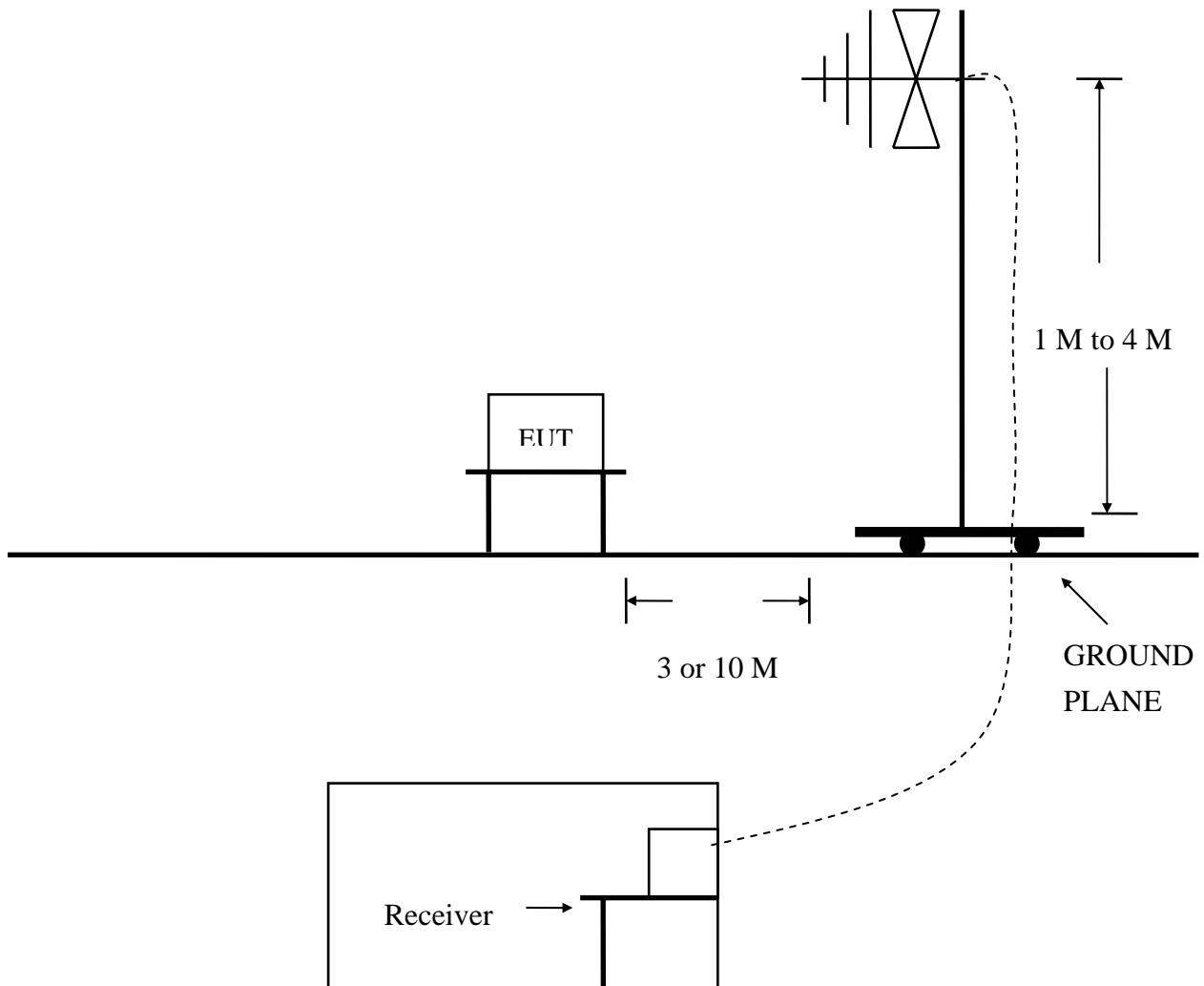

(Details for setup configuration, please refer to appendix A.)

4 CONFIGURATION OF THE EUT

The EUT was configured according to **EN 61000-6-3**. All I/O ports were connected to the appropriate peripherals. All peripherals and cables are listed below (including internal device) :

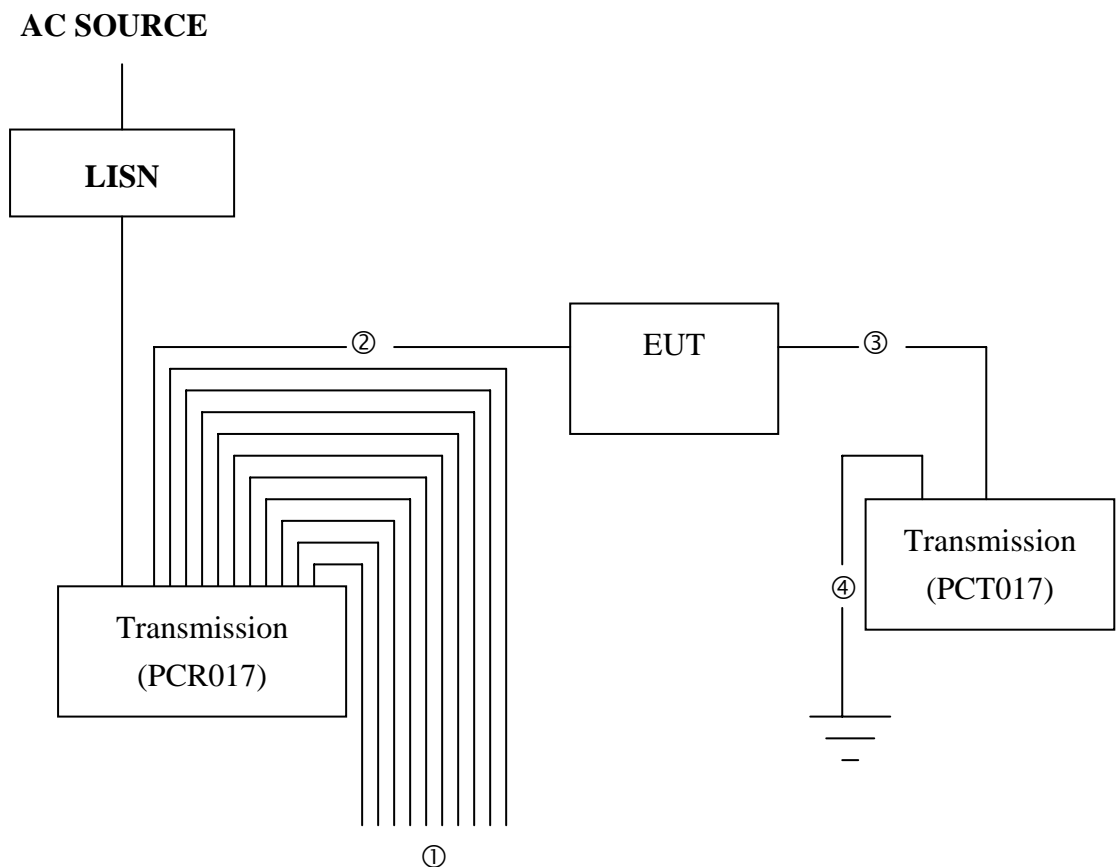

- ① Data cable floating x10
- ② Twisted Pair Cable
- ③ Twisted Pair Cable
- ④ Connect to Ground

Figure 1



4.1 EUT

EUT Type : Proto Type Engineer Type Mass Production
Condition when received : Good Damage : _____
Device : Converter
Applicant : Smart Home Engineering Corp.
Manufacturer : Smart Home Engineering Corp.
Model Number : RS0XX
Serial Number : N/A
FCC ID : N/A
RS485 Port : Metal Type Connector
RS232 Port : Metal Type Connector
Power Cord : N/A
Power Supply Type : N/A

4.2 PERIPHERALS

Transmission

Manufacturer : SMART CABLING & TRANSMISSION CORP.
Model Number : PCR017
Serial Number : N/A
FCC ID : N/A
Data Cable : Un-Shielded, 2.5 m, Connected to the RS485 Port
Power Cord : Un-Shielded, 1.8 m



Transmission

Manufacturer : SMART CABLING & TRANSMISSION CORP.

Model Number : PCT017

Serial Number : N/A

FCC ID : N/A

Data Cable : Un-Shielded, 0.1 m, Connected to the RS232 Port

Power Cord : Un-Shielded, 1.8 m

4.3 REMARK : N/A

5 EUT OPERATING CONDITION

- 5.1 The frequency of the EUT is none.
- 5.2 Configure the EUT according to the **EN 61000-6-3**.
- 5.3 Turn on all the power of EUT and peripheral
- 5.4 Serial port of Support Unit1(Transmission PCT017) connected with the RS232 Port of EUT via 0.1m cable
- 5.5 EUT's RS485 Port connected with the serial port of Support Unit2(Transmission PCR017) via 2.5m cable
- 5.6 Monitor the status of output port of EUT during the test (For EMS Testing)
- 5.7 **The photos of conducted test configuration, please refer to appendix A.**

6 LIMIT OF RADIATED EMISSION CLASS B

Frequency (MHz)	Measurement Distance	Limit (dBuV/m)
30 - 230	10 (M)	30
230 - 1000	10 (M)	37

7 RESULT OF RADIATED EMISSION TEST

- 7.1 The frequency range from 30 MHz to 1 GHz was investigated.
- 7.2 All readings below or equal 1 GHz are quasi-peak or peak values with resolution bandwidth of 120 KHz.
- 7.3 The measurements were made at 10 meters of HomeTek Lab's open site 3.
- 7.4 Temperature : 33 °C, Humidity : 55 % RH.
- 7.5 Deviation form the test standards and rules : None.
- 7.6 The radiated emission result were gained by the following method :
 Level = Reading Level + Probe Factor (Antenna Factor) + Cable Loss – Preamp Factor
 Over Limit = Level – Limit Line
- 7.7 Result : **PASSED**



8 RADIATED EMISSION TEST DATA (PAGE 1)



HomeTek Technology Inc.

No 67-9, Shi-Men Rd., Tu-Chen City,
Taipei County, Taiwan R.O.C.
Tel: 02-22608375
Fax: 02-22748013

Data#: 1 File#: 31029.emi

Date: 2004-12-15 Time: 16:58:28

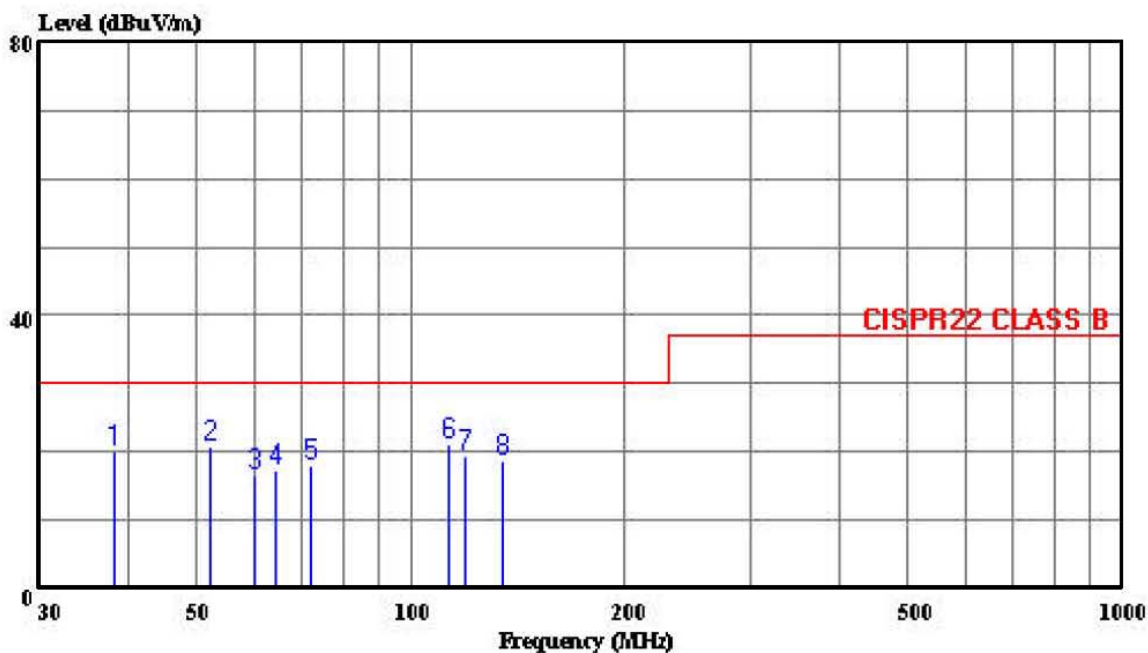

Trace:

Ref Trace:

Condition: CISPR22 CLASS B 10m CHASE 2614 052604 HORIZONTAL

cut : Converter

power: 230V/50Hz

memo : RS001

Page: 1

	Limit	Over	ReadAntenna	Cable	Preamp			
Freq	Level	Line	Limit	Level	Factor	Loss	Factor	Remark
MHz	dBuV/m	dBuV/m	dB	dBuV	dB/m	dB	dB	
1	38.273	20.04	30.00	-9.96	35.82	13.17	0.94	29.89 Peak
2	52.260	20.69	30.00	-9.31	42.40	7.01	1.12	29.83 Peak
3	60.307	16.74	30.00	-13.26	39.58	5.68	1.17	29.70 Peak
4	64.253	17.17	30.00	-12.83	39.96	5.64	1.20	29.64 Peak
5	72.493	18.08	30.00	-11.92	40.27	6.04	1.27	29.50 Peak
6	112.507	21.14	30.00	-8.86	37.17	11.55	1.53	29.11 Peak
7	118.800	19.41	30.00	-10.59	35.32	11.68	1.56	29.15 Peak
8	134.220	18.78	30.00	-11.22	35.34	11.04	1.64	29.24 Peak



9 RADIATED EMISSION TEST DATA (PAGE 2)



HomeTek Technology Inc.

No 67-9, Shi-Men Rd., Tu-Chen City, Taipei County, Taiwan R.O.C. Tel:02-22608375 Fax:02-22748013

Data#: 2 File#: 31029.emi

Date: 2004-12-15 Time: 17:20:49

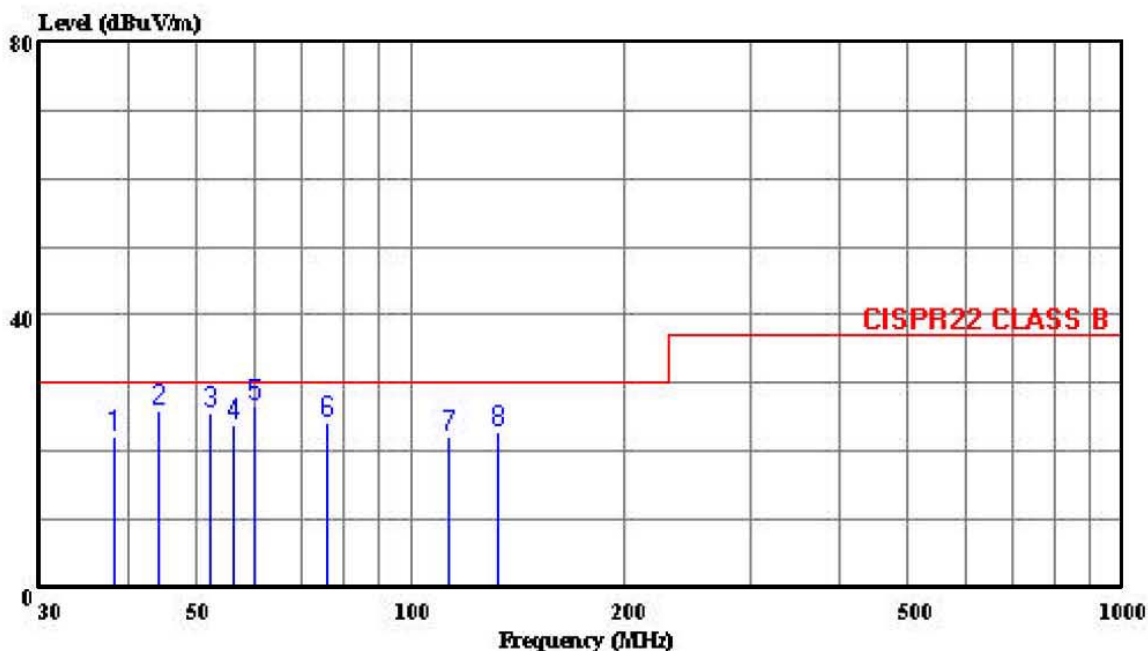

Trace:

Ref Trace:

Condition: CISPR22 CLASS B 10m CHASE 2614 052604 VERTICAL
 eut : Converter
 power: 230V/50Hz
 memo : RS001

Page: 1

	Limit	Over	ReadAntenna	Cable	Preamp				
Freq	Line	Limit	Level	Loss	Factor	Remark			
MHz	dBuV/m	dBuV/m	dB	dB	dB				
1	38.244	22.33	30.00	-7.67	38.11	13.17	0.94	29.89	Peak
2	44.311	26.08	30.00	-3.92	44.05	10.89	1.03	29.89	Peak
3	52.262	25.72	30.00	-4.28	47.43	7.01	1.12	29.83	Peak
4	56.289	23.77	30.00	-6.23	46.18	6.21	1.14	29.77	Peak
5	60.304	26.51	30.00	-3.49	49.35	5.68	1.17	29.70	Peak
6	76.420	24.37	30.00	-5.63	46.03	6.48	1.29	29.43	Peak
7	112.538	22.20	30.00	-7.80	38.23	11.55	1.53	29.11	Peak
8	132.631	22.95	30.00	-7.05	39.39	11.16	1.63	29.23	Peak

HARMONICS TEST

1 TEST PROCEDURE

According to **EN 61000-3-2 (2000)**.

2 RESULT OF HARMONICS TEST

N/A (This standard is not applicable to this EUT (Model : RS001)).

VOLTAGE FLUCTUATIONS TEST

1 TEST PROCEDURE

According to **EN 61000-3-3 (1995) + A1 (2001)**.

2 RESULT OF VOLTAGE FLUCTUATIONS TEST

N/A (This standard is not applicable to this EUT (Model : RS001)).

ELECTROSTATIC DISCHARGE IMMUNITY TEST (ESD)

1 TEST INSTRUMENTS & FACILITIES

Instruments/ Facilities	Manufacturer	Model # Serial #	Data Of Cal.
ESD TESTER	NOISEKEN	ESS-100L (A)	OCT/2004
VCP	HOMETEK	--	--

2 TEST PROCEDURE

According to **IEC 61000-4-2 (2001)**

According to **EN 50130-4 (1996) + A1 (1998)**

3 TEST SETUP

TABLE SIZE

160L X 80W X 80H cm

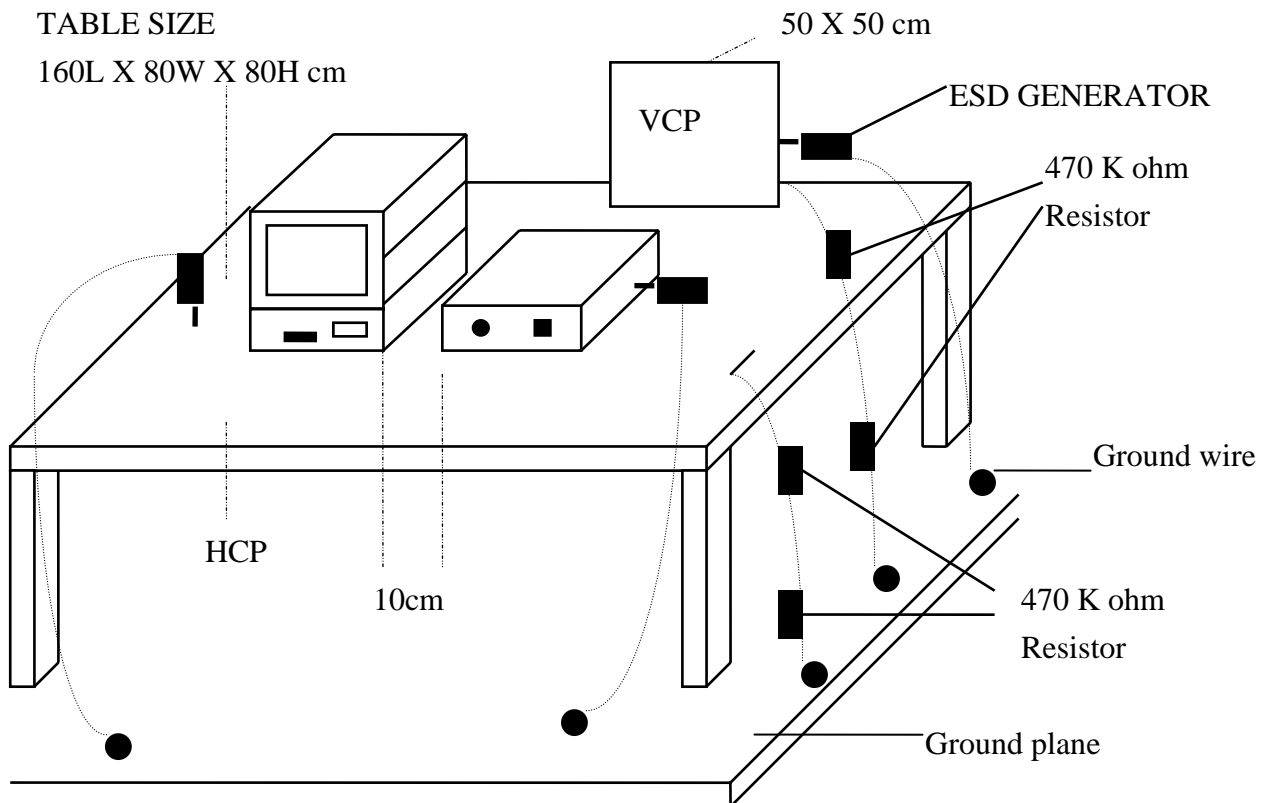

(Details for setup configuration, please refer to appendix A.)

4 CONFIGURATION OF THE EUT

Same as “Conducted Power Line test”, section 4

5 EUT OPERATION CONDITION

Same as “Conducted Power Line test”, section 5

6 TEST CONDITION

6.1 Test Level :

(A) ± 2 , ± 4 , ± 8 KV for air discharge.

(B) ± 2 , ± 4 , ± 6 KV for contact discharge.

6.2 Number of test : 10 Discharges / Test point / Polarity / Level

6.3 Time between test : ≥ 1 sec.

6.4 Temperature : 26 °C

6.5 Humidity : 54 % RH.

7 PERFORMANCE CRITERIA

There shall be no damage, malfunction or change of status due to the conditioning. Flickering of an indicator during the application of the discharges is permissible, providing that there is no residual change in the EUT or any change in outputs, which could be interpreted by associated equipment as a change.

The EUT shall meet the acceptance criteria for the functional test, after the conditioning.

8 TEST RESULT

Test Point	Air Discharge	Contact Discharge	Result
HCP	---	$\pm 2, \pm 4, \pm 6KV$	PASSED
VCP	---	$\pm 2, \pm 4, \pm 6KV$	PASSED
CASE	$\pm 2, \pm 4, \pm 8KV$	$\pm 2, \pm 4, \pm 6KV$	PASSED
I/O PORTS	$\pm 2, \pm 4, \pm 8KV$	$\pm 2, \pm 4, \pm 6KV$	PASSED
SCREWS	$\pm 2, \pm 4, \pm 8KV$	$\pm 2, \pm 4, \pm 6KV$	PASSED

9 Photos of test configuration please refer to appendix A.

RADIO FREQUENCY ELECTROMAGNETIC FIELD IMMUNITY TEST (RS)

1 TEST INSTRUMENTS & FACILITIES

Item	Instruments Facilities	Manufacturer	Model # Serial #	Data Of Cal.
1	SIGNAL GENERATOR	ROHDE & SCHWARZ	SMY02 845181/025	MAR/2004
2	AMPLIFIER	AMPLIFIER RESEARCH	100W1000M1A	N/A
3	FIELD SENSOR	AMPLIFIER RESEARCH	FP2000	AUG/2004
4	FIELD MONITOR	AMPLIFIER RESEARCH	FM2000	AUG/2004
5	RF VOLTMETER	BOONTON	9200C 361701AA	MAR/2004
6	RF PROBE	BOONTON	952001B 37082	MAR/2004
7	DIRECTION COUPLER	AMPLIFIER RESEARCH	DC6180 20521	N/A
8	ANTENNA	EMCO	3142B S/N: 1789	N/A
9	CONTROL PC	KB TECH	KB P586/133	--

Note : Items 3 ~ 4 were calibrated with two years and verified before testing.

2 TEST PROCEDURE

According to **IEC 61000-4-3 (2002)**

According to **EN 50130-4 (1996) + A1 (1998)**

3 TEST SETUP

FERRITE TILE

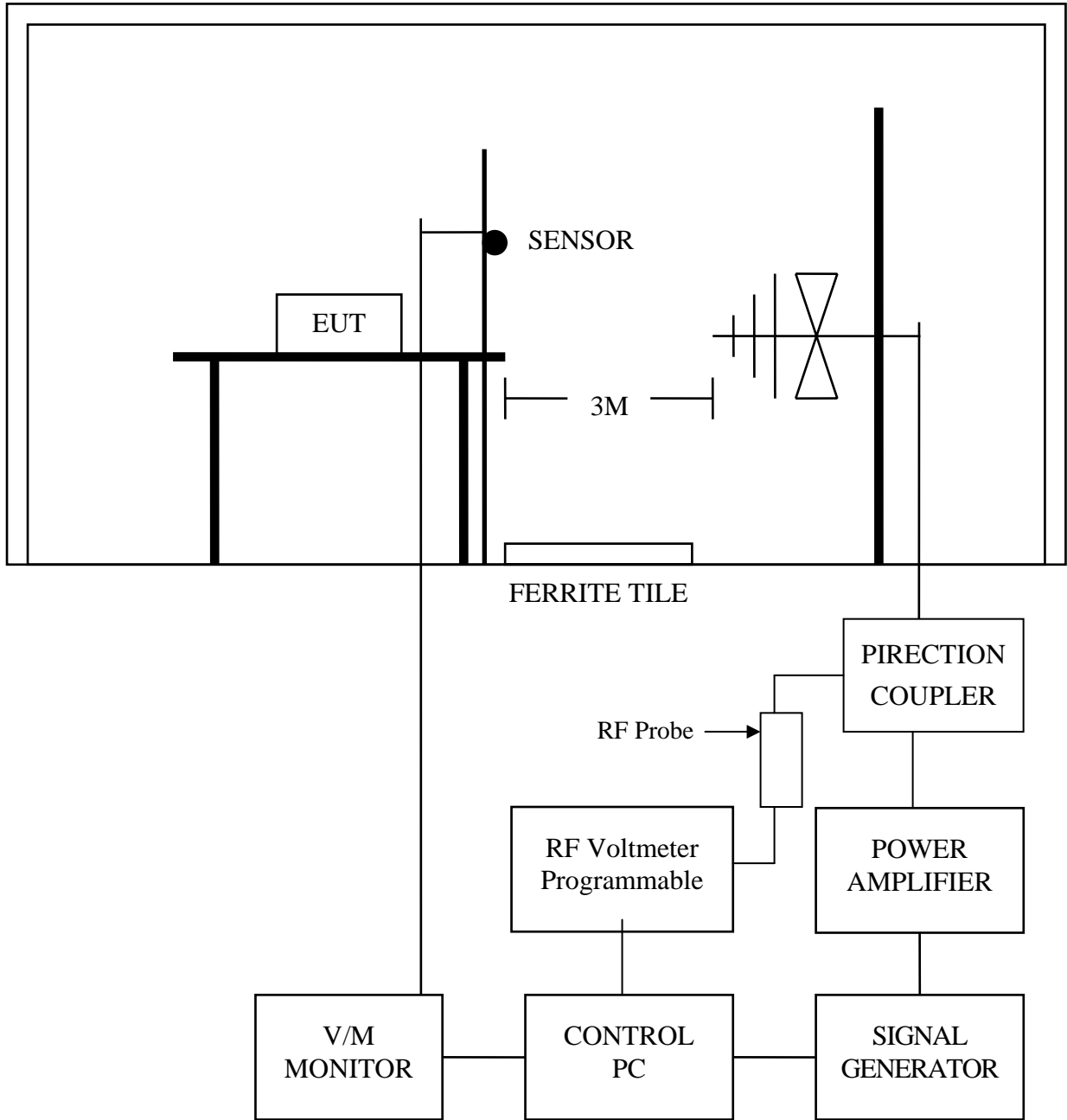

3.1 Chamber Size :

12M x 5M x 5M

(Details for setup configuration, please refer to appendix A.)

4 CONFIGURATION OF THE EUT

Same as “Conducted Power Line test”, section 4

5 OPERATION CONDITION OF EUT

Same as “Conducted Power Line test”, section 5

6 TEST CONDITION

- 6.1 Frequency Range : 80 MHz ~ 1000 MHz
(Frequency Range : 1.4 GHz ~ 2.0 GHz is not applicable for EN50130-4:1996+A1:1998)
- 6.2 Field Strength : 10 V / M (1KHz 80% Sinusoidal amplitude modulation)
10 V / M (1KHz 0.5s on : 0.5s off pulse modulation)
- 6.3 Frequency Step : 1 %, 3 sec. / each step size
- 6.4 Antenna Polarity : HORIZONTAL & VERTICAL
- 6.5 The four sides of EUT are tested
(FRONT, REAR, RIGHT, LEFT)
- 6.6 Temperature : 27 °C
- 6.7 Humidity : 60 % RH

7 PERFORMANCE CRITERIA

There shall be no damage, malfunction or change of status due to the conditioning. Flickering of an indicator during the conditioning is permissible, providing that there is no residual change in the EUT or any change in outputs, which could be interpreted by associated equipment as a change, and no such flickering of indicators occurs at a field strength of 3 V/m.

For components of CCTV system, where the status is monitored by observing the TV picture, then deterioration of the picture is allowed at 10 V/m, providing :

- a There is no permanent damage or change to the EUT (e.g. no corruption of memory or changes to programmable setting etc.);
- b At 3 V/m, any deterioration of the picture is so minor that the system could still be used;
- c There is no observable deterioration of the picture at 1 V/m.

The EUT shall meet the acceptance criteria for the functional test, after the conditioning.

8 TEST RESULT

ANT SIDE	HORIZONTAL	VERTICAL
FRONT	PASSED	PASSED
REAR	PASSED	PASSED
RIGHT	PASSED	PASSED
LEFT	PASSED	PASSED

9 Photos of test configuration please refer to appendix A.

ELECTRICAL FAST TRANSIENT/BURST IMMUNITY TEST (EFT)

1 TEST PROCEDURE

According to **IEC 61000-4-4 (2004)**

According to **EN 50130-4 (1996) + A1 (1998)**

2 RESULT OF ELECTRICAL FAST TRANSIENT/BURST IMMUNITY TEST

N/A (This standard is not applicable to this EUT (Model : RS001)).

SURGE IMMUNITY TEST

1 TEST INSTRUMENTS & FACILITIES

Instruments/ Facilities	Manufacturer	Model # Serial #	Data Of Cal.
SURGER-TESTER	HAEFELY	PSURGE 4010 583334-38	FEB/2004
ECAT CONTROL CENTER	KeyTek	E-Class Series 100 9502325	OCT/2004
I/O Signal Line Coupler / Decoupler	KeyTek	CM-I / OCD 0103234	--
CONTROL PC	KB TECH	KB P586/133	--

2 TEST PROCEDURE

According To **IEC 61000-4-5 (2001)**

According To **EN 50130-4 (1996) + A1 (1998)**

3 TEST SETUP

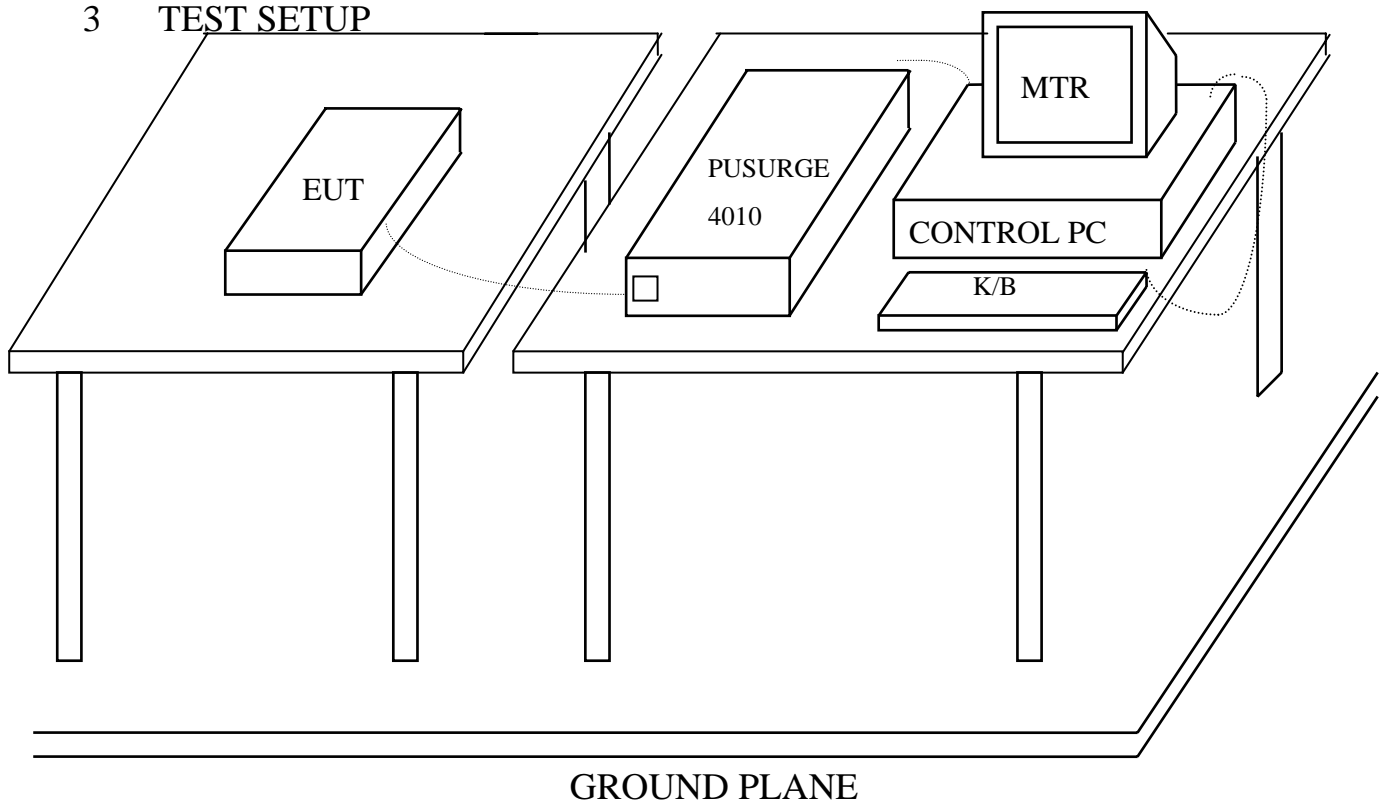

4 TEST LEVELS

- Ports for signal lines and control lines.
- Input and Output AC Power Ports.
- DC Input and DC Output Power Ports.

Environmental Phenomena	Test Specification		Units
	AC	DC	
Test voltage ¹⁾ :			
a.c. mains supply lines:			
Line to Line	±0.5, 1	N/A	KV (Charge Voltage)
Line to ground ²⁾	±0.5, 1, 2	N/A	KV (Charge Voltage)
other supply / signal lines: ³⁾			
Line to ground ⁴⁾	N/A	±0.5, 1	KV (Charge Voltage)
Polarity	+ and -		
Minimum number of surges at each polarity, voltage, coupling mode and line:			
a.c. mains supply lines	20 ⁵⁾		
Other supply / signal lines	5		
<p>1) The test voltages specified are the open-circuit voltages. The test voltages for the lower severity levels are included, because all the lower severity levels must also be satisfied.</p> <p>2) Via a 10Ω series resistor.</p> <p>3) No test is required where the manufacturer's specification indicates that it is not permitted to connect cables >30m long.</p> <p>4) Via a 40Ω series resistor.</p> <p>5) Five at each zero-crossing point and at the maximum and minimum points on the mains voltage wave.</p>			

5 CONFIGURATION OF THE EUT

Same as “Conducted Power Line test”, section 4

6 EUT OPERATION CONDITION

Same as “Conducted Power Line test”, section 5

7 CONDITIONS DURING TESTING

7.1 Coupling of power line :

- (A) Line to Line $\pm 0.5\text{KV}$, $\pm 1\text{KV}$ (AC)
- (B) Line to Earth $\pm 0.5\text{KV}$, $\pm 1\text{KV}$, $\pm 2\text{KV}$ (AC)
- (C) Line to Ground $\pm 0.5\text{KV}$, $\pm 1\text{KV}$ (DC)

7.2 Test Voltage of Signal Control Line : $\pm 0.5\text{KV}$, $\pm 1\text{KV}$

7.2 Polarity : POSITIVE / NEGATIVE

7.3 Phase shifting in a range between 0° to 360°

7.4 Repetition rate at least 1 per min

7.5 Test times on ac mains supply lines :

5 at each zero-crossing point and at the maximum and minimum point on the mains voltage wave.

7.6 Test times on signal lines : 5

7.7 Temperature : 27 °C (15°C ~ 35°C)

Humidity : 60 % RH.(10 % ~ 75%)

8 PERFORMANCE CRITERIA

There shall be no damage, malfunction or change of status due to the conditioning. Flickering of an indicator during the application of the surges is permissible, providing that there is no residual change in the EUT or any change in outputs, which could be interpreted by associated equipment as a change.

The EUT shall meet the acceptance criteria for the functional test, after the conditioning.

9 TEST RESULT

Signal Control Line :

Environmental Phenomena	TEST VOLTAGE	Units
Video Output	$\pm 0.5, 1$	KV (Charge Voltage)

9.1 Model : RS001

9.2 Final Result : PASSED

9.3 Remark :

10 Photos of test configuration please refer to appendix A.

IMMUNITY TEST TO CS CONDUCTED DISTURBANCE

1 TEST INSTRUMENTS & FACILITIES

Instruments/ Facilities	Manufacturer	Model # Serial #	Date Of Cal.
SIGNAL GENERATOR	ROHDE & SCHWARZ	SMY02 845181/025	MAR/2004
SIGNAL GENERATOR	Agilent	8648C 4108A05773	SEP/2004
AMPLIFIER	AMPLIFIER RESEARCH	75A250 25680	N/A
AMPLIFIER (75Watts 10KHz-250MHz)	AMPLIFIER RESEARCH	75A250AM1 306334	N/A
RF VOLTMETER	BOONTON	9200C 361701AA	MAR/2004
RF PROBE	BOONTON	952001B 37082	MAR/2004
DIRECTION COUPLER	AMPLIFIER RESEARCH	DC2600 20508	N/A
COUPLING DECOUPLING NETWORK	FCC	FCC-801-M3-25A 9993	FEB/2004
POWER METER	Boonton	4232A-01-02 98601	SEP/2004
POWER SENSOR	Boonton	51011-EMC 32862	SEP/2004
POWER SENSOR	Boonton	51011-EMC 32864	FEB/2004
EM Injection Clamp	Fischer Custom Communications, Inc.	F-203I-23mm 421	FEB/2004
CONTROL PC	KB TECH	KB P586/133	--

2 TEST PROCEDURE

According To **ENV 50141 (1993)**

According To **EN 50130-4 (1996) + A1 (1998)**

3 TEST SETUP

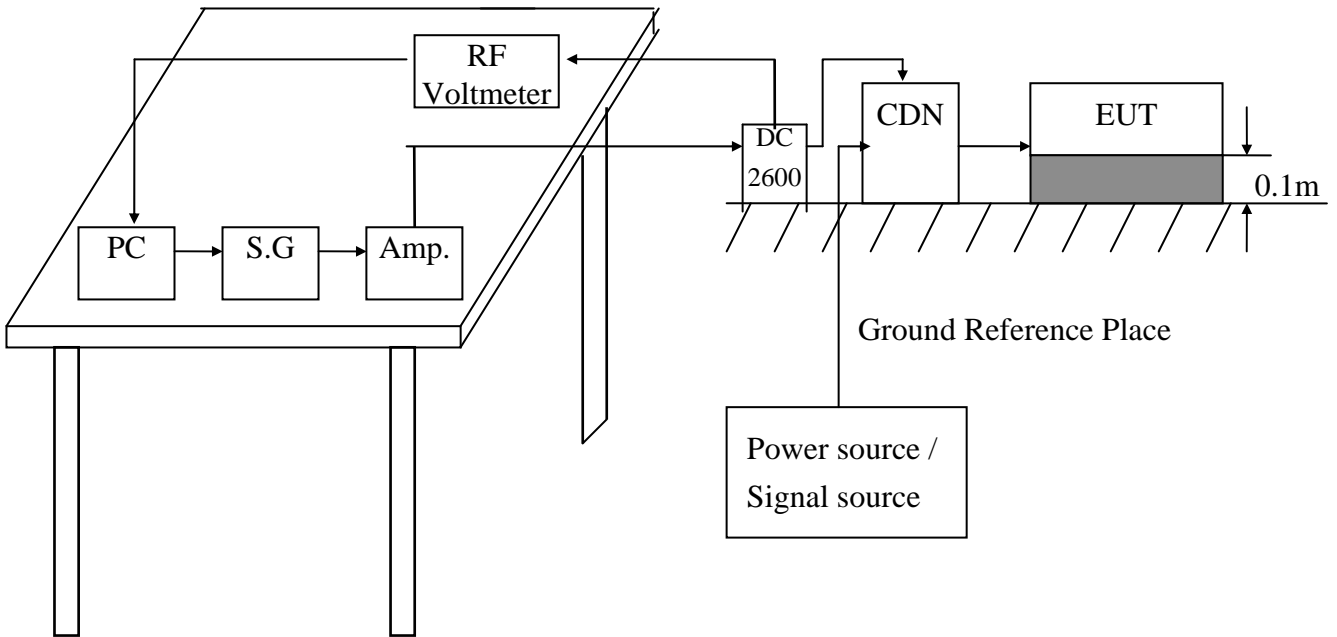

(Details for setup configuration, please refer to appendix A.)

4 TEST LEVELS

- Ports for signal lines and control lines.
- DC input and DC output power ports.
- Input and Output AC Power Ports.
- Functional earth Ports.

Environmental	Test Specification	Units
Radio-frequency	0.15 - 100	MHz
Common mode	10	V
Amplitude Modulation	80	% (1KHz)
Pulse Modulation	1	Hz (0.5s on : 0.5s off)

5 CONFIGURATION OF THE EUT

Same as “Conducted Power Line test”, section 4

6 EUT OPERATION CONDITION

Same as “Conducted Power Line test”, section 5

7 CONDITIONS DURING TESTING

7.1 The EUT tested type :

- Single unit
- Multiple unit

7.2 Dwell time : < 3 Seconds

7.3 Step size : < 1%

7.4 Test times : 3 times (pulse modulation)

7.5 Temperature : 27 °C (15°C ~ 35°C)

Humidity : 60 % RH.(10 % ~ 75%)

8 PERFORMANCE CRITERIA

There shall be no damage, malfunction or change of status due to the conditioning. Flickering of an indicator during the conditioning is permissible, providing that there is no residual change in the EUT or any change in outputs, which could be interpreted by associated equipment as a change, and no such flickering of the picture is allowed at 10V, providing :

- a There is no permanent damage or change to the EUT (e.g. no corruption of memory or changes to programmable settings etc.);
- b At $U_0 = 3V$, any deterioration of the picture is so minor that the system could still be used;
- c There is no observable deterioration of the picture at $U_0 = 1V$.

The EUT shall meet the acceptance criteria for the functional test, after the conditioning.

9 TEST RESULT

TEST Specification	Unit
0.15 - 100	MHz
10	V
80	% (1KHz)
1	Hz (0.5s on : 0.5s off)

9.1 Model : RS001

9.2 Final Result : PASSED

9.3 Remark :

10 Photos of test configuration please refer to appendix A.

VOLTAGE DIPS, SHORT INTERRUPTIONS IMMUNITY TEST AND MAIN SUPPLY VARIATIONS

1 TEST PROCEDURE

According To **IEC 61000-4-11 (2004)**

According To **EN 50130-4 (1996) + A1 (1998)**

2 RESULT OF VOLTAGE DIPS, SHORT INTERRUPTIONS IMMUNITY TEST AND MAIN SUPPLY VARIATIONS

N/A (This standard is not applicable to this EUT (Model : RS001)).



HomeTek Technology Inc.

Appendix A

PHOTOS OF TEST CONFIGURATION

PHOTO OF RADIATED EMISSION TEST

Model : RS001



Front View



Rear View

**PHOTO OF ELECTROSTATIC DISCHARGE IMMUNITY TEST
(ESD)**

Model : RS001



**PHOTO OF RADIO FREQUENCY ELECTROMAGNETIC FIELD
IMMUNITY TEST (RF)**



EB6K020



HomeTek Technology Inc.

Appendix B

PHOTOS OF EUT

PHOTO OF EUT

Model : RS001

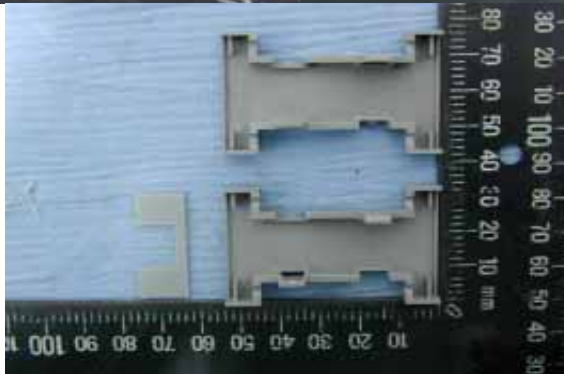
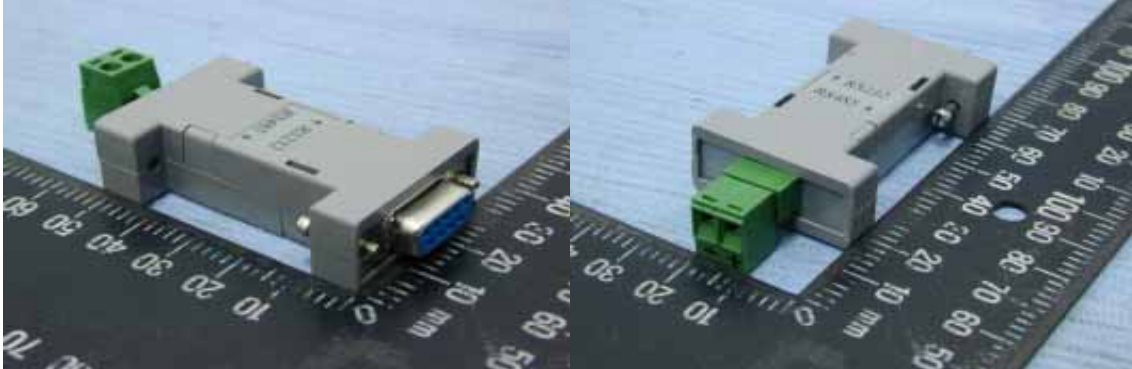

Full View of EUT

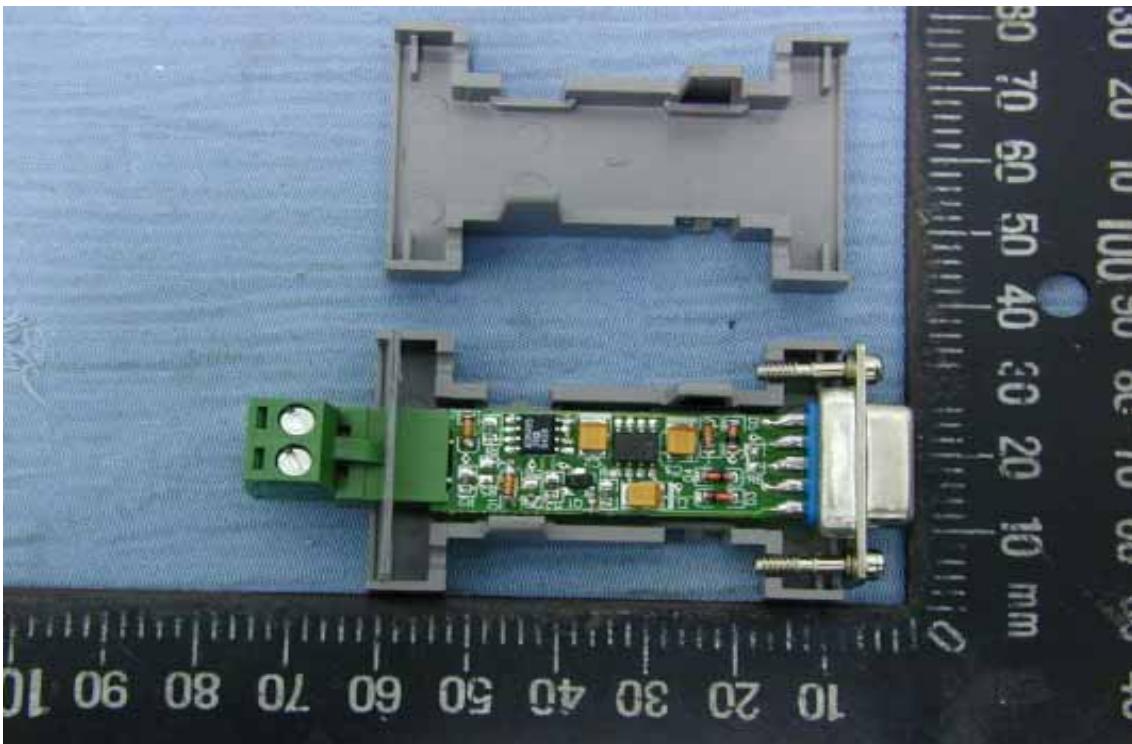

Inside View of EUT

PHOTO OF EUT

Model : RS001

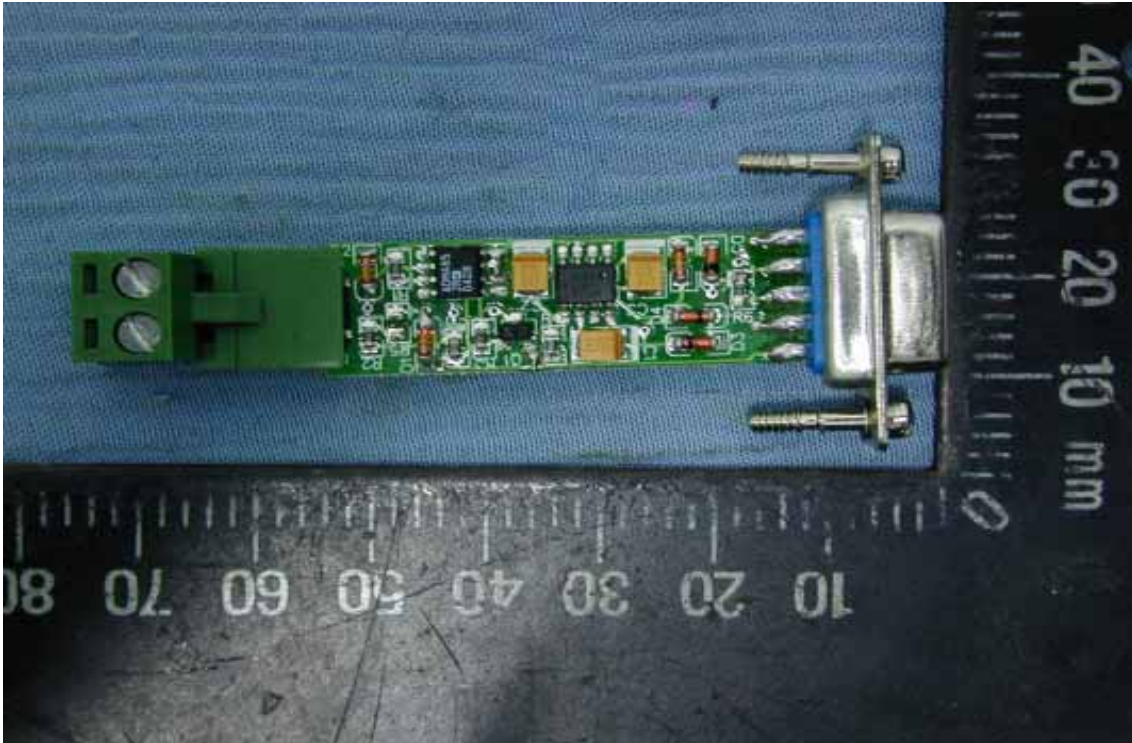

Component Side of Main Board

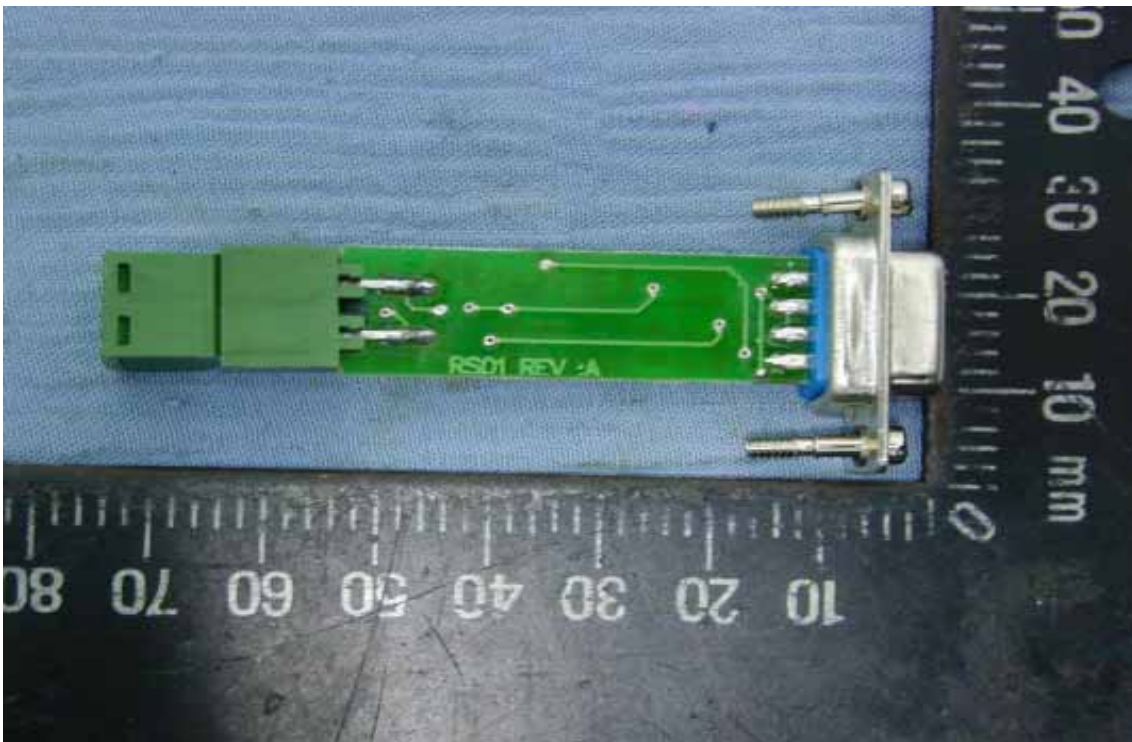

Solder Side of Main Board

Declaration of Conformity

We(Manufacturer/Importer)

(company name)

(address)

declares under our sole responsibility that the product

Product name : Converter

Model No. : RS0XX

to which this declaration relates is in conformity with the following standard(s) or other normative document(s)

- | | |
|---|--|
| <input checked="" type="checkbox"/> EN 61000-6-3 (2001) | <input checked="" type="checkbox"/> EN 50130-4 (1996)
+ A1 (1998) |
| <input checked="" type="checkbox"/> CISPR 22 Class B (1997) | <input checked="" type="checkbox"/> IEC 61000-4-2 (2001) |
| <input checked="" type="checkbox"/> EN 61000-3-2 (2000) | <input checked="" type="checkbox"/> IEC 61000-4-3 (2002) |
| <input checked="" type="checkbox"/> EN 61000-3-3 (1995) | <input checked="" type="checkbox"/> IEC 61000-4-4 (2004) |
| + A1 (2001) | <input checked="" type="checkbox"/> IEC 61000-4-5 (2001) |
| | <input checked="" type="checkbox"/> ENV 50141 (1993) |
| | <input checked="" type="checkbox"/> IEC 61000-4-11 (2004) |

following the provisions of 2004/108/EC Directive

Place: _____ Signature: _____

Date : _____ Full name: _____



Title: _____

TÜV Rheinland Taiwan Ltd.



Certificate of Appointment

for the applicant:

Hometek Technology Inc.
No. 67-9, Shir Men Rd., Tu-Cheng City,
Taipei Hsien 236, Taiwan, R.O.C.

has been authorized to carry out EMC tests by order and under supervision of TÜV Rheinland. It has successfully demonstrated capability to conduct measurement and to process test data according to:

**European and International EMC Standards as listed in the
Scope of Authorization on the attachment to this certificate**

An assessment of the facility was conducted by TÜV Rheinland auditors according to the TÜV Rheinland requirements for "Test Site Approval" with reference to

ISO 17 025:1999

Certificate No. : 10012161-2004

Valid until : February 14, 2006

TÜV Rheinland Taiwan Ltd.
Taipei, December 21, 2004

Dipl.-Ing. Andreas Klinker
Certification Body

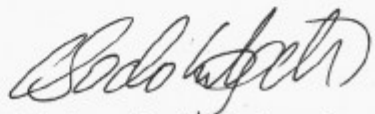
Dipl.-Ing. Bodo Kretzschmar
Product Safety and Quality



Attachment to
Certificate
of Appointment

SCOPE OF AUTHORIZATION

Hometek Technology Inc.
No. 67-9, Shir Men Rd., Tu-Cheng City,
Taipei Hsien 236, Taiwan, R.O.C.

European Standards

EN 50081-1	EN 61000-3-2	ENV 50140
EN 50081-2	EN 61000-3-3	ENV 50141
EN 50082-1	EN 61000-6-1	ENV 50204
EN 50130-4	EN 61000-6-2	
EN 50091-2	EN 61000-6-3	
EN 55011	EN 61000-6-4	
EN 55013	EN 61000-3-11	
EN 55014-1	EN 61000-4-2	
EN 55014-2	EN 61000-4-3	
EN 55022	EN 61000-4-4	
EN 55024	EN 61000-4-5	
EN 60601-1-2	EN 61000-4-6	
EN 60801	EN 61000-4-8	
EN 60945	EN 61000-4-11	
	EN 61204-3	

International Standards

CISPR 11	IEC 61000-4-2	IEC 61000-3-2
CISPR 13	IEC 61000-4-3	IEC 61000-3-3
CISPR 14-1	IEC 61000-4-4	IEC 61000-3-11
CISPR 14-2	IEC 61000-4-5	IEC 61000-6-1
CISPR 22	IEC 61000-4-6	IEC 61000-6-2
CISPR 24	IEC 61000-4-8	IEC 61000-6-3
	IEC 61000-4-11	IEC 61000-6-4
IEC 801.2	IEC 61000-4-12	IEC 60945
IEC 801.3		
IEC 801.4		

Certificate No. : 10012161-2004

Taipei, December 21 , 2004

Dipl.-Ing. Bodo Krätzschar
Product Safety and Quality



TÜV Rheinland Taiwan Ltd.

Certificate

of

Appointment

for the applicant:

Hometek Technology Inc.
No. 67-9, Shir Men Rd., Tu-Cheng City,
Taipei Hsien 236, Taiwan, R.O.C.

has been authorized to carry out EMC tests by order and under supervision of TÜV Rheinland. It has successfully demonstrated capability to conduct measurement and to process test data according to:

**European and International EMC Standards as listed in the
Scope of Authorization on the attachment to this certificate**

An assessment of the facility was conducted by TÜV Rheinland auditors according to the TÜV Rheinland requirements for "Test Site Approval" with reference to

ISO 17 025:1999

Certificate No. : 10012161-2006

Valid until : June 14, 2007

TÜV Rheinland Taiwan Ltd.
Taipei, April 13, 2006

Dipl.-Ing. Andreas Klinker
Certification Body

Dipl.-Ing. Bodo Kretzschmar
Product Safety and Quality



Attachment to
Certificate
of Appointment

SCOPE OF AUTHORIZATION

Hometek Technology Inc.
No. 67-9, Shir Men Rd., Tu-Cheng City,
Taipei Hsien 236, Taiwan, R.O.C.

European Standards

EN 50081-1	EN 61000-3-2	ENV 50140
EN 50081-2	EN 61000-3-3	ENV 50141
EN 50082-1	EN 61000-6-1	ENV 50204
EN 50130-4	EN 61000-6-2	
EN 50091-2	EN 61000-6-3	
EN 55011	EN 61000-6-4	
EN 55013	EN 61000-3-11	
EN 55014-1	EN 61000-4-2	
EN 55014-2	EN 61000-4-3	
EN 55022	EN 61000-4-4	
EN 55024	EN 61000-4-5	
EN 60601-1-2	EN 61000-4-6	
EN 60801	EN 61000-4-8	
EN 60945	EN 61000-4-11	
	EN 61204-3	

International Standards

CISPR 11	IEC 61000-4-2	IEC 61000-3-2
CISPR 13	IEC 61000-4-3	IEC 61000-3-3
CISPR 14-1	IEC 61000-4-4	IEC 61000-3-11
CISPR 14-2	IEC 61000-4-5	IEC 61000-6-1
CISPR 22	IEC 61000-4-6	IEC 61000-6-2
CISPR 24	IEC 61000-4-8	IEC 61000-6-3
	IEC 61000-4-11	IEC 61000-6-4
IEC 801.2	IEC 61000-4-12	IEC 60945
IEC 801.3		
IEC 801.4		

Certificate No. : 10012161-2006

Taipei, April 13, 2006

Dipl.-Ing. Bodo Kretzschmar
Product Safety and Quality



TÜV Rheinland Taiwan Ltd.

Certificate of Appointment

for the applicant:

**Hometek Technology Inc.
No. 67-9, Shir Men Rd., Tu-Cheng City,
Taipei Hsien 236, Taiwan, R.O.C.**

has been authorized to carry out EMC tests by order and under supervision of TÜV Rheinland. It has successfully demonstrated capability to conduct measurement and to process test data according to:

**European and International EMC Standards as listed in the
Scope of Authorization on the attachment to this certificate**

An assessment of the facility was conducted by TÜV Rheinland auditors according to the TÜV Rheinland requirements for "Test Site Approval" with reference to

ISO 17025: 2005

Certificate No. : 10012161-2007

Valid until : Sept. 7, 2008

TÜV Rheinland Taiwan Ltd.
Taipei, June 20, 2007

Dipl.-Ing. Andreas Klinker
Certification Body

Dipl.-Ing. Bodo Kretzschmar
Product Safety and Quality



Attachment to
Certificate

of Appointment

SCOPE OF AUTHORIZATION

Hometek Technology Inc.
No. 67-9, Shir Men Rd., Tu-Cheng City,
Taipei Hsien 236, Taiwan, R.O.C.

European Standards

EN 50081-1	EN 61000-3-3	ENV 50140
EN 50081-2	EN 61000-6-1	ENV 50141
EN 50082-1	EN 61000-6-2	ENV 50204
EN 50130-4	EN 61000-6-3	
EN 50091-2	EN 61000-6-4	
EN 55011	EN 61000-3-11	
EN 55013	EN 61000-4-2	
EN 55014-1	EN 61000-4-3	
EN 55014-2	EN 61000-4-4	
EN 55022	EN 61000-4-5	
EN 55024	EN 61000-4-6	
EN 60601-1-2	EN 61000-4-8	
EN 60801	EN 61000-4-11	
EN 60945	EN 61204-3	
EN 61000-3-2	EN 62040-2	

International Standards

CISPR 11	IEC 61000-4-2	IEC 61000-3-2
CISPR 13	IEC 61000-4-3	IEC 61000-3-3
CISPR 14-1	IEC 61000-4-4	IEC 61000-3-11
CISPR 14-2	IEC 61000-4-5	IEC 61000-6-1
CISPR 22	IEC 61000-4-6	IEC 61000-6-2
CISPR 24	IEC 61000-4-8	IEC 61000-6-3
IEC 801.2	IEC 61000-4-11	IEC 61000-6-4
IEC 801.3	IEC 61000-4-12	IEC 60945
IEC 801.4		IEC 62040-2

Certificate No. : 10012161-2007

Taipei, June 20, 2007

Dipl.-Ing. Bodo Kretzschmar
Product Safety and Quality