



HomeTek Technology Inc.

ADDRESS: No. 67-9, Shir Men Road, Tu Cheng City,
Taipei Hsien, Taiwan,
PHONE : 886-2-22608375 FAX : 886-2-22748013
E - mail : hometek@ms15.hinet.net



NVLAP Lab Code:200331-0

EMI TEST REPORT FOR

APPLICANT : Smart Home Engineering Corp.
ADDRESS : 10F., No. 493, Chung-Cheng Rd.,
Hsin-Tien City, Taipei 231, Taiwan, R. O. C.
EUT : Serial Data Distributor 1 In 16 Out In 1U Rack
Mounting Panel
MODEL NO. : RS0XXX



MEASUREMENT PROCEDURE USED

AS/NZS CISPR 22: 2004 Information technology equipment – Radio disturbance characteristics – Limits and methods of measurement

PREPARED BY :
HomeTek Technology Inc.
No. 67-9, Shir Men Road, Tu Cheng City,
Taipei Hsien. Taiwan
Report # : AS6K035



TABLE OF CONTENTS..... 2

CERTIFICATE 3

GENERAL INFORMATION..... 4

MODIFICATION LIST..... 5

CONDUCTED POWER LINE TEST 6

 1 TEST INSTRUMENTS & FACILITIES..... 6

 2 TEST PROCEDURE..... 6

 3 TEST SETUP 7

 4 CONFIGURATION OF THE EUT 9

 5 EUT OPERATING CONDITION..... 14

 6 LIMIT OF CONDUCTED POWER LINE EMISSION CLASS B..... 15

 7 RESULT OF CONDUCTED POWER LINE TEST..... 15

 8 CONDUCTED POWER LINE TEST DATA (PAGE 1)..... 16

 9 CONDUCTED POWER LINE TEST DATA (PAGE 2)..... 17

 10 CONDUCTED POWER LINE TEST DATA (PAGE 3)..... 18

 11 CONDUCTED POWER LINE TEST DATA (PAGE 4)..... 19

RADIATED EMISSION TEST..... 20

 1 TEST INSTRUMENTS & FACILITIES..... 20

 2 TEST PROCEDURE..... 21

 3 TEST SETUP 21

 4 CONFIGURATION OF THE EUT 23

 5 EUT OPERATING CONDITION..... 23

 6 LIMIT OF RADIATED EMISSION CLASS B 23

 7 RESULT OF RADIATED EMISSION TEST..... 23

 8 RADIATED EMISSION TEST DATA (PAGE 1)..... 24

 9 RADIATED EMISSION TEST DATA (PAGE 2)..... 25

APPENDIX A

PHOTOS OF TEST CONFIGURATION

APPENDIX B

PHOTOS OF EUT

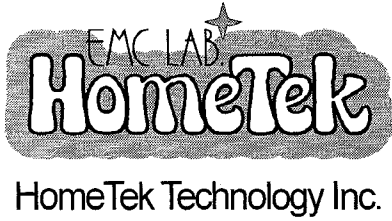

ADDRESS: No. 67-9, Shir Men Road, Tu Cheng City,
Taipei Hsien, Taiwan
PHONE : 886-2-22608375 FAX : 886-2-22748013
E - mail : hometek@ms15.hinet.net



CERTIFICATE

APPLICANT : Smart Home Engineering Corp.
ADDRESS : 10F., No. 493, Chung-Cheng Rd.,
Hsin-Tien City, Taipei 231, Taiwan, R. O. C.
Receipt Date : 05/15/2007 Final Test Date: 05/21/2007
EUT : Serial Data Distributor 1 In 16 Out In 1U Rack
Mounting Panel
MODEL NO. : RS0XXX

MEASUREMENT PROCEDURE USED :

AS/NZS CISPR 22: 2004 Information technology equipment – Radio
disturbance characteristics – Limits and methods of measurement

- THE MAXIMUM EMISSION LEVELS WERE COMPARED TO THE CISPR 22 CLASS B LIMITS BOTH RADIATED AND CONDUCTED EMISSION.
- THE ABOVE DEVICE WAS TESTED BY HOMETEK TECHNOLOGY INC. TO SHOWS THE MAXIMUM EMISSION LEVEL FROM THE DEVICE.
- THIS TEST RESULTS OF THIS REPORT APPLIES TO ABOVE TESTED SAMPLE ONLY.
- THIS TEST REPORT SHALL NOT BE REPRODUCE IN PART WITHOUT WRITTEN APPROVAL OF HOMETEK TECHNOLOGY INC.
- THE REPORT MUST NOT BE USED BY THE CLIENT TO CLAIM PRODUCT ENDORSEMENT BY NVLAP, NIST OR ANY AGENCY OF THE U. S. GOVERNMENT.
- THE TEST RESULTS ARE TRACEABLE TO THE NATIONAL OR INTERNATIONAL STANDARD.

This test report is a duplicate of original one (report No. AS6E017, issued on 2007, 05, 29),
applicant and model No. is modified.

APPROVED BY : ALAIN LIN 12/11/2007

ALAIN LIN / Assistant Manage

GENERAL INFORMATION

- 1 APPLICANT : Smart Home Engineering Corp.
- 2 ADDRESS : 10F., No. 493, Chung-Cheng Rd.,
Hsin-Tien City, Taipei 231, Taiwan, R. O. C.
- 3 MANUFACTURER : Smart Home Engineering Corp.
- 4 ADDRESS : 10F., No. 493, Chung-Cheng Rd.,
Hsin-Tien City, Taipei 231, Taiwan, R. O. C.
- 5 DESCRIPTION OF EUT :
- EUT : Serial Data Distributor 1 In 16 Out In 1U Rack
Mounting Panel
- Model Number : RS0XXX
- Serial # : N/A

5.1 The difference between series of models RS0XXX are as shown below:

- (1) The first and second “X” represents different system input.
- (2) The third “X” represent different accessory.

The PCB layout is similar. The worst case of EMI test data were shown in this test report.

6 FEATURES OF EUT :

Please refer to user manual or product specification.



MODIFICATION LIST

THE FOLLOWING ACCESSORIES WERE ADDED TO THE EUT DURING TESTING :

NO MODIFICATION BY HOMETEK TECHNOLOGY INC.

CONDUCTED POWER LINE TEST

1 TEST INSTRUMENTS & FACILITIES

The following test Instruments was used during the conducted test :

| Item | Instruments/ Facilities | Specification | Manufacturer | Model # S/N | Date Of Cal. |
|------|----------------------------|---------------------------------|--------------------|-----------------------------|-----------------|
| 1 | EMI Receiver | 9KHz ~ 30MHz | ROHDE & SCHWARZ | ESHS 30 844827/007 | FEB/2007 |
| 2 | LISN (for EUT) | 50Ω/50uH/100A 150KHz ~ 30MHz | SCHWARZ BECK | NNLK 8121 8121370 | OCT/2006 |
| 3 | LISN (for Support Unit) | 50Ω/50uH/10A 9KHz ~ 30MHz | ROHDE & SCHWARZ | ESH3-Z5 846128/007 | MAR/2007 |
| 4 | Terminator | 50Ω | N/A | N/A | NOV/2006 |
| 5 | Attenuation | 50Ω/10dB | Mini-Circuit | NAT-10 AT-002 | JUL/2006 |
| 6 | Cable | 5.4m | SUHNER | RG-223 CON2-002 | AUG/2006 |
| 7 | ESXS-K1 (software) | Version 2.03b 9KHz ~ 30MHz | ROHDE & SCHWARZ | 1082.9678.02 840.913/246 | N/A |

Note : Items 1 ~ 6 were calibrated within period of 1 year.

2 TEST PROCEDURE

- 2.1 The EUT was tested according to **AS/NZS CISPR 22**.
- 2.2 The EUT was placed 0.4 meter from the conducting wall of shielding room and kept at least 0.8 meter from any other grounded conducting surface.
- 2.3 The frequency range form 0.15 MHz to 30 MHz was investigated.
- 2.4 The LISN used was 50 Ohm / 50 uHenry as specified of **AS/NZS CISPR 22**.
- 2.5 All the support peripherals are connect to the other LISN.
- 2.6 Cables and peripherals were moved to find the maximum emission levels for each frequency.

3 TEST SETUP

3.1 Typical : Setup Of Conducted Test

ELECTRICAL AND ELECTRONIC EQUIPMENT IN THE RANGE OF 9kHz TO 40 GHz AS/NZS CISPR 22

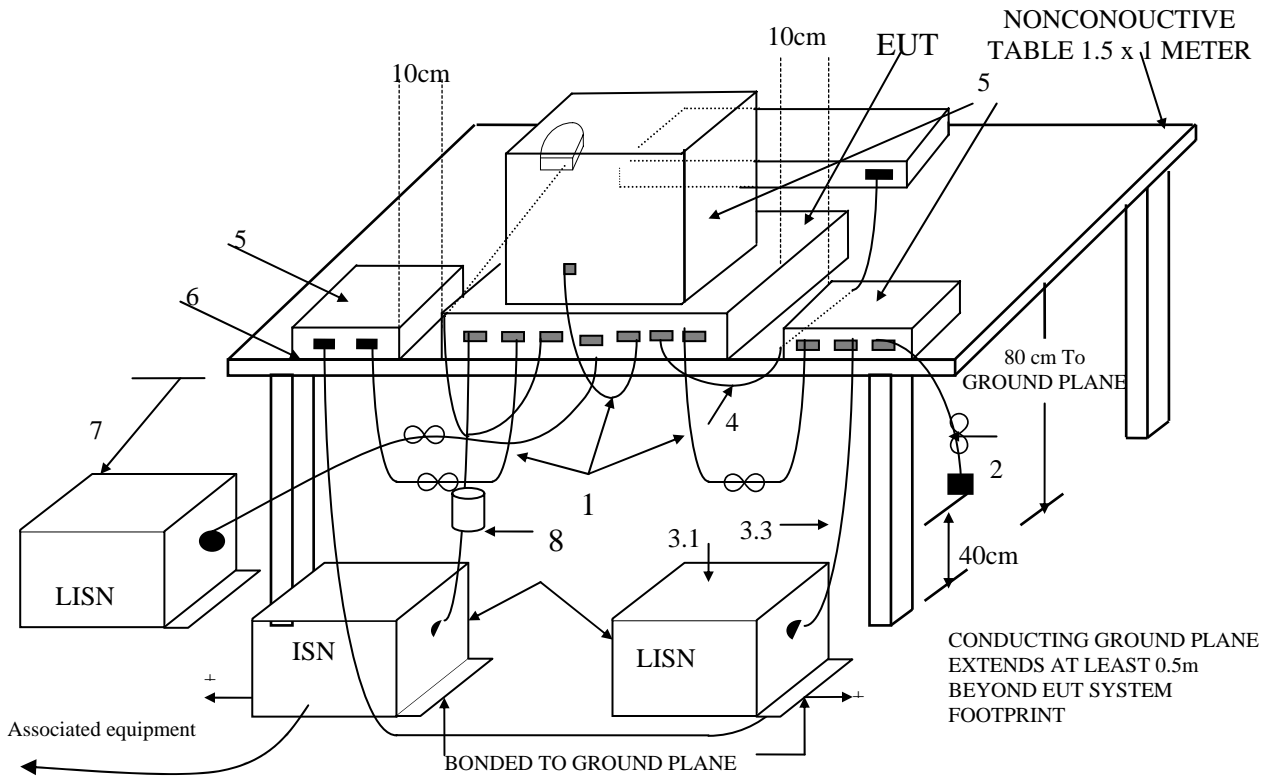

+LISNs may have to be moved to the side to meet 3.3 below.

(Details for setup configuration, please refer to appendix A.)

LEGEND:

1. If cables, which hang closer than 40 cm to the horizontal metal groundplane, cannot be shortened to appropriate length, the excess shall be folded back and forth forming a bundle 30 cm to 40 cm long.
2. Excess mains cord shall be bundled in the centre or shortened to appropriate length.
3. EUT is connected to one artificial mains network (AMN). All AMNs and ISNs may alternatively be connected to a vertical reference plane or metal wall.
 - 3.1 All other units of a system are powered from a second AMN. A multiple outlet strip can be used for multiple mains cords.
 - 3.2 AMN and ISN are 80 cm from the EUT and at least 80 cm from other units and other metal planes.
 - 3.3 Mains cords and signal cables shall be positioned for their entire lengths, as far as possible, at 40 cm from the vertical reference plane.
4. Cables of hand-operated devices, such as keyboards, mice, etc., have to be placed as close as for normal usage.
5. Peripherals shall be placed at a distance of 10 cm from each other and from the controller, except for the monitor which, if this is an acceptable installation practice, shall be placed directly on the top of the controller.
6. I/O signal cable intended for external connection.
7. The end of the I/O signal cables which are not connected to an AE may be terminated, if required, using correct terminating impedance.
8. If used, the current probe shall be placed at 0.1 m from the ISN.

Test Configuration Tabletop Equipment Conducted Emission

3.2 Block Diagram Of Conducted Test

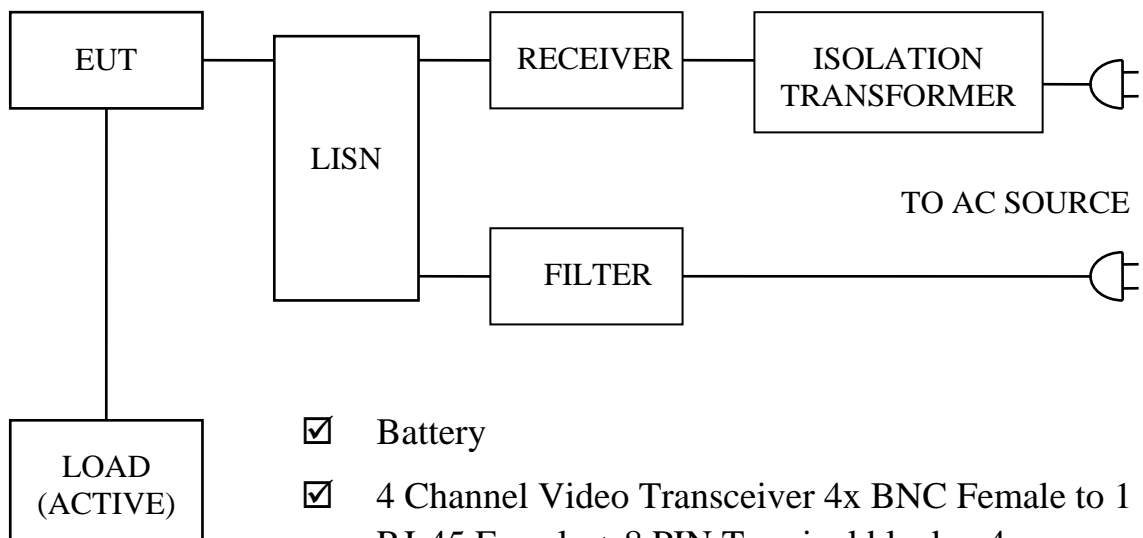

- Battery
- 4 Channel Video Transceiver 4x BNC Female to 1 RJ-45 Female + 8 PIN Terminal block x 4 (TTP414V)
- VIDEO, POWER, DATA COMBINER (TTP111VPD-RJ-45)
- PTZ Transmitter
- PTZ Receiver
- Professional Cable Integrator in 1U Rack Mounting Hub (TDP016)
- CCD Camera
- RS485 Data Repeater (RR01)

4 CONFIGURATION OF THE EUT

The EUT was configured according to **AS/NZS CISPR 22**. All I/O ports were connected to the appropriate peripherals. All peripherals and cables are listed below (including internal device) :

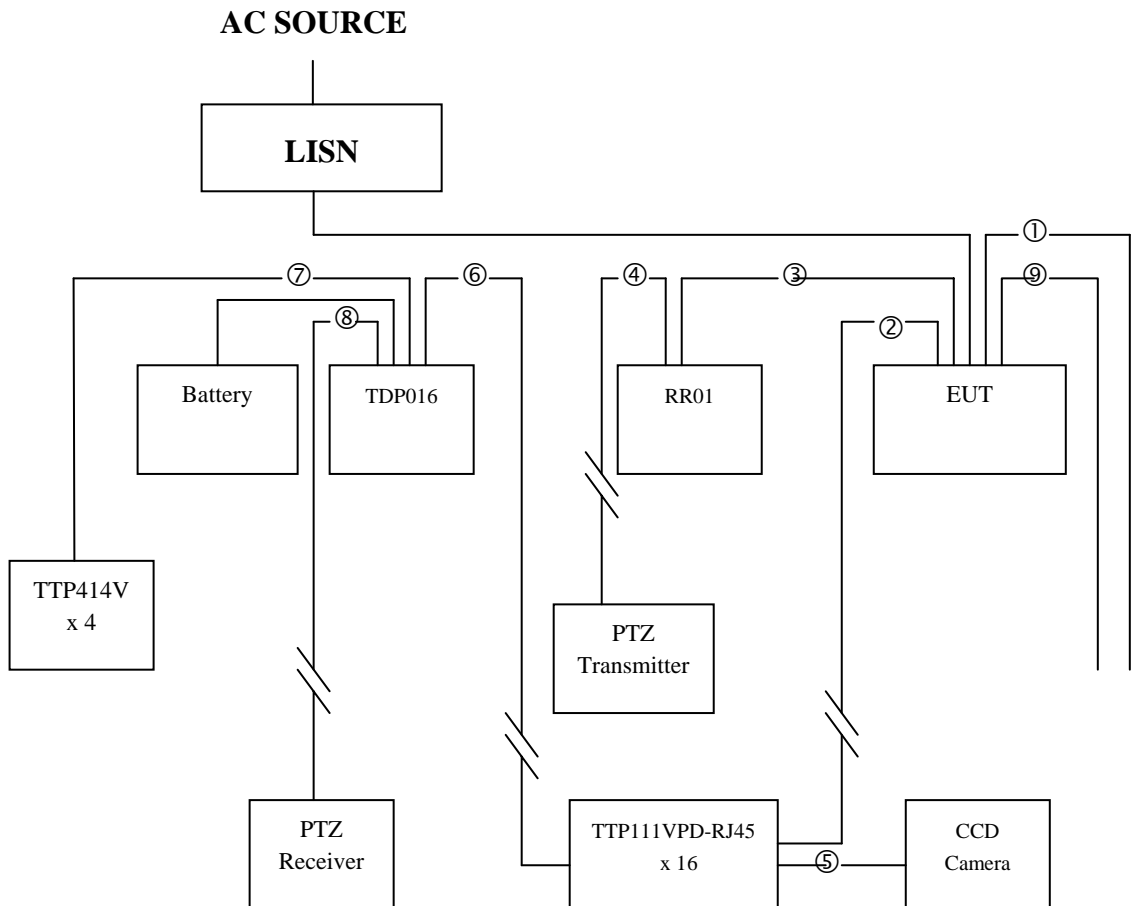

- ① RS-232 Cable Floating
- ② RS-485 Cable x 16
- ③ RS-485 Cable
- ④ RS-485 Cable
- ⑤ Video & Power Cable
- ⑥ RJ-45 Cable x 16
- ⑦ RJ-45 Cable x 4
- ⑧ RS-485 Cable
- ⑨ RS-485 Cable Floating

Figure 1



4.1 EUT

EUT Type : Proto Type Engineer Type Mass Production
Condition when received : Good Damage : _____
Device : Serial Data Distributor 1 In 16 Out In 1U Rack
Mounting Panel
Applicant : Smart Home Engineering Corp.
Manufacturer : Smart Home Engineering Corp.
Model Number : RS0XXX
Serial Number : N/A
FCC ID : N/A
RS-485 Out Port x 16 : Plastic Type Connector
RS-485 In Port : Plastic Type Connector
RS-485 In Cable Floating : Un-Shielded, 1.2 m, Plastic Type Connector
RS-232 Cable Floating : Shielded, 1.8 m, Metal Type Connector
Power Cord (AC) : 2 pin
Power Cord (DC) : Un-Shielded, 1.8 m, 2 pin
Power Supply Type : Linear Adapter

4.2 PERIPHERALS

4 Channel Video Transceiver 4x BNC Female to 1 RJ-45 Female + 8 PIN Terminal block x 4
Manufacturer : SMART CABLING & TRANSMISSION CORP.
Model Number : TTP414V
Serial Number : N/A
FCC ID : N/A
Data Cable x 4 : Un-Shielded, 10 m, Connected to the RJ-45 port
Power Cord : N/A



VIDEO, POWER, DATA COMBINER X 16

Manufacturer : SMART CABLING & TRANSMISSION CORP.
Model Number : TTP111VPD-RJ45
Serial Number : N/A
FCC ID : N/A
Data Cable : Un-Shielded, 10 m, Connected to the RJ-45 port
Power Cord & Adaptor : N/A

RS485 Data Repeater

Manufacturer : Smart Home Engineering Corp.
Model Number : RR01
Serial Number : N/A
FCC ID : N/A
Data Cable : Un-Shielded, 10 m, Connected to the RS-485 In port
Power Cord & Adaptor : Un-Shielded, 1.8 m

Professional Cable Integrator in 1U Rack Mounting Hub

Manufacturer : SMART CABLING & TRANSMISSION CORP.
Model Number : TDP016
Serial Number : N/A
FCC ID : N/A
Data Cable 1 x 20 : Un-Shielded, 10 m, Connected to the RJ-45 port
Data Cable 2 : Un-Shielded, 10 m, Connected to the RS-485 port
Power Cord (DC) : Un-Shielded, 10 m



PTZ Transmitter

Manufacturer : SMART CABLING & TRANSMISSION CORP.
Model Number : PCT017
Serial Number : N/A
FCC ID : N/A
Data Cable : Un-Shielded, 10 m, Connected to the RS-485 port
Power Cord (DC) : Un-Shielded, 1.8 m

PTZ Receiver

Manufacturer : SMART CABLING & TRANSMISSION CORP.
Model Number : PCR011
Serial Number : N/A
FCC ID : N/A
Data Cable : Un-Shielded, 10 m, Connected to the RS-485 port
Power Cord (DC) : Un-Shielded, 1.8 m

CCD Camera

Manufacturer : Comedar
Model Number : CM-930
Serial Number : N/A
FCC ID : N/A
Data Cable : Un-Shielded, 0.3 m, Connected to the Video port
Power Cord (DC) : Un-Shielded, 0.3 m



Battery

Manufacturer : YUASA
Model Number : 80D26L-CMFII
Serial Number : N/A
FCC ID : N/A
Data Cable : N/A
Power Cord (DC) : N/A

Power Adapter

Manufacturer : Atech
Model Number : ADP12500N-2
Serial Number : N/A
FCC ID : N/A
Data Cable : N/A
Power Cord (DC) : Un-Shielded, 1.8 m

4.3 REMARK : N/A

5 EUT OPERATING CONDITION

5.1 The frequency of the EUT is none.

5.2 Configure the EUT according to the **AS/NZS CISPR 22**.

5.3

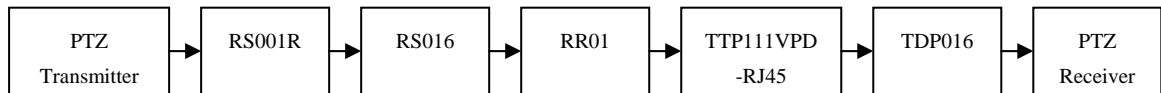

5.4 PTZ Transmitter send RS-485 signal to RS001, RS016, TTP111VPD-RJ45, TDP016, and RR01, RS016, TTP111VPD-RJ45 change RS-485 signal.

5.5 Then has changed RS-485 signal send to PTZ Receiver.

5.6 Measure the maximum emission noise.

5.7 The photos of conducted test configuration, please refer to appendix A.

6 LIMIT OF CONDUCTED POWER LINE EMISSION CLASS B

AS/NZS CISPR 22

| Frequency Range | Quasi Peak | Average |
|-----------------|--------------|--------------|
| 0.15 ~ 0.5 MHz | 66 - 56 dBuV | 56 - 46 dBuV |
| 0.5 ~ 5 MHz | 56 dBuV | 46 dBuV |
| 5 ~ 30 MHz | 60 dBuV | 50 dBuV |

6.1 In the above table, the tighter limit applies at the band edges.

7 RESULT OF CONDUCTED POWER LINE TEST

7.1 The frequency range from 0.15 MHz to 30 MHz was investigated. All readings are quasi-peak values and average.

7.2 IF bandwidth : 9 kHz, Meas Time : 1 sec.

7.3 Temperature : 23 °C, Humidity : 52 % RH.

7.4 Uncertainty in conducted emission measurement : ± 2.90dB.

7.5 The conducted test result were gained by following procedures :

Level = Reading Level + Insertion Loss of LISN + Cable Loss

(All calculation were done by ESHS30 EMI test receiver.)

7.6 Result : **PASSED**

8 CONDUCTED POWER LINE TEST DATA (PAGE 1)

HomeTek EMC LAB. TEL :886-2-22608375

15 May 2007 17:20

CONDUCTED EMISSIONS

EUT: Serial Data Distributor 1 In 16 Out In 1U Rack Mounting Panel
 Manuf: 6E017
 Op Cond: LINE 1
 Operator: Mello
 Test Spec: FOR CISPR22 CLASS B
 Comment: 240V/50Hz
 RS016
 Result File: 6e01711g.dat :

Prescan Measurement: Detectors: X PK / + AV
 Meas Time: see scan settings
 Subranges: 16
 Acc Margin: 55 dB

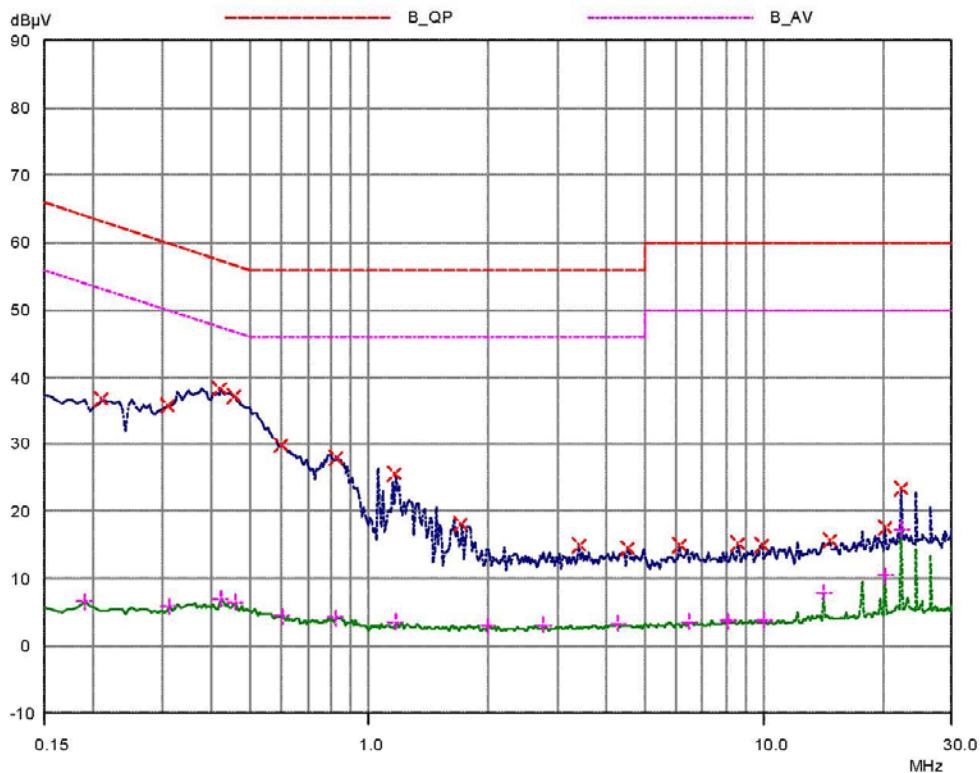



9 CONDUCTED POWER LINE TEST DATA (PAGE 2)

HomeTek EMC LAB. TEL :886-2-22608375

15 May 2007 17:20

CONDUCTED EMISSIONS

EUT: Serial Data Distributor 1 In 16 Out In 1U Rack Mounting Panel
 Manuf: 6E017
 Op Cond: LINE 1
 Operator: Mello
 Test Spec: FOR CISPR22 CLASS B
 Comment: 240V/50Hz
 RS016
 Result File: 6e01711g.dat :

Prescan Measurement: Detectors: X PK / + AV
 Meas Time: see scan settings
 Subranges: 16
 Acc Margin: 55 dB

Peak Search Results

| Frequency MHz | PK Level dBµV | PK Limit dBµV | PK Delta dB |
|------------------|------------------|------------------|----------------|
| 0.21 | 36.73 | 63.21 | 26.48 |
| 0.31 | 35.78 | 59.97 | 24.19 |
| 0.42 | 38.37 | 57.45 | 19.08 |
| 0.455 | 37.24 | 56.78 | 19.54 |
| 0.6 | 29.73 | 56.00 | 26.27 |
| 0.828 | 27.96 | 56.00 | 28.04 |
| 1.164 | 25.52 | 56.00 | 30.48 |
| 1.71 | 18.13 | 56.00 | 37.87 |
| 3.39 | 14.91 | 56.00 | 41.09 |
| 4.51 | 14.43 | 56.00 | 41.57 |
| 6.11 | 14.84 | 60.00 | 45.16 |
| 8.56 | 15.18 | 60.00 | 44.82 |
| 9.9 | 14.99 | 60.00 | 45.01 |
| 14.7 | 15.60 | 60.00 | 44.40 |
| 20.23 | 17.61 | 60.00 | 42.39 |
| 22.25 | 23.46 | 60.00 | 36.54 |

| Frequency MHz | AV Level dBµV | AV Limit dBµV | AV Delta dB |
|------------------|------------------|------------------|----------------|
| 0.19 | 6.54 | 54.04 | 47.50 |
| 0.31 | 5.89 | 49.97 | 44.08 |
| 0.42 | 6.93 | 47.45 | 40.52 |
| 0.455 | 6.46 | 46.78 | 40.32 |
| 0.6 | 4.39 | 46.00 | 41.61 |
| 0.821 | 4.23 | 46.00 | 41.77 |
| 1.164 | 3.56 | 46.00 | 42.44 |
| 1.99 | 2.97 | 46.00 | 43.03 |
| 2.746 | 3.12 | 46.00 | 42.88 |
| 4.237 | 3.30 | 46.00 | 42.70 |
| 6.45 | 3.62 | 50.00 | 46.38 |
| 8.10999 | 3.70 | 50.00 | 46.30 |
| 9.94 | 3.83 | 50.00 | 46.17 |
| 14.19 | 7.87 | 50.00 | 42.13 |
| 20.23 | 10.43 | 50.00 | 39.57 |
| 22.25 | 17.23 | 50.00 | 32.77 |

* limit exceeded

10 CONDUCTED POWER LINE TEST DATA (PAGE 3)

HomeTek EMC LAB. TEL :886-2-22608375

15 May 2007 17:29

CONDUCTED EMISSIONS

EUT: Serial Data Distributor 1 In 16 Out In 1U Rack Mounting Panel
 Manuf: 6E017
 Op Cond: LINE 2
 Operator: Mello
 Test Spec: FOR CISPR22 CLASS B
 Comment: 240V/50Hz
 RS016
 Result File: 6e01721g.dat :

Prescan Measurement: Detectors: X PK / + AV
 Meas Time: see scan settings
 Subranges: 16
 Acc Margin: 55 dB

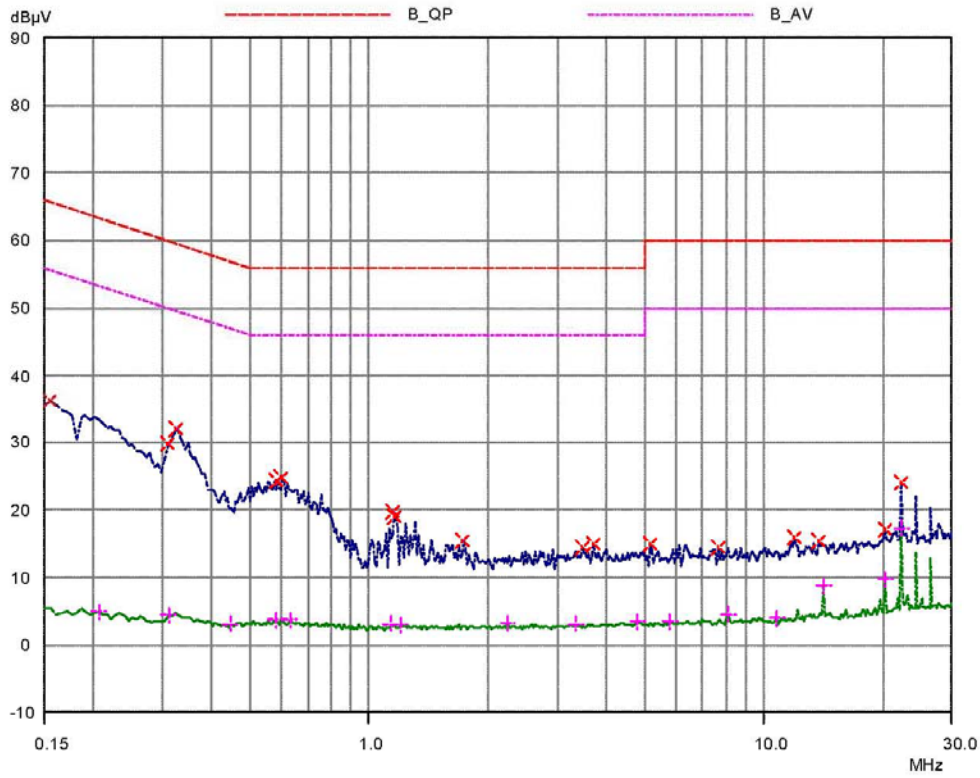



11 CONDUCTED POWER LINE TEST DATA (PAGE 4)

HomeTek EMC LAB. TEL :886-2-22608375

15 May 2007 17:29

CONDUCTED EMISSIONS

EUT: Serial Data Distributor 1 In 16 Out In 1U Rack Mounting Panel
 Manuf: 6E017
 Op Cond: LINE 2
 Operator: Mello
 Test Spec: FOR CISPR22 CLASS B
 Comment: 240V/50Hz
 RS016
 Result File: 6e01721g.dat :

Prescan Measurement: Detectors: X PK / + AV
 Meas Time: see scan settings
 Subranges: 16
 Acc Margin: 55 dB

Peak Search Results

| Frequency MHz | PK Level dBµV | PK Limit dBµV | PK Delta dB |
|------------------|------------------|------------------|----------------|
| 0.155 | 36.32 | 65.73 | 29.41 |
| 0.31 | 29.75 | 59.97 | 30.22 |
| 0.325 | 32.11 | 59.58 | 27.47 |
| 0.585 | 24.40 | 56.00 | 31.60 |
| 0.6 | 24.72 | 56.00 | 31.28 |
| 1.15 | 19.67 | 56.00 | 36.33 |
| 1.164 | 19.04 | 56.00 | 36.96 |
| 1.738 | 15.51 | 56.00 | 40.49 |
| 3.446 | 14.53 | 56.00 | 41.47 |
| 3.677 | 14.84 | 56.00 | 41.16 |
| 5.15 | 14.91 | 60.00 | 45.09 |
| 7.64 | 14.38 | 60.00 | 45.62 |
| 11.9 | 15.88 | 60.00 | 44.12 |
| 13.7 | 15.42 | 60.00 | 44.58 |
| 20.23 | 17.15 | 60.00 | 42.85 |
| 22.25 | 23.96 | 60.00 | 36.04 |

| Frequency MHz | AV Level dBµV | AV Limit dBµV | AV Delta dB |
|------------------|------------------|------------------|----------------|
| 0.205 | 4.95 | 53.41 | 48.46 |
| 0.31 | 4.44 | 49.97 | 45.53 |
| 0.445 | 3.13 | 46.97 | 43.84 |
| 0.58 | 3.75 | 46.00 | 42.25 |
| 0.63 | 3.68 | 46.00 | 42.32 |
| 1.129 | 3.07 | 46.00 | 42.93 |
| 1.199 | 2.97 | 46.00 | 43.03 |
| 2.228 | 3.23 | 46.00 | 42.77 |
| 3.327 | 3.11 | 46.00 | 42.89 |
| 4.769 | 3.50 | 46.00 | 42.50 |
| 5.77 | 3.48 | 50.00 | 46.52 |
| 8.10999 | 4.59 | 50.00 | 45.41 |
| 10.73 | 3.95 | 50.00 | 46.05 |
| 14.19 | 8.71 | 50.00 | 41.29 |
| 20.23 | 9.67 | 50.00 | 40.33 |
| 22.25 | 17.34 | 50.00 | 32.66 |

* limit exceeded

RADIATED EMISSION TEST

1 TEST INSTRUMENTS & FACILITIES

The following test Instruments was used during the radiated emission test :

| Item | Instruments /facilities | Specification | Manufacturer | Model # / S/N# | Date of Cal. |
|------|-------------------------|--|-----------------|------------------------|--------------|
| 1 | OPEN AREA TEST SITE | <input checked="" type="checkbox"/> OATS 3 | | | JUL/2006 |
| 2 | EMI TEST RECEIVER | 20Hz ~ 26.5GHz | ROHDE & SCHWARZ | ESMI 845442/006 | FEB/2007 |
| 3 | PRE-AMPLIFIER | 9KHz ~ 3000MHz | ADVANTEST | BB525C 90081001 | OCT/2006 |
| 4 | ANTENNA (BI-LOG) | 25MHz ~ 2GHz | SCHAFFNER | CBL6112B S/N : 2614 | JUN/2006 |
| 5 | Attenuation | 50Ω/6dB | JYE BAO | FAT-N (M-F) 001 | JUL/2006 |
| 6 | Ferrite Clamp | 30 ~ 1000MHz | ADT | FC18 910030 | DEC/2006 |
| 7 | Ferrite Clamp | 30 ~ 1000MHz | HomeTek | HFC 001 | DEC/2006 |
| 8 | Cable | 10m | SUHNER | RG214/U OS3-003 | DEC/2006 |
| 9 | Cable | 14m | BELDEN | 9913 OS3-001 | DEC/2006 |
| 10 | EMI 32 (software) | N/A | AUDIX | 19991013-0923 | N/A |

Note : Items 1 ~ 9 were calibrated within period of 1 year.

2 TEST PROCEDURE

- 2.1 The EUT was test according to **AS/NZS CISPR 22**.
- 2.2 The radiated test was performed at HomeTek Lab's Open Site 3.
- 2.3 The frequency range from 30 MHz to 1 GHz, the measurement were made at 10 meters, with a BI-log antenna.

3 TEST SETUP

3.1 TEST SETUP OF OPEN SITE.

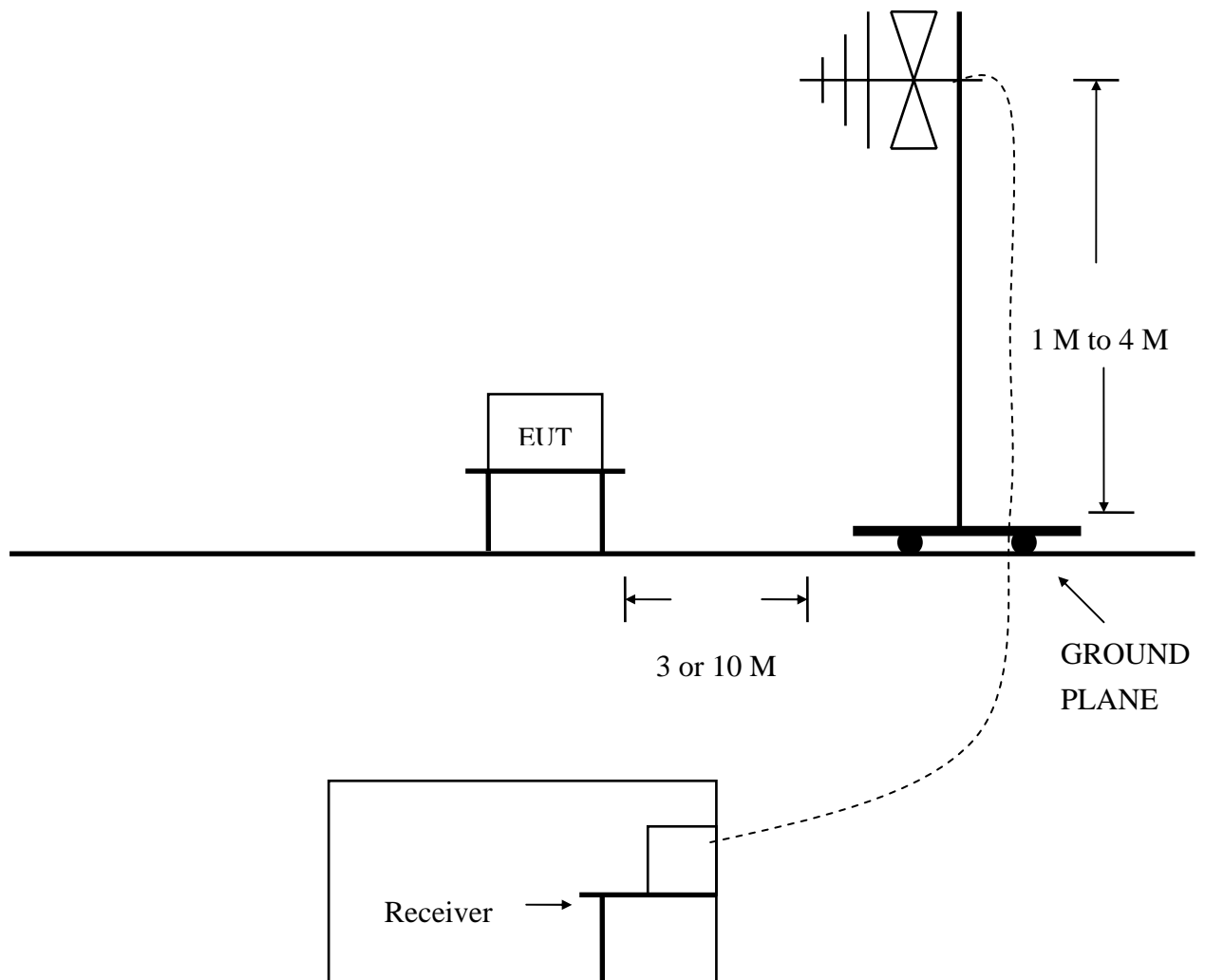

3.2 TEST SETUP OF EUT

ELECTRICAL AND ELECTRONIC EQUIPMENT IN THE RANGE OF 9kHz TO 40 GHz AS
 NZS CISPR 22

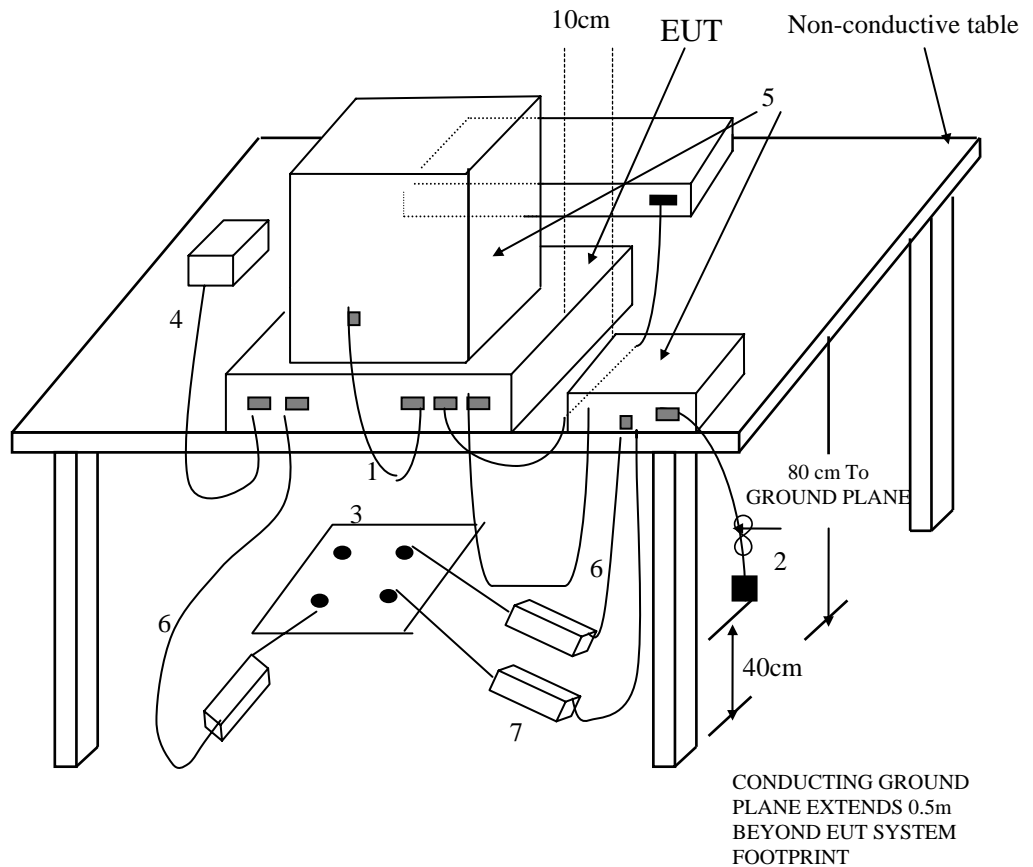

(Details for setup configuration, please refer to appendix A.)

LEGEND:

1. If cables, which hang closer than 40 cm to the horizontal metal ground plane cannot be shortened to the appropriate length, the excess shall be folded back and forth forming a bundle 30 cm to 40 cm long.
2. The end of I/O signal cables which are not connected to a peripheral may be terminated, if required for proper operation using correct terminating impedance.
3. Mains junction box(es) shall be flush with, and bonded directly to, the metal ground plane.
 NOTE if used, the AMN shall be installed under the horizontal metal ground plane.
4. Cables of hand-operated devices such as keyboards, mouses, etc. shall be placed as for normal usage.
5. Peripherals shall be placed at a distance of 10 cm from each other and from the controller, except for the monitor which, if for an acceptable installation practice, shall be placed directly on top of the controller.
6. Mains cables, telephone lines or other connections to auxiliary equipment located outside the test area shall drape to the floor, be fitted with ferrite clamps or ferrite tubes placed on the floor at the point where the cable reaches the floor and then routed to the place where they leave the turntable. No extension cords shall be used to mains receptacle.
7. Ferrite clamps or ferrite tubes with similar characteristics (as defined in 10.4). No more than one cable per clamp.

**Test Configuration
 Tabletop Equipment Radiated Emission**

4 **CONFIGURATION OF THE EUT**
Same as “Conducted Power Line test”, section 5

5 **EUT OPERATING CONDITION**

5.1 Same as “Conducted Power Line test”, section 5

5.2 The radiated emission in the frequency range from 30 MHz - 1000 MHz was test in a horizontal and vertical polarization at HomeTek Lab’s open site 3.

5.3 The photos of radiated test configuration, please refer to appendix A.

6 **LIMIT OF RADIATED EMISSION CLASS B**

AS/NZS CISPR 22

| Frequency (MHz) | Measurement Distance | Limit (dBuV/m) |
|-----------------|----------------------|----------------|
| 30 - 230 | 10 (M) | 30 |
| 230 - 1000 | 10 (M) | 37 |

6.1 The tighter limit shall apply at the edge between two frequency bands.

6.2 Measurement distance in meters between the measuring instrument antenna and the closed point of any part of the EUT or peripherals.

7 **RESULT OF RADIATED EMISSION TEST**

7.1 The frequency range from 30 MHz to 1 GHz was investigated.

7.2 All readings below or equal 1 GHz are quasi-peak or peak values with resolution bandwidth of 120 KHz.

7.3 The measurements were made at 10 meters of HomeTek Lab’s open site 3.

7.4 Temperature : 21 °C, Humidity : 62 % RH.

7.5 Uncertainty in radiated emission measurement : ± 4.18dB.

7.6 The radiated emission result were gained by the following method :

Level = Reading Level + Probe Factor (Antenna Factor) + Cable Loss – Preamp Factor

Over Limit = Level – Limit Line

7.7 Result : **PASSED**



8 RADIATED EMISSION TEST DATA (PAGE 1)



HomeTek Technology Inc.

No 67-9, Shi-Men Rd., Tu-Chen City,
Taipei County, Taiwan R.O.C.
Tel: 02-22608375
Fax: 02-22748013

Data#: 6 File#: 6e017.emi

Date: 2007-05-18 Time: 19:22:34

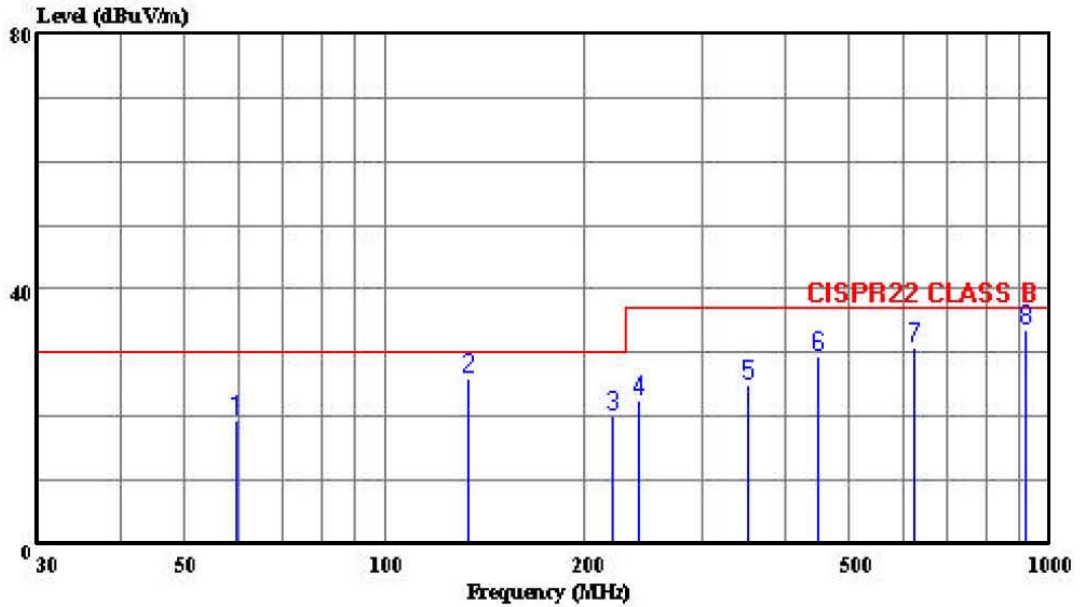

Trace:

Ref Trace:

Condition: CISPR22 CLASS B 10m CHASE 2614 060506 HORIZONTAL
 eut : Serial Data Distributor 1 In 16 Out In 1U Rack Mounting Panel
 power: 240V/50Hz
 memo : RS016

Page: 1

| Peak | Freq MHz | Level dBUV/m | Limit dBUV/m | Over Limit dB | ReadAntenna Level dBuV | Cable Factor dB/m | Preamp Loss dB | Remark |
|------|-------------|-----------------|-----------------|---------------------|------------------------------|-------------------------|----------------------|------------|
| 1 | 59.811 | 19.27 | 30.00 | -10.73 | 37.30 | 6.99 | 0.94 | 25.96 Peak |
| 2 | 133.489 | 26.06 | 30.00 | -3.94 | 38.70 | 11.46 | 1.73 | 25.83 Peak |
| 3 | 220.127 | 20.08 | 30.00 | -9.92 | 34.25 | 9.23 | 2.27 | 25.67 Peak |
| 4 | 241.157 | 22.61 | 37.00 | -14.39 | 34.27 | 11.55 | 2.41 | 25.62 Peak |
| 5 | 351.937 | 24.78 | 37.00 | -12.22 | 32.57 | 14.47 | 3.09 | 25.35 Peak |
| 6 | 446.686 | 29.36 | 37.00 | -7.64 | 34.22 | 16.54 | 3.63 | 25.03 Peak |
| 7 | 623.391 | 30.96 | 37.00 | -6.04 | 30.90 | 18.73 | 5.69 | 24.37 Peak |
| 8 | 919.603 | 33.60 | 37.00 | -3.40 | 31.35 | 20.51 | 5.13 | 23.39 Peak |



9 RADIATED EMISSION TEST DATA (PAGE 2)



HomeTek Technology Inc.

No 67-9, Shi-Men Rd., Tu-Chen City, Taipei County, Taiwan R.O.C. Tel:02-22608375 Fax:02-22748013

Data#: 5 File#: 6e017.emi

Date: 2007-05-18 Time: 14:43:31

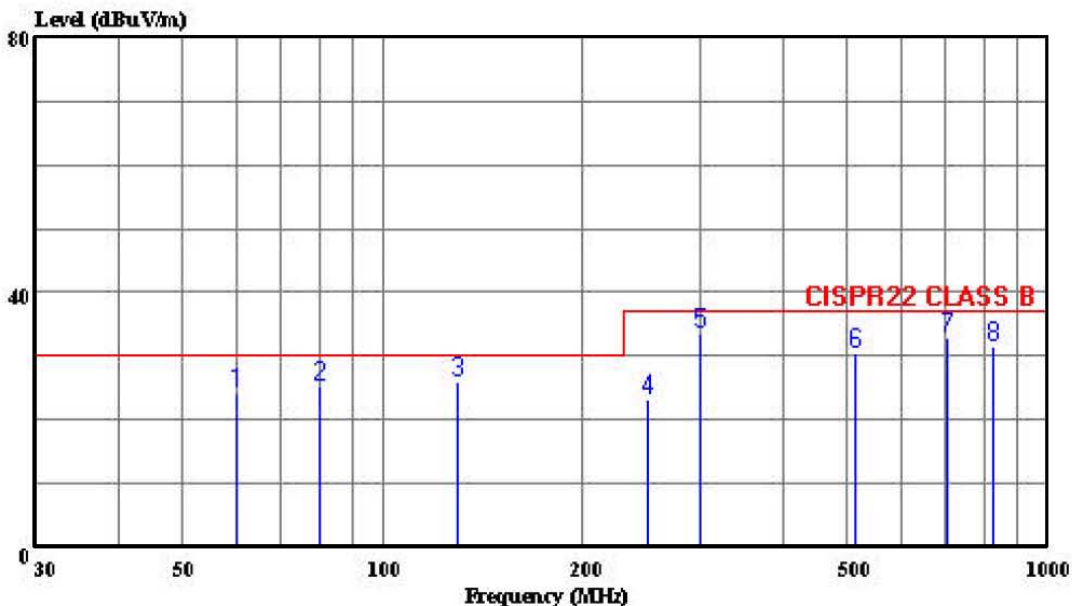

Trace:

Ref Trace:

Condition: CISPR22 CLASS B 10m CHASE 2614 060506 VERTICAL
eut : Serial Data Distributor 1 In 16 Out In 1U Rack Mounting Panel
power: 240V/50Hz
memo : RS016

Page: 1

| Peak | Freq | Level | Limit | Over | ReadAntenna | Cable | Preamp | Remark |
|------|---------|--------|--------|--------|-------------|--------|--------|------------|
| | MHz | dBuV/m | dBuV/m | dB | Level | Loss | Factor | |
| | | | | | Factor | Factor | | |
| | | | | | dB/m | dB | dB | |
| 1 | 60.137 | 24.28 | 30.00 | -5.72 | 42.32 | 6.97 | 0.94 | 25.95 Peak |
| 2 | 80.137 | 25.21 | 30.00 | -4.79 | 42.70 | 7.21 | 1.23 | 25.93 Peak |
| 3 | 129.432 | 25.84 | 30.00 | -4.16 | 38.45 | 11.54 | 1.70 | 25.84 Peak |
| 4 | 250.214 | 23.19 | 37.00 | -13.81 | 34.02 | 12.30 | 2.47 | 25.60 Peak |
| 5 | 300.007 | 33.50 | 37.00 | -3.50 | 43.10 | 13.13 | 2.77 | 25.50 Peak |
| 6 | 513.036 | 30.35 | 37.00 | -6.65 | 33.17 | 17.74 | 4.21 | 24.77 Peak |
| 7 | 704.036 | 32.95 | 37.00 | -4.05 | 32.97 | 18.87 | 5.13 | 24.02 Peak |
| 8 | 827.036 | 31.38 | 37.00 | -5.62 | 29.90 | 20.04 | 5.13 | 23.68 Peak |



HomeTek Technology Inc.

Appendix A

PHOTOS OF TEST CONFIGURATION

PHOTO OF CONDUCTED POWER LINE TEST

Model : RS016



Front View



Rear View

PHOTO OF RADIATED EMISSION TEST

Model : RS016

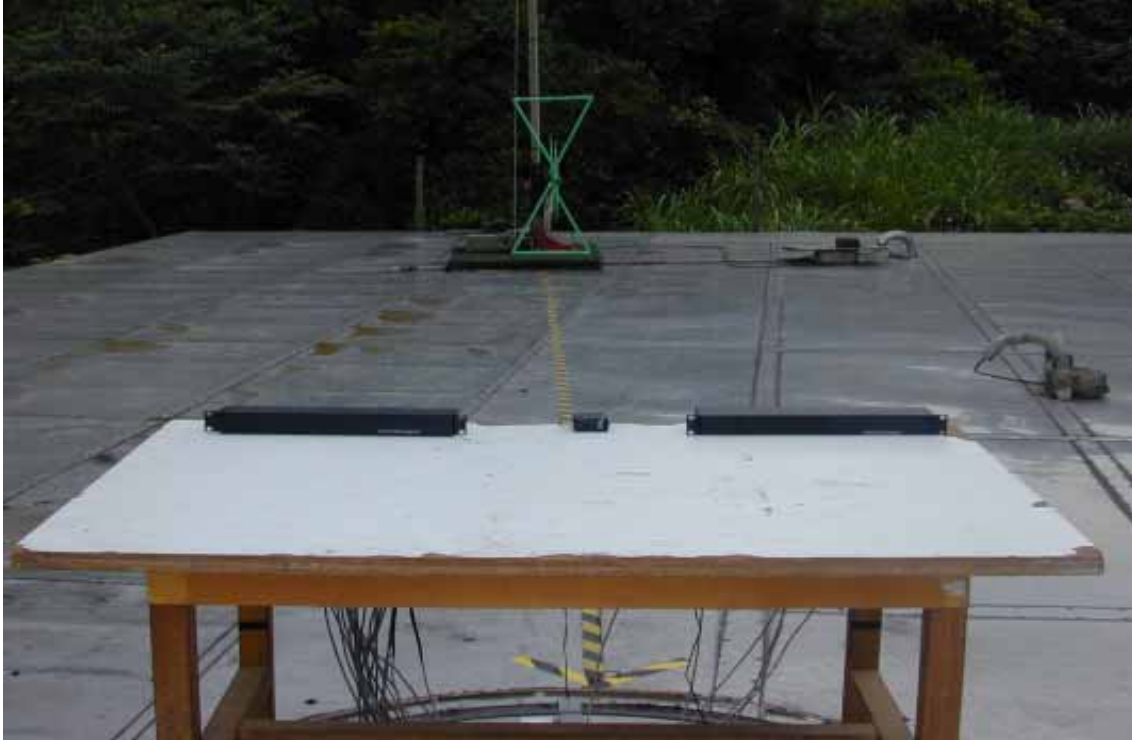

Front View



Rear View



HomeTek Technology Inc.

Appendix B

PHOTOS OF EUT

PHOTO OF EUT

Model : RS0XXX



Full View of EUT

PHOTO OF EUT

Model : RS0XXX

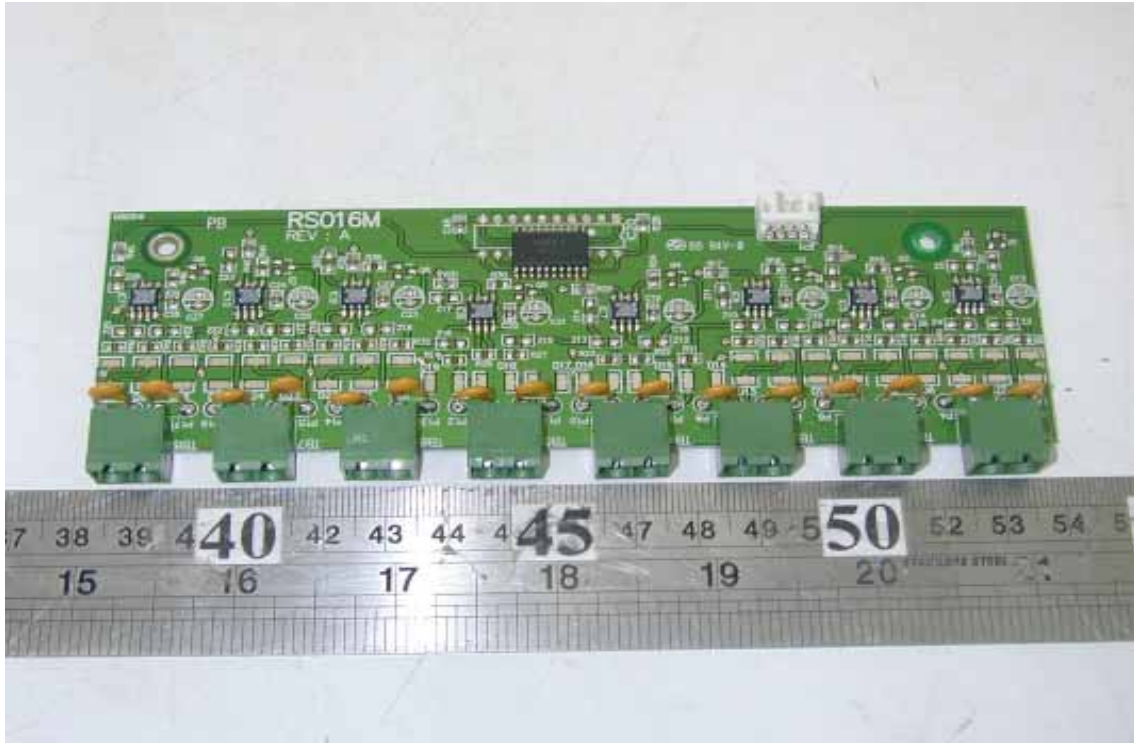

Component Side of Main Board 1

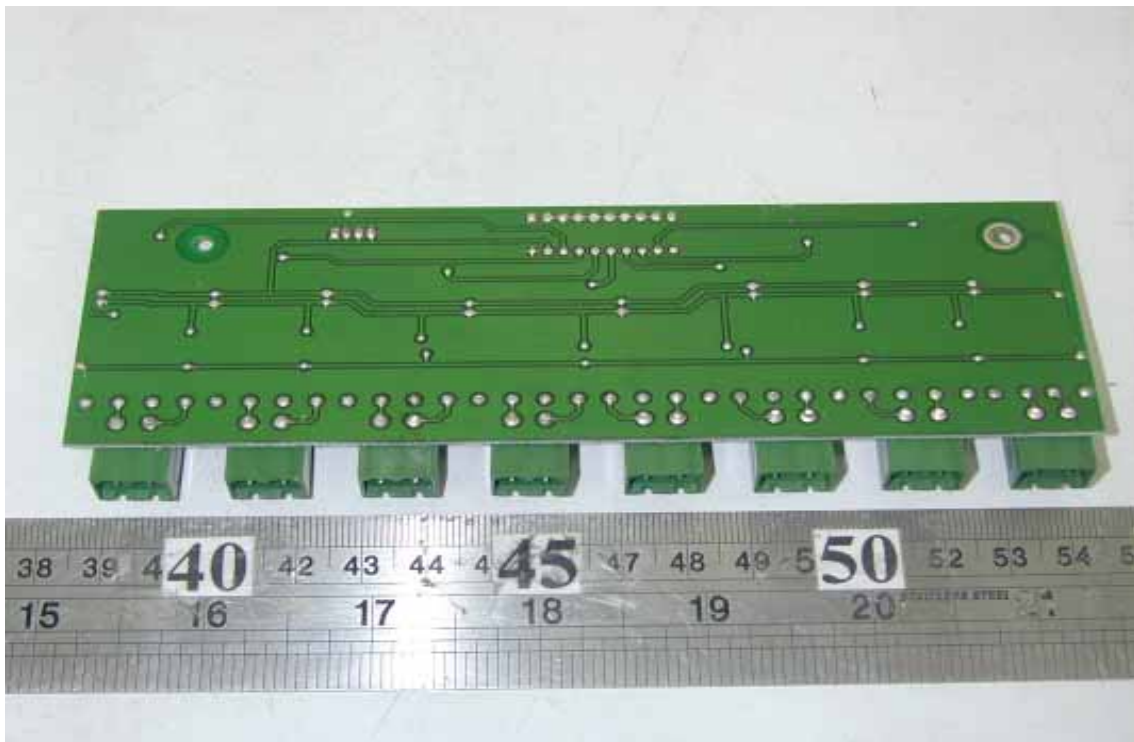

Solder Side of Main Board 1

PHOTO OF EUT

Model : RS0XXX



Component Side of Main Board 2

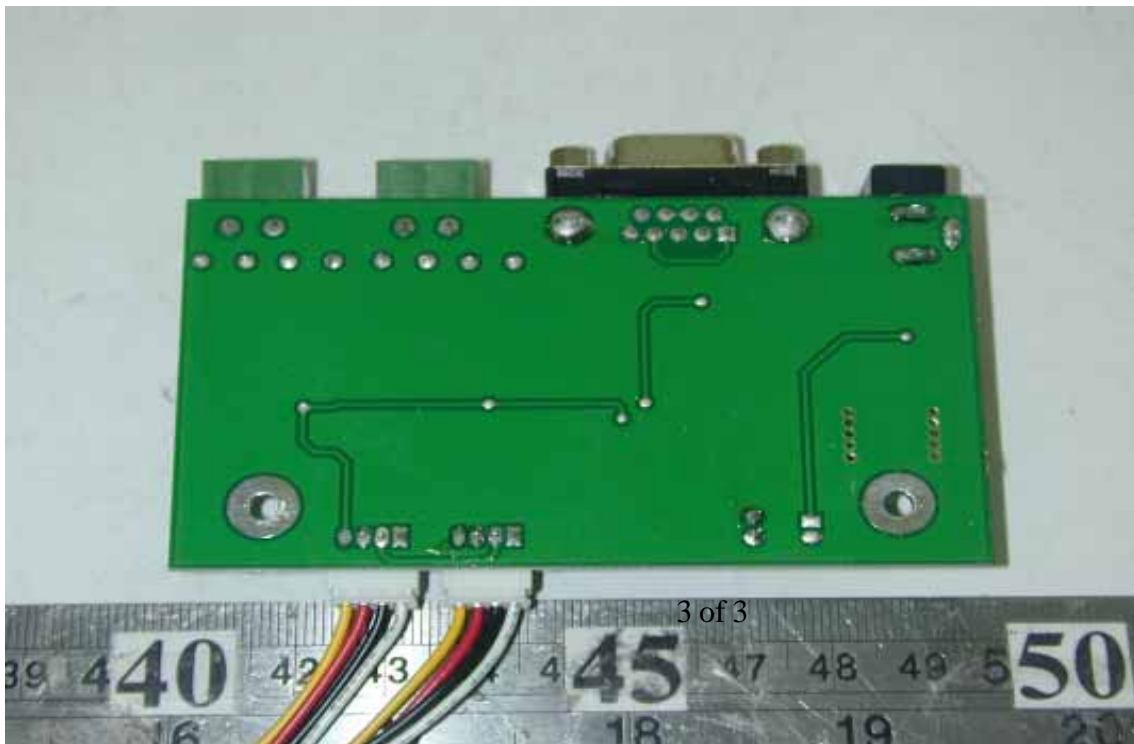

Solder Side of Main Board 2

PHOTO OF EUT



Front View of Adapter (Model: ADP12500N-2)



Rear View of Adapter (Model: ADP12500N-2)

Declaration of Conformity

Responsible Party Name :

Address :

Phone No :

Fax No :

Declares under our sole responsibility that the product

Product Name : Serial Data Distributor 1 In 16 Out In 1U
Rack Mounting Panel

Model No. : RS0XXX

to which this declaration relates is in conformity with the following standards or other
normative documents

AS/NZS CISPR 22 (2004) : Electromagnetic Interference
– Limits and Methods of Measurement of Information Technology Equipment

Representative Person's Name : _____

Signature : _____

Date : _____

United States Department of Commerce
National Institute of Standards and Technology

NVLAP[®]

Certificate of Accreditation to ISO/IEC 17025:2005

NVLAP LAB CODE: 200331-0

HomeTek Technology Inc.

Taipei Shien 236
TAIWAN

is recognized by the National Voluntary Laboratory Accreditation Program for conformance with criteria set forth in
NVLAP accreditation documents and all requirements of ISO/IEC 17025:2005.
Accreditation is granted for specific services, listed on the Scope of Accreditation, for:

ELECTROMAGNETIC COMPATIBILITY AND TELECOMMUNICATIONS

2006-10-01 through 2007-09-30

Effective dates

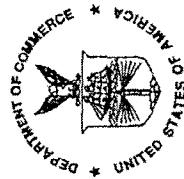

Dally A. Bruce

For the National Institute of Standards and Technology



**National Voluntary
Laboratory Accreditation Program**



SCOPE OF ACCREDITATION TO ISO/IEC 17025:2005

HomeTek Technology Inc.
P.O Box: 13-131, Pan-Chiao City
No. 67-9 Shir Men Rd., Tu Chen City
Taipei Shien 236
TAIWAN
Mr. Grant Huang
Phone: 886-2-22608375 Fax: 886-2-22748013
E-Mail: hometek@ms15.hinet.net

**ELECTROMAGNETIC COMPATIBILITY
AND TELECOMMUNICATIONS**

NVLAP LAB CODE 200331-0

NVLAP Code Designation / Description

Emissions Test Methods:

| | |
|------------|--|
| 12/CIS14a | EN 55014-1 (1993), A1 (1997), A2 (1999): |
| 12/CIS14a2 | BS EN 55014-1 (2001) with A1 and A2: Electromagnetic compatibility - Requirements for household appliances, electric tools and similar apparatus - Part 1: Emission |
| 12/CIS14b1 | AS/NZS CISPR 14-1 (2003): Electromagnetic Compatibility - Requirements for household appliances, electric tools and similar apparatus - Part 1: Emission |
| 12/CIS14c | CNS 13783-1: Electromagnetic Compatibility Requirements for household appliances, electric tools and similar apparatus - Part 1: Emissions |
| 12/CIS14d | IEC/CISPR 14-1 (2001) and A1 (2001): Electromagnetic Compatibility - Requirements for household appliances, electric tools and similar apparatus - Part 1: Emissions |
| 12/CIS14x | IEC/CISPR 14-1, Ed. 4 (2003): Electromagnetic Compatibility - Requirements for household appliances, electric tools and similar apparatus - Part 1: Emission |
| 12/CIS22 | IEC/CISPR 22 (1997) & EN 55022 (1998) + A1(2000): Limits and methods of measurement of radio disturbance characteristics of information technology equipment |

2006-10-01 through 2007-09-30

Effective dates

Sally A. Bruce
For the National Institute of Standards and Technology



**National Voluntary
Laboratory Accreditation Program**



**ELECTROMAGNETIC COMPATIBILITY
AND TELECOMMUNICATIONS**

NVLAP LAB CODE 200331-0

| <i>NVLAP Code</i> | <i>Designation / Description</i> |
|-------------------|--|
| 12/CIS22a | IEC/CISPR 22 (1993) and EN 55022 (1994): Limits and methods of measurement of radio disturbance characteristics of information technology equipment, Amendment 1 (1995) and Amendment 2 (1996) |
| 12/CIS22b | CNS 13438 (1997): Limits and Methods of Measurement of Radio Interference Characteristics of Information Technology Equipment |
| 12/CIS22c | IEC/CISPR 22, Fourth Edition (2003-04) & EN 55022 (1998): Information technology equipment - Radio disturbance characteristics - Limits and methods of measurement |
| 12/FCC15b | ANSI C63.4 (2003) with FCC Method 47 CFR Part 15, Subpart B: Unintentional Radiators |
| 12/T51a | AS/NZS CISPR 22 (2004): Information technology equipment - Radio disturbance characteristics - Limits and methods of measurement |
| 12/VCCIa | VCCI: Agreement of Voluntary Control Council for Interference by Information Technology Equipment - Technical Requirements: V-3/2005.04 |

2006-10-01 through 2007-09-30

Effective dates

For the National Institute of Standards and Technology

United States Department of Commerce
National Institute of Standards and Technology

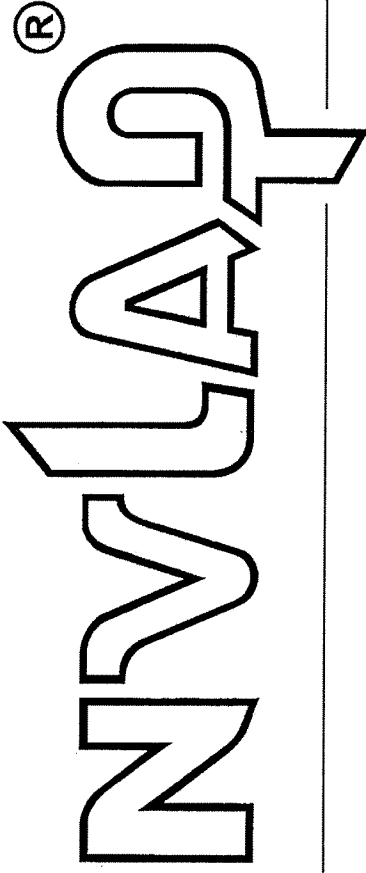

Certificate of Accreditation to ISO/IEC 17025:2005

NVLAP LAB CODE: 200331-0

HomeTek Technology Inc.

Taipei Shien 236

TAIWAN

is accredited by the National Voluntary Laboratory Accreditation Program for specific services,
listed on the Scope of Accreditation, for:

ELECTROMAGNETIC COMPATIBILITY AND TELECOMMUNICATIONS

*This laboratory is accredited in accordance with the recognized International Standard ISO/IEC 17025:2005.
This accreditation demonstrates technical competence for a defined scope and the operation of a laboratory quality
management system (refer to joint ISO-ILAC-IAF Communique dated 18 June 2005).*

2007-10-01 through 2008-09-30

Effective dates



Jolly S. Buce

For the National Institute of Standards and Technology



SCOPE OF ACCREDITATION TO ISO/IEC 17025:2005

HomeTek Technology Inc.

P.O Box: 13-131, Pan-Chiao City
No. 67-9 Shir Men Rd., Tu Chen City
Taipei Shien 236
TAIWAN

Mr. Grant Huang

Phone: 886-2-22608375 Fax: 886-2-22748013

E-Mail: hometek@ms15.hinet.net

**ELECTROMAGNETIC COMPATIBILITY
AND TELECOMMUNICATIONS**

NVLAP LAB CODE 200331-0

NVLAP Code Designation / Description

Emissions Test Methods:

| | |
|------------|--|
| 12/CIS14a | EN 55014-1 (1993), A1 (1997), A2 (1999): |
| 12/CIS14a2 | BS EN 55014-1 (2001) with A1 and A2: Electromagnetic compatibility - Requirements for household appliances, electric tools and similar apparatus - Part 1: Emission |
| 12/CIS14b1 | AS/NZS CISPR 14-1 (2003): Electromagnetic Compatibility - Requirements for household appliances, electric tools and similar apparatus - Part 1: Emission |
| 12/CIS14c | CNS 13783-1: Electromagnetic Compatibility Requirements for household appliances, electric tools and similar apparatus - Part 1: Emissions |
| 12/CIS14d | IEC/CISPR 14-1 (2001) and A1 (2001): Electromagnetic Compatibility - Requirements for household appliances, electric tools and similar apparatus - Part 1: Emissions |
| 12/CIS14x | IEC/CISPR 14-1, Ed. 4 (2003): Electromagnetic Compatibility - Requirements for household appliances, electric tools and similar apparatus - Part 1: Emission |
| 12/CIS22 | IEC/CISPR 22 (1997) & EN 55022 (1998) + A1(2000): Limits and methods of measurement of radio disturbance characteristics of information technology equipment |

2007-10-01 through 2008-09-30

Effective dates

For the National Institute of Standards and Technology



National Voluntary Laboratory Accreditation Program



ELECTROMAGNETIC COMPATIBILITY AND TELECOMMUNICATIONS

NVLAP LAB CODE 200331-0

| <i>NVLAP Code</i> | <i>Designation / Description</i> |
|-------------------|--|
| 12/CIS22a | IEC/CISPR 22 (1993) and EN 55022 (1994): Limits and methods of measurement of radio disturbance characteristics of information technology equipment, Amendment 1 (1995) and Amendment 2 (1996) |
| 12/CIS22b | CNS 13438 (1997): Limits and Methods of Measurement of Radio Interference Characteristics of Information Technology Equipment |
| 12/CIS22c | IEC/CISPR 22, Fourth Edition (2003-04) & EN 55022 (1998): Information technology equipment - Radio disturbance characteristics - Limits and methods of measurement |
| 12/FCC15b | ANSI C63.4 (2003) with FCC Method 47 CFR Part 15, Subpart B: Unintentional Radiators |
| 12/T51a | AS/NZS CISPR 22 (2004): Information technology equipment - Radio disturbance characteristics - Limits and methods of measurement |
| 12/VCCIa | VCCI: Agreement of Voluntary Control Council for Interference by Information Technology Equipment - Technical Requirements: V-3/2005.04 |

2007-10-01 through 2008-09-30

Effective dates

For the National Institute of Standards and Technology