



ADDRESS: No. 67-9, Shir Men Road, Tu Cheng City,
Taipei Hsien, Taiwan

PHONE : 886-2-22608375 FAX : 886-2-22748013

E - mail : hometek@ms15.hinet.net

CE TEST REPORT FOR

APPLICANT : Smart Home Engineering Corp.
ADDRESS : 10F., No. 493, Chung-Cheng Rd.,
Hsin-Tien City, Taipei 231, Taiwan, R. O. C.
Receipt Date : 06/15/2006 Final Test Date: 06/26/2006
EUT : CAT5 AV Multimedia Transmission
MODEL NO. : SE0XXX

MEASUREMENT PROCEDURE USED

EN55022 CLASS B / EN61000-3-2 / EN61000-3-3 / EN55024 GIVEN IN
EUROPEAN COUNCIL DIRECTIVE 2004/108/EC

This test result of this report applies to above tested sample only.

This test report shall not be reproducing in part without written approval of HomeTek Technology Inc.

PREPARED BY :

HomeTek Technology Inc.

No. 67-9, Shir Men Road, Tu Cheng City,

Taipei Hsien. Taiwan

Report # : EB6K026

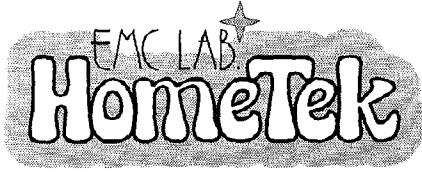

HomeTek Technology Inc.

ADDRESS: No. 67-9, Shir Men Road, Tu Cheng City,
Taipei Hsien

PHONE : 886-2-22608375 FAX : 886-2-22748013

E - mail : hometek@ms15.hinet.net

CERTIFICATE OF COMPLIANCE

EUT : CAT5 AV Multimedia Transmission
 MODEL NO. : SE0XXX
 Receipt Date : 06/15/2006 Final Test Date: 06/26/2006
 REPORT # : EB6K026
 APPLICANT : Smart Home Engineering Corp.
 ADDRESS : 10F., No. 493, Chung-Cheng Rd.,
Hsin-Tien City, Taipei 231, Taiwan, R. O. C.

Measurement procedure used:

EMI: EN 55022 Class B (1998) + A1 (2000) + A2 (2003),

EN 61000-3-2 (2000), EN 61000-3-3 (1995) + A1 (2001)

EMS: EN 55024 (1998) + A1 (2001) + A2 (2003):

IEC 61000-4-2 (2001), IEC 61000-4-3 (2002), IEC 61000-4-4 (2004), IEC 61000-4-5 (2001),

IEC 61000-4-6 (2003) + A1 (2004), IEC 61000-4-8 (2001), IEC 61000-4-11 (2004)

We hereby show that:

The measurements shown in this test report were made in accordance with the procedures given in **EUROPEAN COUNCIL DIRECTIVE 2004/108/EC**, and the energy emitted by the equipment was found to be within the limits applicable. This product, which has been issued the test report listed as above in HomeTek Technology Inc., is based on single evaluation of one sample and confirmed to comply with the requirements of the above-mentioned EMC standard.

This test report is a duplicate of original one (report No. EB5F009, issued on 2006, 06, 29),
applicant and model No. is modified.

APPROVED BY :  11/23/2007

ALAIN LIN / Assistant Manage

EB6K026



HomeTek Technology Inc.

DESCRIPTION OF UPGRADE OF TEST STANDARDS

Applicant: Smart Home Engineering Corp.

Product Name: CAT5 AV Multimedia Transmission

Model Number: SE0XXX

The test standard of this report (No. EB6K026) is updated from original one (No. EB5F009) with the procedures given in **EUROPEAN COUNCIL DIRECTIVE 2004/108/EC: EN 55022 Class B (1998) + A1 (2000) + A2 (2003) / EN 61000-3-2 (2000) / EN 61000-3-3 (1995) + A1 (2001) / EN 55024 (1998) + A1 (2001) + A2 (2003): IEC 61000-4-2 (2001), IEC 61000-4-3 (2002), IEC 61000-4-4 (2004), IEC 61000-4-5 (2001), IEC 61000-4-6 (2003) + A1 (2004), IEC 61000-4-8 (2001), IEC 61000-4-11 (2004)**. According to EUT's specification and operation manual, the test procedures of new version of standards are applied to EUT. Thus, we HomeTek issue a new certificate with new version of test standard.

HomeTek Inc.

November, 23, 2007

ALAIN LIN / Assistant Manager

TEST REPORT CERTIFICATION**EMC of electrical appliances**

Report reference No. : EB6K026
Date of issue : NOV., 23, 2007
Applicant : Smart Home Engineering Corp.
Address : 10F., No. 493, Chung-Cheng Rd.,
Hsin-Tien City, Taipei 231, Taiwan, R. O. C.
Manufacturer : Smart Home Engineering Corp.
Type of test object : CAT5 AV Multimedia Transmission
Model/type reference : SE0XXX
Rated Voltage : N/A
EUT Voltage : N/A
Test Result : Complied
Testing laboratory : HomeTek Technology Inc.
Address : No. 67-9, Shir Men Road, Tu Cheng City, Taipei Hsien,
Taiwan, R. O. C.
TEL / FAX : +886-2-22608375 / +886-2-22748013
E-mail : hometek@ms15.hinet.net
Standard : EN 55022 Class B (1998) + A1 (2000) + A2 (2003),
EN 61000-3-2 (2000), EN 61000-3-3 (1995) + A1 (2001),
EN 55024 (1998) + A1 (2001) + A2 (2003):
IEC 61000-4-2 (2001), IEC 61000-4-3 (2002),
IEC 61000-4-4 (2004), IEC 61000-4-5 (2001),
IEC 61000-4-6 (2003) + A1 (2004), IEC 61000-4-8 (2001),
IEC 61000-4-11 (2004)

Tested by (+ signature) :
Jason Lin / Engineer

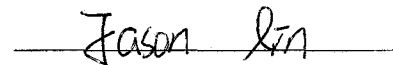

Approved by (+ signature) :
Alain Lin / Assistant Manager

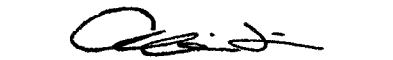



DESCRIPTION OF UPGRADE OF TEST STANDARDS 1

TEST REPORT CERTIFICATION..... 2

TABLE OF CONTENTS..... 3

GENERAL INFORMATION..... 5

MODIFICATION LIST 6

CONDUCTED POWER LINE TEST 7

 1 TEST PROCEDURE..... 7

 2 RESULT OF CONDUCTED EMISSION TEST..... 7

RADIATED EMISSION TEST..... 8

 1 TEST INSTRUMENTS & FACILITIES..... 8

 2 TEST PROCEDURE..... 9

 3 TEST SETUP 9

 4 CONFIGURATION OF THE EUT 11

 5 EUT OPERATING CONDITION..... 14

 6 LIMIT OF RADIATED EMISSION CLASS B 14

 7 RESULT OF RADIATED EMISSION TEST..... 14

 8 RADIATED EMISSION TEST DATA (PAGE 1)..... 15

 9 RADIATED EMISSION TEST DATA (PAGE 2)..... 16

HARMONICS TEST..... 17

 1 TEST PROCEDURE..... 17

 2 RESULT OF HARMONICS TEST 17

VOLTAGE FLUCTUATIONS TEST 18

 1 TEST PROCEDURE..... 18

 2 RESULT OF VOLTAGE FLUCTUATIONS TEST 18

ELECTROSTATIC DISCHARGE IMMUNITY TEST (ESD) 19

 1 TEST INSTRUMENTS & FACILITIES..... 19

 2 TEST PROCEDURE..... 19

 3 TEST SETUP 19

 4 CONFIGURATION OF THE EUT 20

 5 EUT OPERATION CONDITION..... 20

 6 TEST CONDITION 20

 7 PERFORMANCE CRITERIA 20

 8 TEST RESULT 21

RADIO FREQUENCY ELECTROMAGNETIC FIELD IMMUNITY TEST (RF)..... 22

 1 TEST INSTRUMENTS & FACILITIES..... 22

 2 TEST PROCEDURE..... 22

 3 TEST SETUP 23

 4 CONFIGURATION OF THE EUT 24



5 OPERATION CONDITION OF EUT 24

6 TEST CONDITION 24

7 PERFORMANCE CRITERIA 24

8 TEST RESULT 25

ELECTRICAL FAST TRANSIENT/BURST IMMUNITY TEST (EFT)..... 26

1 TEST INSTRUMENTS & FACILITIES..... 26

2 TEST PROCEDURE..... 26

3 TEST SETUP 26

4 CONFIGURATION OF THE EUT 27

5 OPERATION CONDITION OF EUT 27

6 TEST CONDITION 27

7 PERFORMANCE CRITERIA 27

8 TEST RESULT 28

SURGE IMMUNITY TEST 29

1 TEST PROCEDURE..... 29

2 RESULT OF SURGE IMMUNITY TEST 29

IMMUNITY TEST TO CS CONDUCTED DISTURBANCE 30

1 TEST PROCEDURE..... 30

2 RESULT OF IMMUNITY TEST TO CS CONDUCTED DISTURBANCE 30

POWER FREQUENCY MAGNETIC FIELD IMMUNITY TEST 31

1 TEST INSTRUMENTS & FACILITIES..... 31

2 TEST STANDARD..... 31

3 TEST SETUP 31

4 TEST LEVELS..... 32

5 CONFIGURATION OF THE EUT 32

6 OPERATION CONDITION OF EUT..... 32

7 CONDITIONS DURING TESTING..... 32

8 PERFORMANCE CRITERIA 32

9 TEST RESULTS 33

VOLTAGE DIPS, SHORT INTERRUPTIONS IMMUNITY TEST 34

1 TEST PROCEDURE..... 34

2 RESULT OF VOLTAGE DIPS, SHORT INTERRUPTIONS IMMUNITY TEST 34

APPENDIX A

PHOTOS OF TEST CONFIGURATION

APPENDIX B

PHOTOS OF EUT

GENERAL INFORMATION

- 1 APPLICANT : Smart Home Engineering Corp.
- 2 ADDRESS : 10F., No. 493, Chung-Cheng Rd.,
Hsin-Tien City, Taipei 231, Taiwan, R. O. C.
- 3 MANUFACTURER : Smart Home Engineering Corp.
- 4 ADDRESS : 10F., No. 493, Chung-Cheng Rd.,
Hsin-Tien City, Taipei 231, Taiwan, R. O. C.
- 5 DESCRIPTION OF EUT :
- EUT : CAT5 AV Multimedia Transmission
- Model : SE0XXX
- Serial # : N/A

5.1 The difference between series of models SE0XXX are as shown below:

- (1) The first and second “X” represent different system input.
- (2) The third “X” represent different accessory.

The PCB layout is similar. The worst case of EMC test data were shown in this test report.

- 6 FEATURES OF EUT :

Please refer to user manual or product specification.



HomeTek Technology Inc.

MODIFICATION LIST

THE FOLLOWING ACCESSORIES WERE ADDED TO THE EUT DURING TESTING :

NO MODIFICATION BY HOMETEK TECHNOLOGY INC.

CONDUCTED POWER LINE TEST

1 TEST PROCEDURE

According to **EN55022 Class B**.

2 RESULT OF CONDUCTED EMISSION TEST

N/A (Conducted Power Line Test is not applicable to this EUT (Model : SE01)).

RADIATED EMISSION TEST

1 TEST INSTRUMENTS & FACILITIES

The following test Instruments was used during the radiated emission test :

Item	Instruments /facilities	Specification	Manufacturer	Model # / S/N#	Date of Cal.
1	OPEN AREA TEST SITE	<input checked="" type="checkbox"/> OATS 3			JUL/2005
2	EMI TEST RECEIVER	20Hz ~ 26.5GHz	ROHDE & SCHWARZ	ESMI 845442/006	FEB/2006
3	PRE-AMPLIFIER	9KHz ~ 3000MHz	ADVANTEST	BB525C 90081001	OCT/2005
4	ANTENNA (BI-LOG)	25MHz ~ 2GHz	SCHAFFNER	CBL6112B S/N : 2614	JUN/2006
5	Attenuation	50Ω/6dB	JYE BAO	FAT-N (M-F) 001	JUL/2005
6	Ferrite Clamp	30 ~ 1000MHz	ADT	FC18 910030	DEC/2005
7	Ferrite Clamp	30 ~ 1000MHz	HomeTek	HFC 001	DEC/2005
8	Cable	10m	SUHNER	RG214/U OS3-003	DEC/2005
9	Cable	14m	BELDEN	9913 OS3-001	DEC/2005
10	EMI 32 (software)	N/A	AUDIX	19991013-0923	N/A

Note : Items 1 ~ 9 were calibrated within period of 1 year.

2 TEST PROCEDURE

- 2.1 The EUT was test according to **EN55022**.
- 2.2 The radiated test was performed at HomeTek Lab's Open Site 3.
- 2.3 The frequency range from 30 MHz to 1 GHz, the measurement were made at 10 meters, with a BI-log antenna.

3 TEST SETUP

3.1 TEST SETUP OF OPEN SITE.

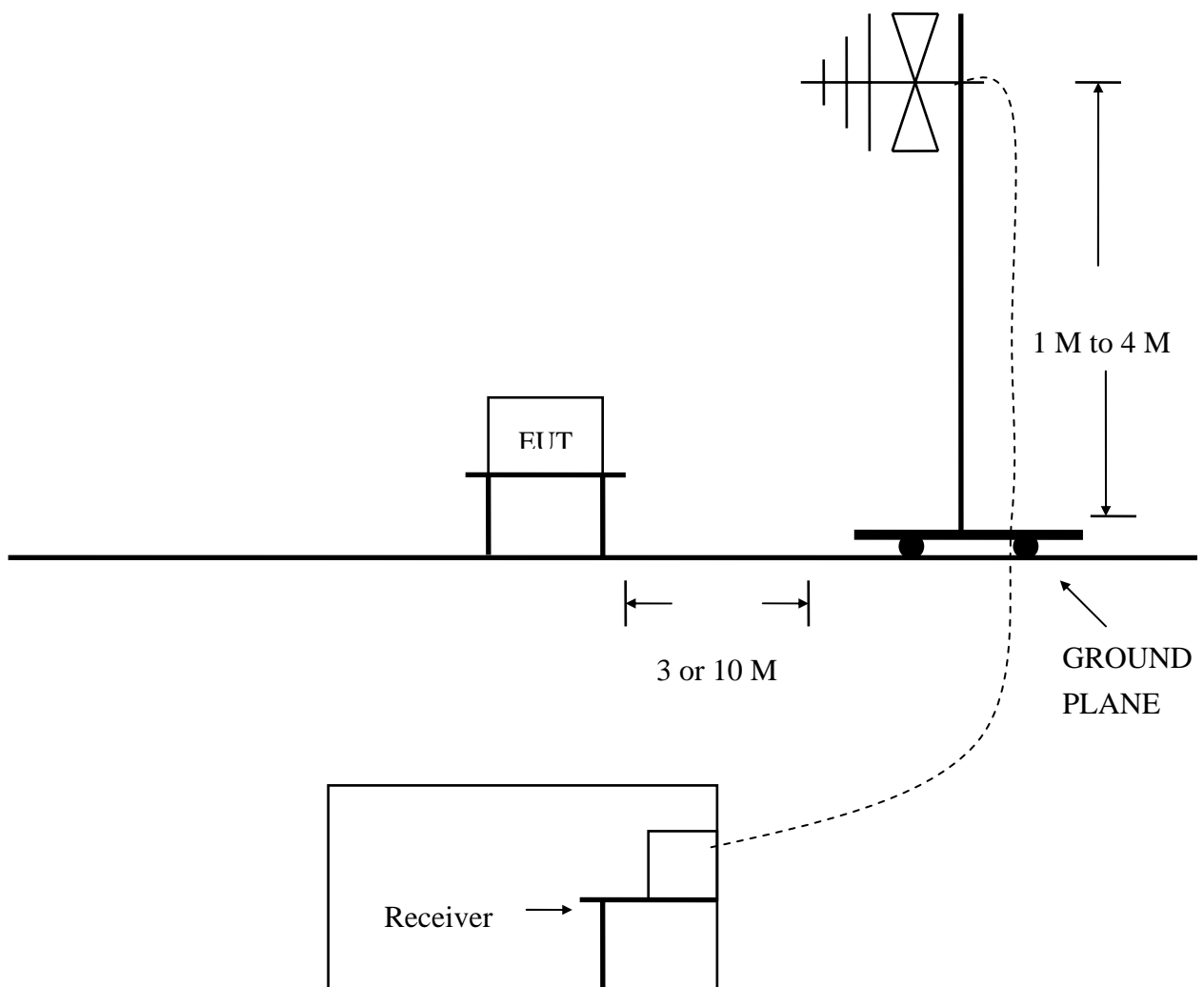

(Details for setup configuration, please refer to appendix A.)

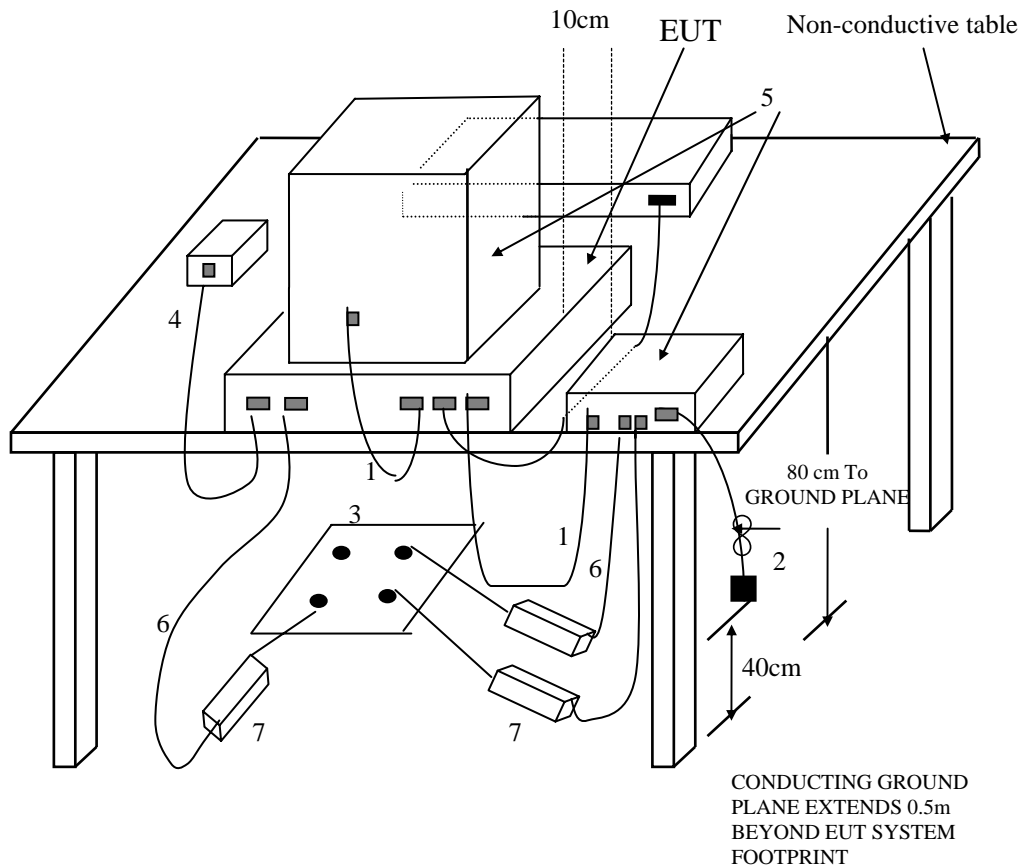

(Details for setup configuration, please refer to appendix A.)

LEGEND:

- 1.If cables, which hang closer than 40 cm to the horizontal metal ground plane cannot be shortened to the appropriate length, the excess shall be folded back and forth forming a bundle 30 cm to 40 cm long.
- 2.The end of I/O signal cables which are not connected to a peripheral may be terminated, if required for proper operation using correct terminating impedance.
- 3.Mains junction box(es) shall be flush with, and bonded directly to, the metal ground plane.
NOTE if used, the AMN shall be installed under the horizontal metal ground plane.
- 4.Cables of hand-operated devices such as keyboards, mice, etc. shall be placed as for normal usage.
- 5.Peripherals shall be placed at a distance of 10 cm from each other and from the controller, except for the monitor which, if for an acceptable installation practice, shall be placed directly on top of the controller.
- 6.Mains cables, telephone lines or other connections to auxiliary equipment located outside the test area shall drape to the floor, be fitted with ferrite clamps or ferrite tubes placed on the floor at the point where the cable reaches the floor and then routed to the place where they leave the turntable. No extension cords shall be used to mains receptacle.
- 7.Ferrite clamps or ferrite tubes with similar characteristics (as defined in 10.4). No more than one cable per clamp.

Test Configuration
Tabletop Equipment Radiated Measurement

4 CONFIGURATION OF THE EUT

The EUT was configured according to **EN55022**. All I/O ports were connected to the appropriate peripherals. All peripherals and cables are listed below (including internal device) :

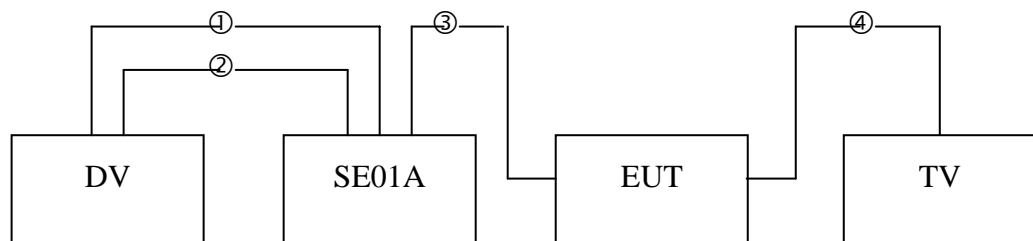

- ① S-Video Cable
- ② Audio Cable x 2
- ③ RJ-45 Cable
- ④ S-Video Cable

Figure 1



4.1 EUT

EUT Type : Proto Type Engineer Type Mass Production
Condition when received : Good Damage : _____
Device : CAT5 AV Multimedia Transmission
Applicant : Smart Home Engineering Corp.
Manufacturer : Smart Home Engineering Corp.
Model Number : SE0XXX
Serial Number : N/A
FCC ID : N/A
RJ-45 Port : Plastic Type
S-Video Port : Metal Type
Power Cord : N/A
Power Supply Type : N/A

4.2 PERIPHERALS

DV

Manufacturer : SONY
Model Number : DCR-PC110
Serial Number : 1158142
FCC ID : FCC DoC
Data Cable 1 : Shielded, 1.5 m, Connect to the S-Video port
Data Cable 2 x 2 : Shielded, 1.8 m, Connect to the Audio port
Power Cord : Un-Shielded, 1.8 m



TV

Manufacturer : TCL
Model Number : 1419A
Serial Number : N/A
FCC ID : N/A
Data Cable : Shielded, 0.3 m, Connect to the S-Video port
Power Cord : Un-Shielded, 1.8 m

CAT5 AV Multimedia Transmission

Manufacturer : Smart Home Engineering Corp.
Model Number : SE01A
Serial Number : N/A
FCC ID : N/A
Data Cable : Un-Shielded, 1.5 m, Connect to the RJ-45 port
Power Cord : N/A

4.3 REMARK : N/A

5 EUT OPERATING CONDITION

- 5.1 The frequency of the EUT is none.
- 5.2 The radiated emission in the frequency range from 30 MHz - 1000 MHz was test in a horizontal and vertical polarization at HomeTek Lab’s open site 3.
- 5.3 Turn on all the power of EUT and peripheral.
- 5.4 DV send 1KHz audio and color bar signal through SE01A via RJ-45 cable to EUT.
- 5.5 EUT transform signal to TV via S-Video cable.
- 5.6 TV the output signal of EUT during the test.
- 5.7 **The photos of radiated test configuration, please refer to appendix A.**

6 LIMIT OF RADIATED EMISSION CLASS B

Frequency (MHz)	Measurement Distance	Limit (dBuV/m)
30 - 230	10 (M)	30
230 - 1000	10 (M)	37

7 RESULT OF RADIATED EMISSION TEST

- 7.1 The frequency range from 30 MHz to 1 GHz was investigated.
- 7.2 All readings below or equal 1 GHz are quasi-peak or peak values with resolution bandwidth of 120 KHz.
- 7.3 The measurements were made at 10 meters of HomeTek Lab’s open site 3.
- 7.4 Temperature : 31 °C, Humidity : 51 % RH.
- 7.5 Deviation form the test standards and rules : None.
- 7.6 The radiated emission result were gained by the following method :
 Level = Reading Level + Probe Factor (Antenna Factor) + Cable Loss – Preamp Factor
 Over Limit = Level – Limit Line
- 7.7 Result : **PASSED**

8 RADIATED EMISSION TEST DATA (PAGE 1)



HomeTek Technology Inc.

No 67-9, Shi-Men Rd., Tu-Chen City,
 Taipei County, Taiwan R.O.C.
 Tel: 02-22608375
 Fax: 02-22748013

Data#: 2 File#: 6K026.EMI

Date: 2006-06-26 Time: 16:40:49

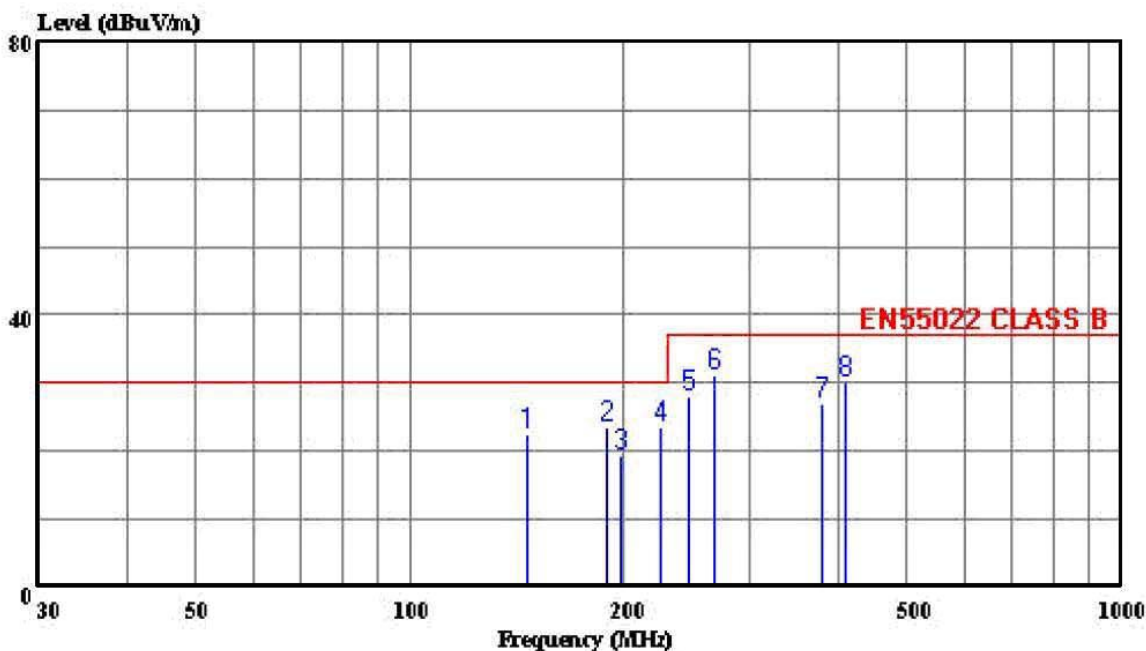

Trace:

Ref Trace:

Condition: EN55022 CLASS B 10m CHASE 2614 060506 HORIZONTAL
 eut : CAT5 AV Multimedia Transmission
 power: N/A
 memo : SE01

Page: 1

	Freq	Level	Limit	Over	ReadAntenna	Cable	Preamp	Remark
	MHz	dBuV/m	dBuV/m	dB	dBuV	dB/m	dB	
1	146.027	22.37	30.00	-7.63	35.80	10.62	1.65	25.70 Peak
2	189.367	23.52	30.00	-6.48	38.34	8.90	1.92	25.64 Peak
3	197.673	19.51	30.00	-10.49	34.08	9.09	1.98	25.63 Peak
4	224.687	23.59	30.00	-6.41	37.41	9.70	2.08	25.60 Peak
5	246.000	28.19	37.00	-8.81	39.62	11.98	2.16	25.57 Peak
6	268.673	31.10	37.00	-5.90	41.68	12.73	2.24	25.55 Peak
7	378.927	27.08	37.00	-9.92	34.58	15.09	2.78	25.37 Peak
8	408.000	30.04	37.00	-6.96	36.65	15.76	2.93	25.30 Peak

9 RADIATED EMISSION TEST DATA (PAGE 2)



HomeTek Technology Inc.

No 67-9, Shi-Men Rd., Tu-Chen City,
 Taipei County, Taiwan R.O.C.
 Tel: 02-22608375
 Fax: 02-22748013

Data#: 1 File#: 6K026.EMI

Date: 2006-06-26 Time: 16:08:30

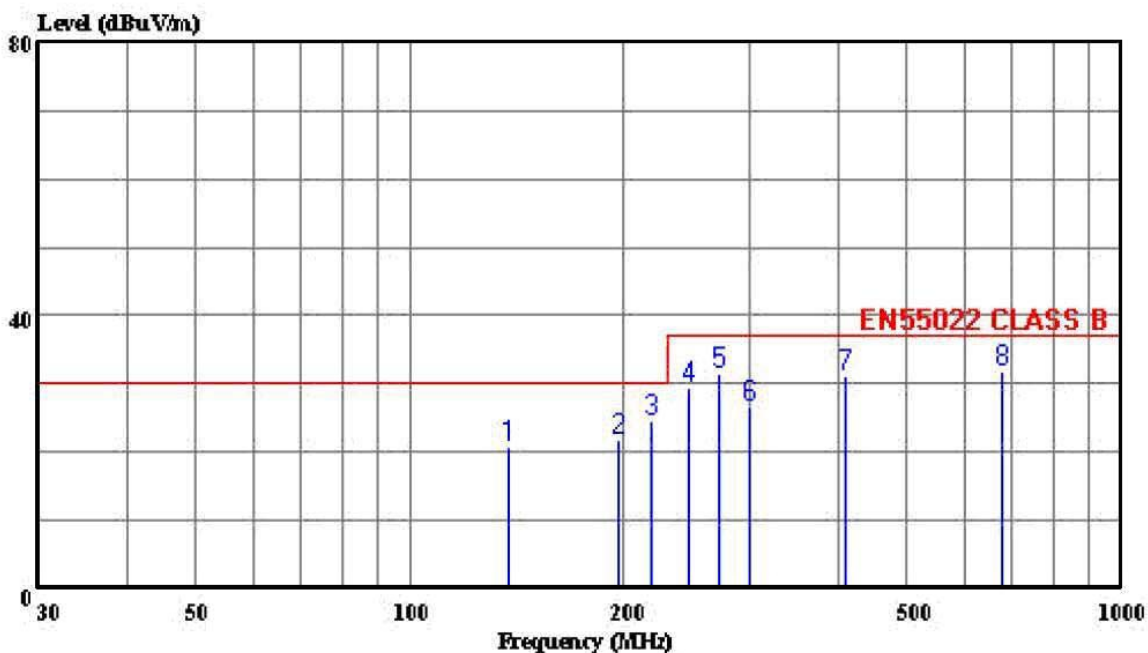

Trace:

Ref Trace:

Condition: EN55022 CLASS B 10m CHASE 2614 060506 VERTICAL
 eut : CAT5 AV Multimedia Transmission
 power: N/A
 memo : SE01

Page: 1

	Limit	Over	ReadAntenna	Cable	Preamp			
Freq	Level	Line	Limit	Level	Factor	Loss	Factor	Remark
MHz	dBuV/m	dBuV/m	dB	dBuV	dB/m	dB	dB	
1	137.000	20.89	30.00	-9.11	33.58	11.43	1.60	25.72 Peak
2	195.640	21.93	30.00	-8.07	36.56	9.04	1.96	25.63 Peak
3	219.000	24.68	30.00	-5.32	39.06	9.17	2.06	25.60 Peak
4	246.000	29.29	37.00	-7.71	40.72	11.98	2.16	25.57 Peak
5	272.540	31.46	37.00	-5.54	42.09	12.66	2.26	25.55 Peak
6	300.000	26.64	37.00	-10.36	36.67	13.13	2.37	25.52 Peak
7	408.000	31.24	37.00	-5.76	37.85	15.76	2.93	25.30 Peak
8	679.000	31.93	37.00	-5.07	33.04	18.88	4.09	24.08 Peak

HARMONICS TEST

1 TEST PROCEDURE

According to **EN 61000-3-2 (2000)**.

2 RESULT OF HARMONICS TEST

N/A (This standard is not applicable to this EUT (Model : SE01)).

VOLTAGE FLUCTUATIONS TEST

1 TEST PROCEDURE

According to **EN 61000-3-3 (1995) + A1 (2001)**.

2 RESULT OF VOLTAGE FLUCTUATIONS TEST

N/A (This standard is not applicable to this EUT (Model : SE01)).

4 CONFIGURATION OF THE EUT

Same as “Radiated Emission test”, section 4

5 EUT OPERATION CONDITION

Same as “Radiated Emission test”, section 5

6 TEST CONDITION

6.1 Test Level :

(A) ± 2 , ± 4 , ± 8 KV for air discharge.

(B) ± 2 , ± 4 KV for contact discharge.

6.2 Number of test : 10 Discharges / Test point / Polarity / Level

Particular requirements : at least 200 discharges, 100 each at negative and positive polarity, at a minimum of four test points.

6.3 Time between test : 1 sec.

6.4 Temperature : 23 °C

6.5 Humidity : 50 % RH.

7 PERFORMANCE CRITERIA

- A. The apparatus shall continue to operate as intended during and after the test. No degradation of performance or loss of function is allowed below a performance level specified by the manufacturer, when the apparatus is used as intended.
- B. The apparatus shall continue to operate as intended after the test. No degradation of performance or loss of function is allowed below a performance level specified by the manufacturer, when the apparatus is used as intended. The performance level may be replaced by a permissible loss of performance. During the test, degradation of performance is however allowed.
- C. Temporary loss of function is allowed, provided the function is self-recoverable or can be restored by the operation of the controls.

8 TEST RESULT

Test Point	Air Discharge	Contact Discharge	Performance Criteria	Result
HCP	---	$\pm 2, \pm 4KV$	A	PASSED
VCP	---	$\pm 2, \pm 4KV$	A	PASSED
CASE	$\pm 2, \pm 4, \pm 8KV$	$\pm 2, \pm 4KV$	A	PASSED
I/O PORTS	$\pm 2, \pm 4, \pm 8KV$	$\pm 2, \pm 4KV$	A	PASSED

9 Photos of test configuration please refer to appendix A.

RADIO FREQUENCY ELECTROMAGNETIC FIELD IMMUNITY TEST (RS)

1 TEST INSTRUMENTS & FACILITIES

Item	Instruments Facilities	Manufacturer	Model # Serial #	Data Of Cal.
1	SIGNAL GENERATOR	ROHDE & SCHWARZ	SMY02 845181/025	MAR/2006
2	AMPLIFIER	AMPLIFIER RESEARCH	100W1000M1A	N/A
3	FIELD SENSOR	AMPLIFIER RESEARCH	FP2000	AUG/2004
4	FIELD MONITOR	AMPLIFIER RESEARCH	FM2000	AUG/2004
5	RF VOLTMETER	BOONTON	9200C 361701AA	MAR/2006
6	RF PROBE	BOONTON	952001B 37082	MAR/2006
7	DIRECTION COUPLER	AMPLIFIER RESEARCH	DC6180 20521	N/A
8	ANTENNA	EMCO	3142B S/N: 1789	N/A
9	CONTROL PC	KB TECH	KB P586/133	--

Note : Items 3 ~ 4 were calibrated with two years and verified before testing.

2 TEST PROCEDURE

According to **IEC 61000-4-3 (2002)**

According to **EN 55024 (1998) + A1 (2001) + A2 (2003)**

3 TEST SETUP

FERRITE TILE

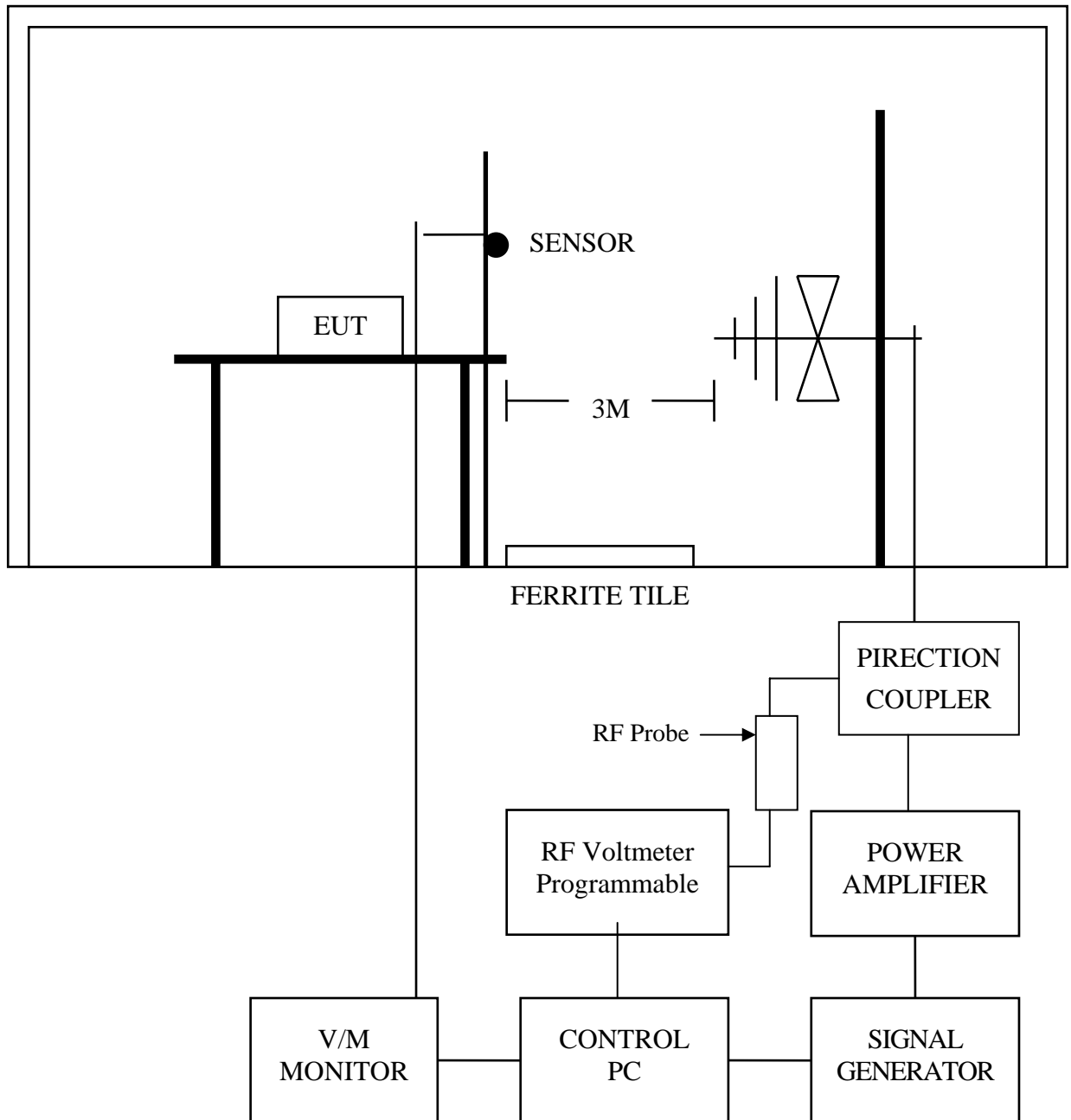

3.1 Chamber Size :

12M x 5M x 5M

(Details for setup configuration, please refer to appendix A.)

4 CONFIGURATION OF THE EUT

Same as “Radiated Emission test”, section 4

5 OPERATION CONDITION OF EUT

Same as “Radiated Emission test”, section 5

6 TEST CONDITION

6.1 Frequency Range : 80 MHz ~ 1000 MHz

(Frequency Range : 1.4 GHz ~ 2.0 GHz is not applicable for EN55024:1998+A1:2001+A2:2003)

6.2 Filed Strength : 3 V / M (1KHz 80% Modulation)

6.3 Frequency Step : 1 %, 3 sec. / each step size

6.4 Antenna Polarity : HORIZONTAL & VERTICAL

6.5 The four sides of EUT are tested
(FRONT, REAR, RIGHT, LEFT)

6.6 Temperature : 26 °C

6.7 Humidity : 54 % RH

7 PERFORMANCE CRITERIA

- A. The apparatus shall continue to operate as intended during and after the test. No degradation of performance or loss of function is allowed below a performance level specified by the manufacturer, when the apparatus is used as intended.
- B. The apparatus shall continue to operate as intended after the test. No degradation of performance or loss of function is allowed below a performance level specified by the manufacturer, when the apparatus is used as intended. The performance level may be replaced by a permissible loss of performance. During the test, degradation of performance is however allowed.
- C. Temporary loss of function is allowed, provided the function is self-recoverable or can be restored by the operation of the controls.

8 TEST RESULT

ANT SIDE	HORIZONTAL	VERTICAL	RESULT
FRONT	A	A	PASSED
REAR	A	A	PASSED
RIGHT	A	A	PASSED
LEFT	A	A	PASSED

9 Photos of test configuration please refer to appendix A.

ELECTRICAL FAST TRANSIENT/BURST IMMUNITY TEST (EFT)

1 TEST INSTRUMENTS & FACILITIES

Instruments/ Facilities	Manufacturer	Model # Serial #	Data Of Cal.
BURST-TESTER	HAEFELY	PEFT/JUNIOR	FEB/2006
CONTROL PC	KB TECH	KB P586/133	--

2 TEST PROCEDURE

According to **IEC 61000-4-4 (2004)**

According to **EN 55024 (1998) + A1 (2001) + A2 (2003)**

3 TEST SETUP

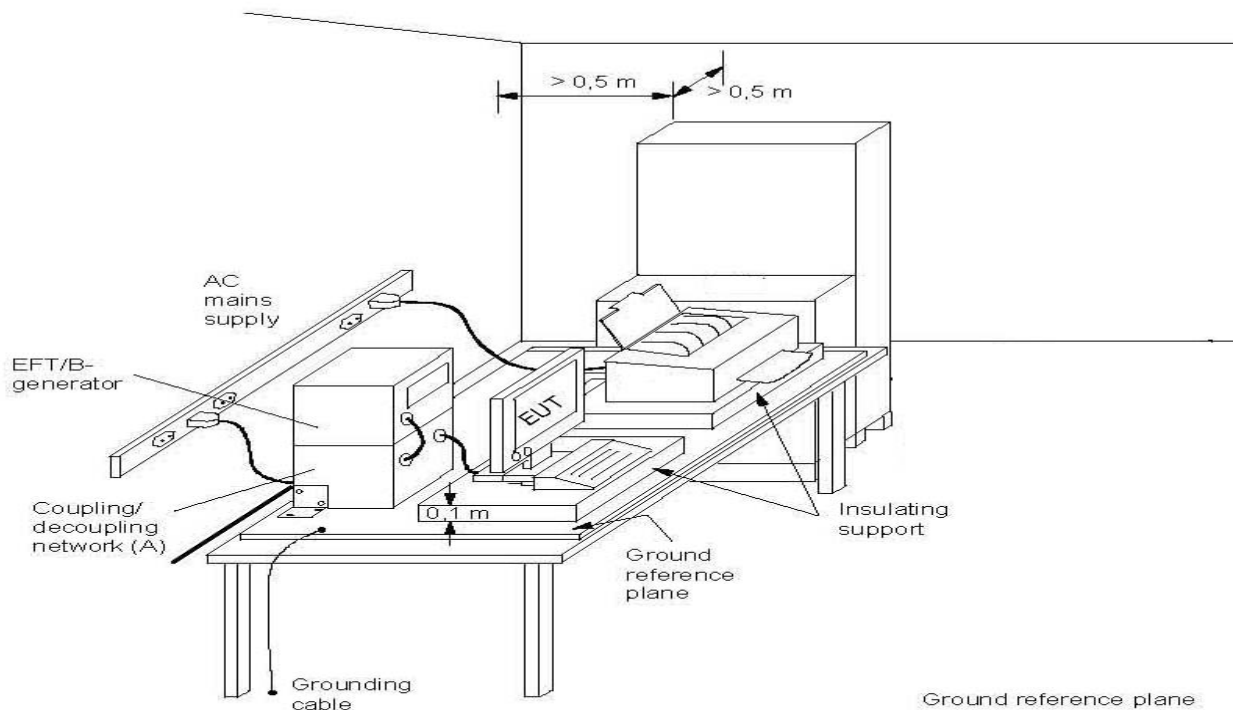

(Details for setup configuration, please refer to appendix A.)

Note: length between clamp and the EUT to be tested (should be $0.5 \text{ m} \pm 0.05 \text{ m}$)

(A) location for supply line coupling

(B) location for signal line coupling

4 CONFIGURATION OF THE EUT

Same as “Radiated Emission test”, section 4

5 OPERATION CONDITION OF EUT

Same as “Radiated Emission test”, section 5

6 TEST CONDITION

6.1 Pulse Rise time & Duration : 5 nS / 50 nS

6.2 Pulse Repetition : 5 kHz

6.3 Polarity : POSITIVE / NEGATIVE

6.4 Coupling of power line :

L, N, PE, L+N, L+PE, N+PE, L+N+PE

6.5 Test Voltage of Signal Control Line : $\pm 0.25\text{KV}$, $\pm 0.5\text{KV}$

6.6 Temperature : 24 °C

6.7 Humidity : 55 % RH

7 PERFORMANCE CRITERIA

A. The apparatus shall continue to operate as intended during and after the test. No degradation of performance or loss of function is allowed below a performance level specified by the manufacturer, when the apparatus is used as intended.

B. The apparatus shall continue to operate as intended after the test. No degradation of performance or loss of function is allowed below a performance level specified by the manufacturer, when the apparatus is used as intended. The performance level may be replaced by a permissible loss of performance. During the test, degradation of performance is however allowed.

C. Temporary loss of function is allowed, provided the function is self-recoverable or can be restored by the operation of the controls.

8 TEST RESULT

Signal Control Line :

TEST VOLTAGE	PERFORMACE CRITERIA
$\pm 0.25\text{KV}$	A
$\pm 0.5\text{KV}$	A

8.1 Model : SE01

8.2 Final Result : PASSED

8.3 Remark :

9 Photos of test configuration please refer to appendix A.

SURGE IMMUNITY TEST

1 TEST PROCEDURE

According To **IEC 61000-4-5 (2001)**

According To **EN 55024 (1998) + A1 (2001) + A2 (2003)**

2 RESULT OF SURGE IMMUNITY TEST

N/A (This standard is not applicable to this EUT (Model : SE01)).

IMMUNITY TEST TO CS CONDUCTED DISTURBANCE

1 TEST PROCEDURE

According To **IEC 61000-4-6 (2004)**

According To **EN 55024 (1998) + A1 (2001) + A2 (2003)**

2 RESULT OF IMMUNITY TEST TO CS CONDUCTED DISTURBANCE

N/A (This standard is not applicable to this EUT (Model : SE01)).

POWER FREQUENCY MAGNETIC FIELD IMMUNITY TEST

1 TEST INSTRUMENTS & FACILITIES

Instruments/ Facilities	Manufacturer	Model # Serial #	Data Of Cal.
LINE INTERFERENCE TESTER	HAEFELY	PLINE 1610 080166-10	MAR/2006
MAGNETIC FIELD TESTER	HAEFELY	MAG 100.1 080206-01	N/A
TRIAXIAL ELF MAGNETIC FIELD METER	F.W.BELL	4080 9645	JUL/2005
CONTROL PC	KB TECH	KB P586/133	--

2 TEST STANDARD

According To **IEC 61000-4-8 (2001)**

According To **EN 55024 (1998) + A1 (2001) + A2 (2003)**

3 TEST SETUP

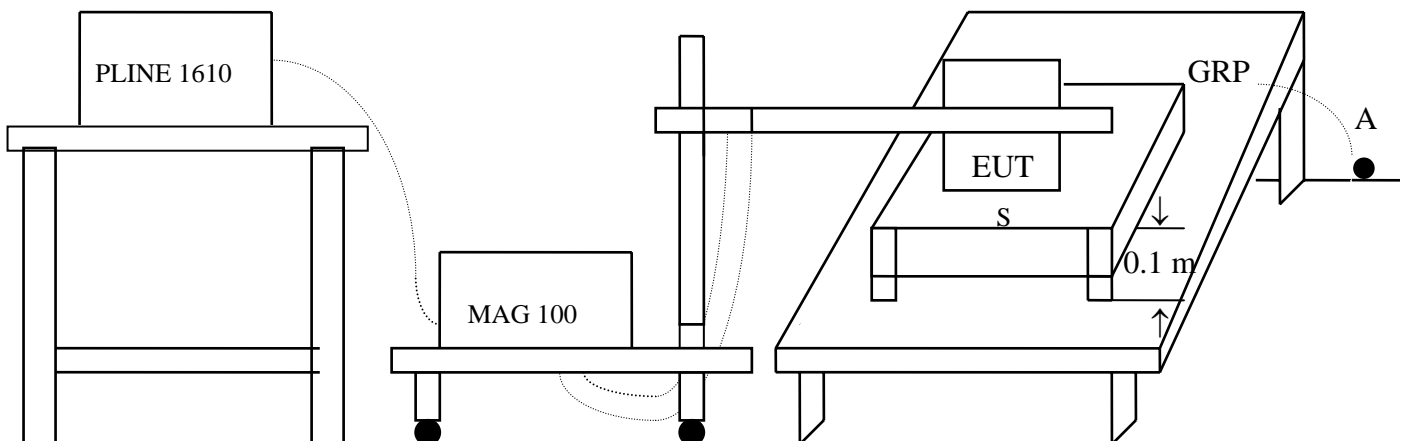

S: Insulating support

A: Safety earth

GRP: Ground plane

(Details for setup configuration, please refer to appendix A.)

4 TEST LEVELS

Environmental Phenomena	Test Specification	Units	Performance Criteria
Power Frequency	50	HZ	
Magnetic Field	1	A/m	B

5 CONFIGURATION OF THE EUT

Same as “Radiated Emission test”, section 4

6 OPERATION CONDITION OF EUT

Same as “Radiated Emission test”, section 5

7 CONDITIONS DURING TESTING

7.1 Temperature : 24 °C (15°C ~ 35°C)

Humidity : 55 % RH.(25 % ~ 75%)

7.2 The induction coil shall be rotated by 90°

8 PERFORMANCE CRITERIA

- A. The apparatus shall continue to operate as intended during and after the test. No degradation of performance or loss of function is allowed below a performance level specified by the manufacturer, when the apparatus is used as intended.
- B. The apparatus shall continue to operate as intended after the test. No degradation of performance or loss of function is allowed below a performance level specified by the manufacturer, when the apparatus is used as intended. The performance level may be replaced by a permissible loss of performance. During the test, degradation of performance is however allowed.
- C. Temporary loss of function is allowed, provided the function is self-recoverable or can be restored by the operation of the controls.

9 TEST RESULTS

Environmental Phenomena	Test Specification	Units	Performance Criteria
Magnetic Field	1	A/m	A

9.1 Model : SE01

9.2 Final Results : PASSED

9.3 Remark :

10 Photos of test configuration please refer to appendix A.

VOLTAGE DIPS, SHORT INTERRUPTIONS IMMUNITY TEST

1 TEST PROCEDURE

According To **IEC 61000-4-11 (2004)**

According To **EN 55024 (1998) + A1 (2001) + A2 (2003)**

2 RESULT OF VOLTAGE DIPS, SHORT INTERRUPTIONS IMMUNITY TEST

N/A (This standard is not applicable to this EUT (Model : SE01)).



HomeTek Technology Inc.

Appendix A

PHOTOS OF TEST CONFIGURATION

PHOTO OF RADIATED EMISSION TEST

Model : SE01



Front View

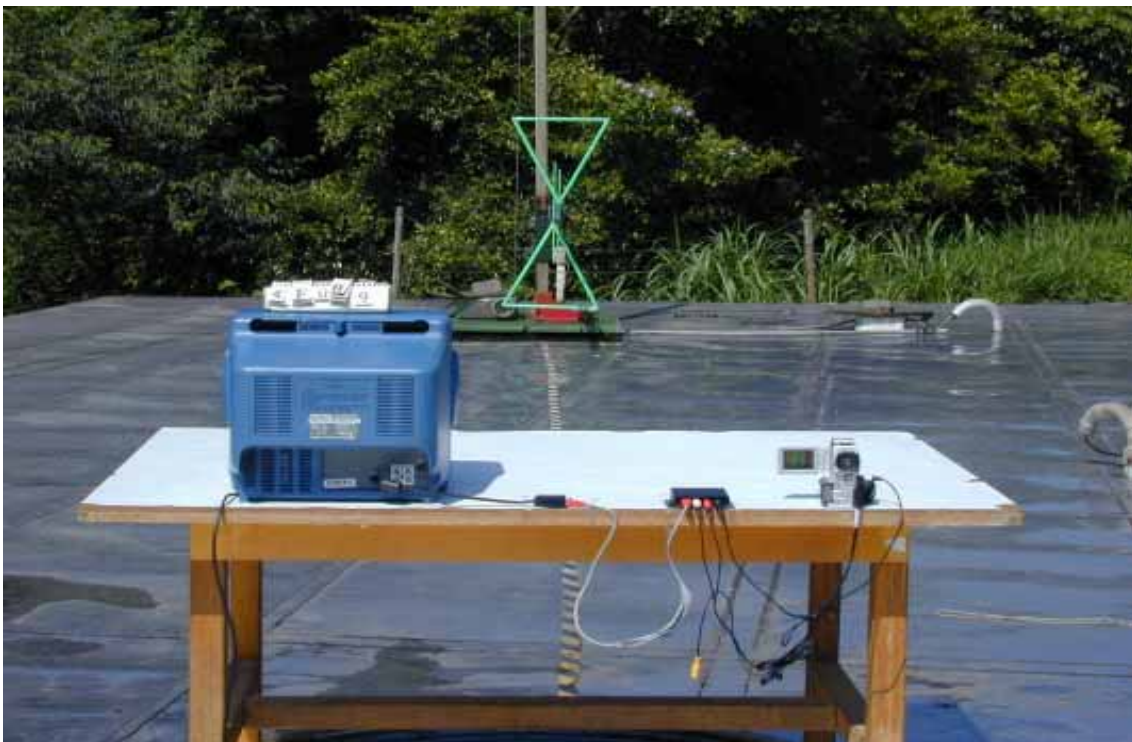

Rear View

PHOTO OF ELECTROSTATIC DISCHARGE IMMUNITY TEST (ESD)

Model : SE01



PHOTO OF POWER FREQUENCY MAGNETIC FIELD IMMUNITY TEST



PHOTO OF RADIO FREQUENCY ELECTROMAGNETIC FIELD IMMUNITY TEST (RS)

Model : SE01





HomeTek Technology Inc.

Appendix B

PHOTOS OF EUT

PHOTO OF EUT

Model : SE01



Full View of EUT

PHOTO OF EUT

Model : SE01

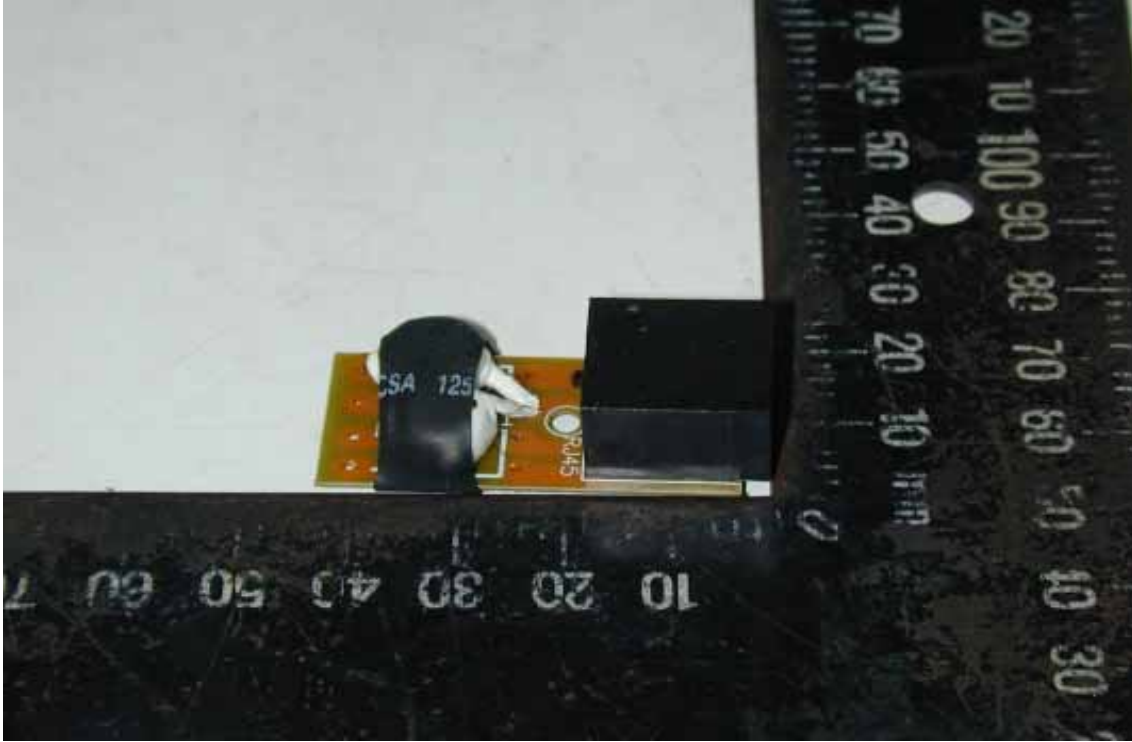

Component Side of Main Board

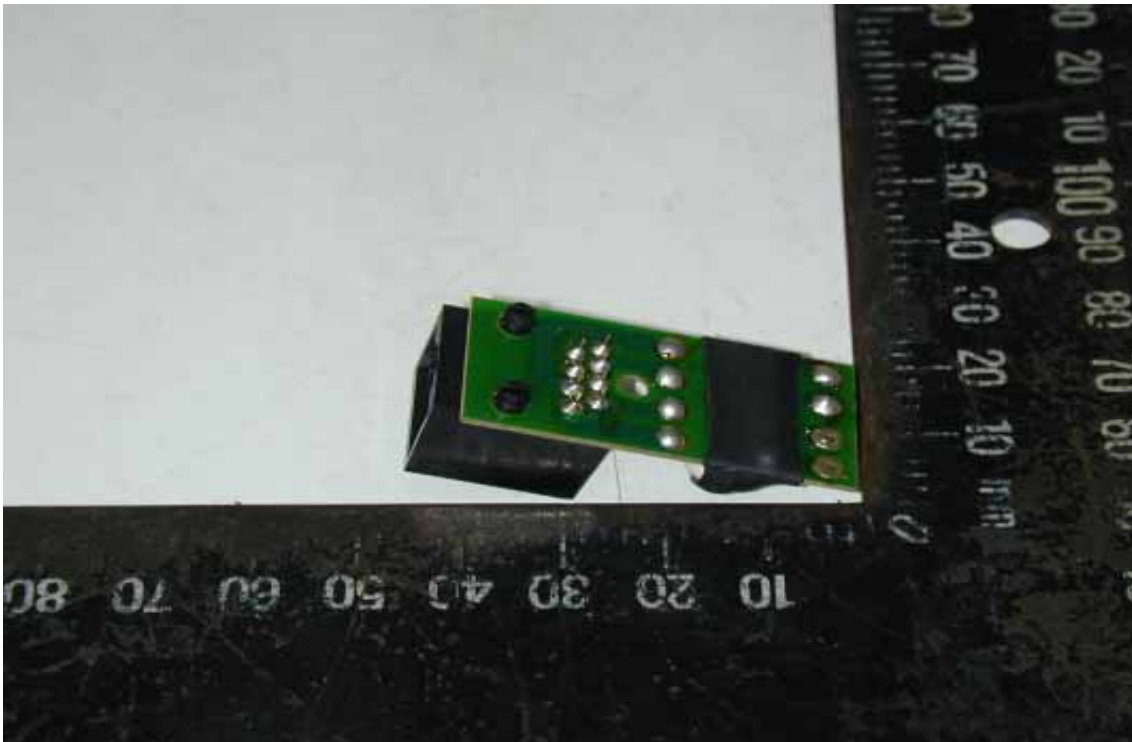

Solder Side of Main Board

Declaration of Conformity

We(Manufacturer/Importer)

(company name)

(address)

declares under our sole responsibility that the product

Product name : CAT5 AV Multimedia Transmission

Model No. : SE0XXX

to which this declaration relates is in conformity with the following standard(s) or other normative document(s)

- | | |
|---|---|
| <input checked="" type="checkbox"/> EN 55022 Class B (1998) | <input checked="" type="checkbox"/> EN 55024 (1998) |
| + A1 (2000) | + A1 (2001) |
| + A2 (2003) | + A2 (2003) |
| <input checked="" type="checkbox"/> EN 61000-3-2 (2000) | <input checked="" type="checkbox"/> IEC 61000-4-2 (2001) |
| <input checked="" type="checkbox"/> EN 61000-3-3 (1995) | <input checked="" type="checkbox"/> IEC 61000-4-3 (2002) |
| + A1 (2001) | <input checked="" type="checkbox"/> IEC 61000-4-4 (2004) |
| | <input checked="" type="checkbox"/> IEC 61000-4-5 (2001) |
| | <input checked="" type="checkbox"/> IEC 61000-4-6 (2003) |
| | + A1 (2004) |
| | <input checked="" type="checkbox"/> IEC 61000-4-8 (2001) |
| | <input checked="" type="checkbox"/> IEC 61000-4-11 (2004) |

following the provisions of 2004/108/EC Directive

Place: _____ Signature: _____

Date : _____ Full name: _____



Title: _____



TÜV Rheinland Taiwan Ltd.

Certificate

of

Appointment

for the applicant:

Hometek Technology Inc.
No. 67-9, Shir Men Rd., Tu-Cheng City,
Taipei Hsien 236, Taiwan, R.O.C.

has been authorized to carry out EMC tests by order and under supervision of TÜV Rheinland. It has successfully demonstrated capability to conduct measurement and to process test data according to:

**European and International EMC Standards as listed in the
Scope of Authorization on the attachment to this certificate**

An assessment of the facility was conducted by TÜV Rheinland auditors according to the TÜV Rheinland requirements for "Test Site Approval" with reference to

ISO 17 025:1999

Certificate No. : 10012161-2006

Valid until : June 14, 2007

TÜV Rheinland Taiwan Ltd.
Taipei, April 13, 2006

Dipl.-Ing. Andreas Klinker
Certification Body

Dipl.-Ing. Bodo Kretzschmar
Product Safety and Quality



Attachment to
Certificate
of Appointment

SCOPE OF AUTHORIZATION

Hometek Technology Inc.
No. 67-9, Shir Men Rd., Tu-Cheng City,
Taipei Hsien 236, Taiwan, R.O.C.

European Standards

EN 50081-1	EN 61000-3-2	ENV 50140
EN 50081-2	EN 61000-3-3	ENV 50141
EN 50082-1	EN 61000-6-1	ENV 50204
EN 50130-4	EN 61000-6-2	
EN 50091-2	EN 61000-6-3	
EN 55011	EN 61000-6-4	
EN 55013	EN 61000-3-11	
EN 55014-1	EN 61000-4-2	
EN 55014-2	EN 61000-4-3	
EN 55022	EN 61000-4-4	
EN 55024	EN 61000-4-5	
EN 60601-1-2	EN 61000-4-6	
EN 60801	EN 61000-4-8	
EN 60945	EN 61000-4-11	
	EN 61204-3	

International Standards

CISPR 11	IEC 61000-4-2	IEC 61000-3-2
CISPR 13	IEC 61000-4-3	IEC 61000-3-3
CISPR 14-1	IEC 61000-4-4	IEC 61000-3-11
CISPR 14-2	IEC 61000-4-5	IEC 61000-6-1
CISPR 22	IEC 61000-4-6	IEC 61000-6-2
CISPR 24	IEC 61000-4-8	IEC 61000-6-3
	IEC 61000-4-11	IEC 61000-6-4
IEC 801.2	IEC 61000-4-12	IEC 60945
IEC 801.3		
IEC 801.4		

Certificate No. : 10012161-2006

Taipei, April 13, 2006

Dipl.-Ing. Bodo Kretzschmar
Product Safety and Quality



TÜV Rheinland Taiwan Ltd.

Certificate of Appointment

for the applicant:

**Hometek Technology Inc.
No. 67-9, Shir Men Rd., Tu-Cheng City,
Taipei Hsien 236, Taiwan, R.O.C.**

has been authorized to carry out EMC tests by order and under supervision of TÜV Rheinland. It has successfully demonstrated capability to conduct measurement and to process test data according to:

**European and International EMC Standards as listed in the
Scope of Authorization on the attachment to this certificate**

An assessment of the facility was conducted by TÜV Rheinland auditors according to the TÜV Rheinland requirements for "Test Site Approval" with reference to

ISO 17025: 2005

Certificate No. : 10012161-2007

Valid until : Sept. 7, 2008

TÜV Rheinland Taiwan Ltd.
Taipei, June 20, 2007

Dipl.-Ing. Andreas Klinker
Certification Body

Dipl.-Ing. Bodo Kretzschmar
Product Safety and Quality



Attachment to
Certificate

of Appointment

SCOPE OF AUTHORIZATION

Hometek Technology Inc.
No. 67-9, Shir Men Rd., Tu-Cheng City,
Taipei Hsien 236, Taiwan, R.O.C.

European Standards

EN 50081-1	EN 61000-3-3	ENV 50140
EN 50081-2	EN 61000-6-1	ENV 50141
EN 50082-1	EN 61000-6-2	ENV 50204
EN 50130-4	EN 61000-6-3	
EN 50091-2	EN 61000-6-4	
EN 55011	EN 61000-3-11	
EN 55013	EN 61000-4-2	
EN 55014-1	EN 61000-4-3	
EN 55014-2	EN 61000-4-4	
EN 55022	EN 61000-4-5	
EN 55024	EN 61000-4-6	
EN 60601-1-2	EN 61000-4-8	
EN 60801	EN 61000-4-11	
EN 60945	EN 61204-3	
EN 61000-3-2	EN 62040-2	

International Standards

CISPR 11	IEC 61000-4-2	IEC 61000-3-2
CISPR 13	IEC 61000-4-3	IEC 61000-3-3
CISPR 14-1	IEC 61000-4-4	IEC 61000-3-11
CISPR 14-2	IEC 61000-4-5	IEC 61000-6-1
CISPR 22	IEC 61000-4-6	IEC 61000-6-2
CISPR 24	IEC 61000-4-8	IEC 61000-6-3
IEC 801.2	IEC 61000-4-11	IEC 61000-6-4
IEC 801.3	IEC 61000-4-12	IEC 60945
IEC 801.4		IEC 62040-2

Certificate No. : 10012161-2007

Taipei, June 20, 2007

Dipl.-Ing. Bodo Kretzschmar
Product Safety and Quality