

HomeTek Technology Inc.

ADDRESS: No. 67-9, Shir Men Road, Tu Cheng City,  
Taipei Hsien, Taiwan,  
PHONE : 886-2-22608375 FAX : 886-2-22748013  
E - mail : hometek@ms15.hinet.net



NVLAP Lab Code:200331-0

## EMI TEST REPORT FOR

APPLICANT : SMART CABLING & TRANSMISSION CORP.  
ADDRESS : 10F, No. 493, Chung-Cheng Rd.,  
Hsin Tien City, Taipei 231, Taiwan, R. O. C.  
EUT : 1 input 9 output video & audio CAT5 distribution  
amplifier  
MODEL NO. : TDA109AVXXX, CE0XXX, YE0XXX

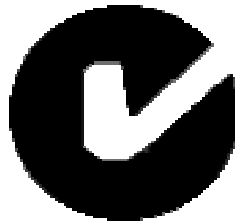

### MEASUREMENT PROCEDURE USED

AS/NZS CISPR 22: 2004 Information technology equipment – Radio disturbance characteristics – Limits and methods of measurement

PREPARED BY :

HomeTek Technology Inc.

No. 67-9, Shir Men Road, Tu Cheng City,

Taipei Hsien. Taiwan

Report # : AS6E016



**TABLE OF CONTENTS**..... 2

**CERTIFICATE** ..... 3

**GENERAL INFORMATION**..... 4

**MODIFICATION LIST**..... 5

**CONDUCTED POWER LINE TEST** ..... 6

1 TEST INSTRUMENTS & FACILITIES..... 6

2 TEST PROCEDURE..... 6

3 TEST SETUP ..... 7

4 CONFIGURATION OF THE EUT ..... 9

5 EUT OPERATING CONDITION..... 14

6 LIMIT OF CONDUCTED POWER LINE EMISSION CLASS B..... 15

7 RESULT OF CONDUCTED POWER LINE TEST..... 15

8 CONDUCTED POWER LINE TEST DATA (PAGE 1)..... 16

9 CONDUCTED POWER LINE TEST DATA (PAGE 2)..... 17

10 CONDUCTED POWER LINE TEST DATA (PAGE 3)..... 18

11 CONDUCTED POWER LINE TEST DATA (PAGE 4)..... 19

12 CONDUCTED POWER LINE TEST DATA (PAGE 5)..... 20

13 CONDUCTED POWER LINE TEST DATA (PAGE 6)..... 21

**RADIATED EMISSION TEST**..... 22

1 TEST INSTRUMENTS & FACILITIES..... 22

2 TEST PROCEDURE..... 23

3 TEST SETUP ..... 23

4 CONFIGURATION OF THE EUT ..... 25

5 EUT OPERATING CONDITION..... 25

6 LIMIT OF RADIATED EMISSION CLASS B ..... 25

7 RESULT OF RADIATED EMISSION TEST..... 25

8 RADIATED EMISSION TEST DATA (PAGE 1)..... 26

9 RADIATED EMISSION TEST DATA (PAGE 2)..... 27

**APPENDIX A**

PHOTOS OF TEST CONFIGURATION

**APPENDIX B**

PHOTOS OF EUT

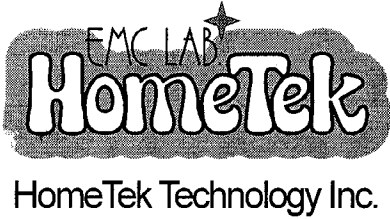

ADDRESS: No. 67-9, Shir Men Road, Tu Cheng City,  
Taipei Hsien, Taiwan  
PHONE : 886-2-22608375 FAX : 886-2-22748013  
E - mail : hometek@ms15.hinet.net



## CERTIFICATE

APPLICANT : SMART CABLING & TRANSMISSION CORP.  
ADDRESS : 10F, No. 493, Chung-Cheng Rd.,  
Hsin Tien City, Taipei 231, Taiwan, R. O. C.  
Receipt Date : 05/15/2007 Final Test Date: 05/18/2007  
EUT : 1 input 9 output video & audio CAT5 distribution  
amplifier  
MODEL NO. : TDA109AVXXX, CE0XXX, YE0XXX

### MEASUREMENT PROCEDURE USED :

AS/NZS CISPR 22: 2004 Information technology equipment – Radio  
disturbance characteristics – Limits and methods of measurement

- THE MAXIMUM EMISSION LEVELS WERE COMPARED TO THE CISPR 22 CLASS B LIMITS BOTH RADIATED AND CONDUCTED EMISSION.
- THE ABOVE DEVICE WAS TESTED BY HOMETEK TECHNOLOGY INC. TO SHOWS THE MAXIMUM EMISSION LEVEL FROM THE DEVICE.
- THIS TEST RESULTS OF THIS REPORT APPLIES TO ABOVE TESTED SAMPLE ONLY.
- THIS TEST REPORT SHALL NOT BE REPRODUCE IN PART WITHOUT WRITTEN APPROVAL OF HOMETEK TECHNOLOGY INC.
- THE REPORT MUST NOT BE USED BY THE CLIENT TO CLAIM PRODUCT ENDORSEMENT BY NVLAP, NIST OR ANY AGENCY OF THE U. S. GOVERNMENT.
- THE TEST RESULTS ARE TRACEABLE TO THE NATIONAL OR INTERNATIONAL STANDARD.

APPROVED BY :

ALAIN LIN / Supervisor

## GENERAL INFORMATION

- 1 APPLICANT : SMART CABLING & TRANSMISSION CORP.
- 2 ADDRESS : 10F, No. 493, Chung-Cheng Rd.,  
Hsin Tien City, Taipei 231, Taiwan, R. O. C.
- 3 MANUFACTURER : SMART CABLING & TRANSMISSION CORP.
- 4 ADDRESS : 10F, No. 493, Chung-Cheng Rd.,  
Hsin Tien City, Taipei 231, Taiwan, R. O. C.
- 5 DESCRIPTION OF EUT :
- EUT : 1 input 9 output video & audio CAT5 distribution amplifier
- Model Number : TDA109AVXXX, CE0XXX, YE0XXX
- Serial # : N/A

5.1 The difference among series of models TDA109AVXXX, CE0XXX and YE0XXX are different in OEM manufacture and other as shown below:

- (1) The first and second “X” represents different system input.
- (2) The third “X” represent different accessory.

The PCB layout is similar. The worst case of EMI test data were shown in this test report.

- 6 FEATURES OF EUT :

**Please refer to user manual or product specification.**



**MODIFICATION LIST**

THE FOLLOWING ACCESSORIES WERE ADDED TO THE EUT DURING TESTING :

NO MODIFICATION BY HOMETEK TECHNOLOGY INC.

## CONDUCTED POWER LINE TEST

### 1 TEST INSTRUMENTS & FACILITIES

The following test Instruments was used during the conducted test :

Item	Instruments/ Facilities	Specification	Manufacturer	Model # S/N	Date Of Cal.
1	EMI Receiver	9KHz ~ 30MHz	ROHDE & SCHWARZ	ESHS 30 844827/007	FEB/2007
2	LISN (for EUT)	50Ω/50uH/100A 150KHz ~ 30MHz	SCHWARZ BECK	NNLK 8121 8121370	OCT/2006
3	LISN (for Support Unit)	50Ω/50uH/10A 9KHz ~ 30MHz	ROHDE & SCHWARZ	ESH3-Z5 846128/007	MAR/2007
4	Terminator	50Ω	N/A	N/A	NOV/2006
5	Attenuation	50Ω/10dB	Mini-Circuit	NAT-10 AT-002	JUL/2006
6	Cable	5.4m	SUHNER	RG-223 CON2-002	AUG/2006
7	ESXS-K1 (software)	Version 2.03b 9KHz ~ 30MHz	ROHDE & SCHWARZ	1082.9678.02 840.913/246	N/A

Note : Items 1 ~ 6 were calibrated within period of 1 year.

### 2 TEST PROCEDURE

- 2.1 The EUT was tested according to **AS/NZS CISPR 22**.
- 2.2 The EUT was placed 0.4 meter from the conducting wall of shielding room and kept at least 0.8 meter from any other grounded conducting surface.
- 2.3 The frequency range form 0.15 MHz to 30 MHz was investigated.
- 2.4 The LISN used was 50 Ohm / 50 uHenry as specified of **AS/NZS CISPR 22**.
- 2.5 All the support peripherals are connect to the other LISN.
- 2.6 Cables and peripherals were moved to find the maximum emission levels for each frequency.

### 3 TEST SETUP

#### 3.1 Typical : Setup Of Conducted Test

ELECTRICAL AND ELECTRONIC EQUIPMENT IN THE RANGE OF 9kHz TO 40 GHz AS/NZS CISPR 22

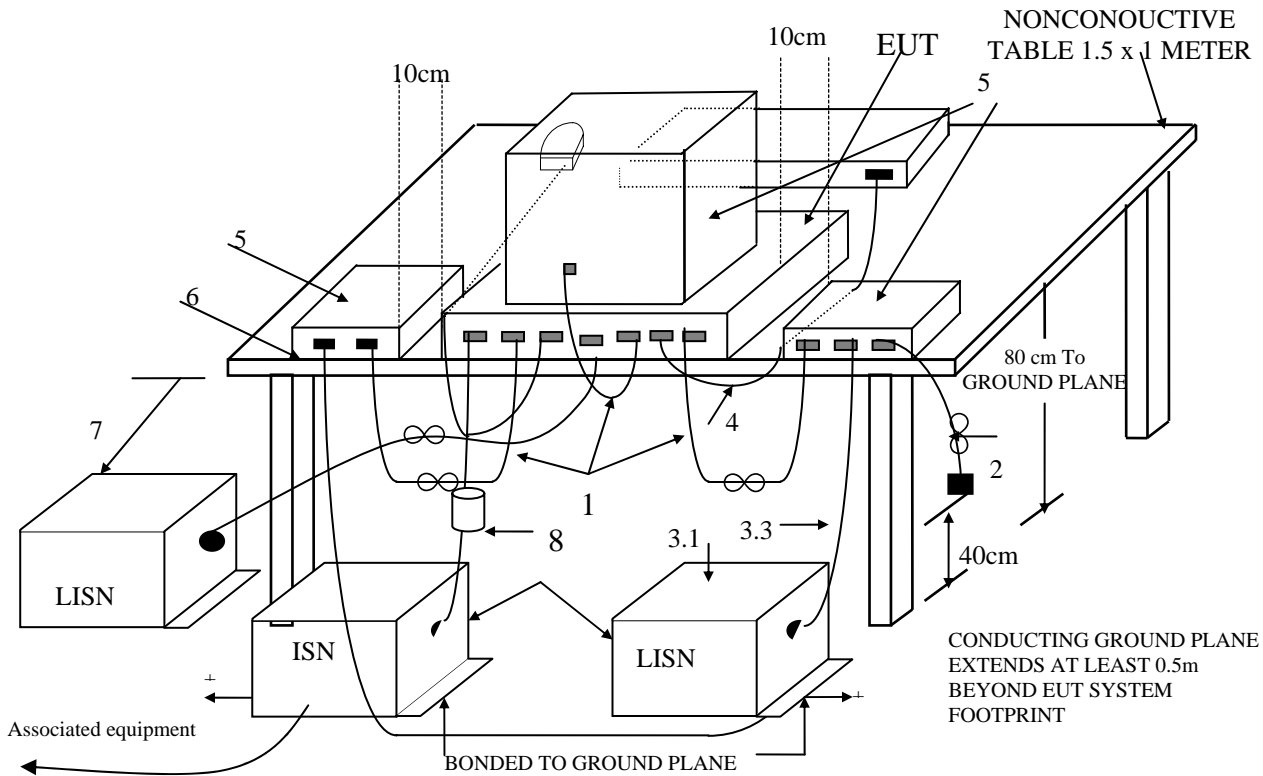

+LISNs may have to be moved to the side to meet 3.3 below.

(Details for setup configuration, please refer to appendix A.)

#### LEGEND:

1. If cables, which hang closer than 40 cm to the horizontal metal groundplane, cannot be shortened to appropriate length, the excess shall be folded back and forth forming a bundle 30 cm to 40 cm long.
2. Excess mains cord shall be bundled in the centre or shortened to appropriate length.
3. EUT is connected to one artificial mains network (AMN). All AMNs and ISNs may alternatively be connected to a vertical reference plane or metal wall.
  - 3.1 All other units of a system are powered from a second AMN. A multiple outlet strip can be used for multiple mains cords.
  - 3.2 AMN and ISN are 80 cm from the EUT and at least 80 cm from other units and other metal planes.
  - 3.3 Mains cords and signal cables shall be positioned for their entire lengths, as far as possible, at 40 cm from the vertical reference plane.
4. Cables of hand-operated devices, such as keyboards, mice, etc., have to be placed as close as for normal usage.
5. Peripherals shall be placed at a distance of 10 cm from each other and from the controller, except for the monitor which, if this is an acceptable installation practice, shall be placed directly on the top of the controller.
6. I/O signal cable intended for external connection.
7. The end of the I/O signal cables which are not connected to an AE may be terminated, if required, using correct terminating impedance.
8. If used, the current probe shall be placed at 0.1 m from the ISN.

#### Test Configuration Tabletop Equipment Conducted Emission

### 3.2 Block Diagram Of Conducted Test

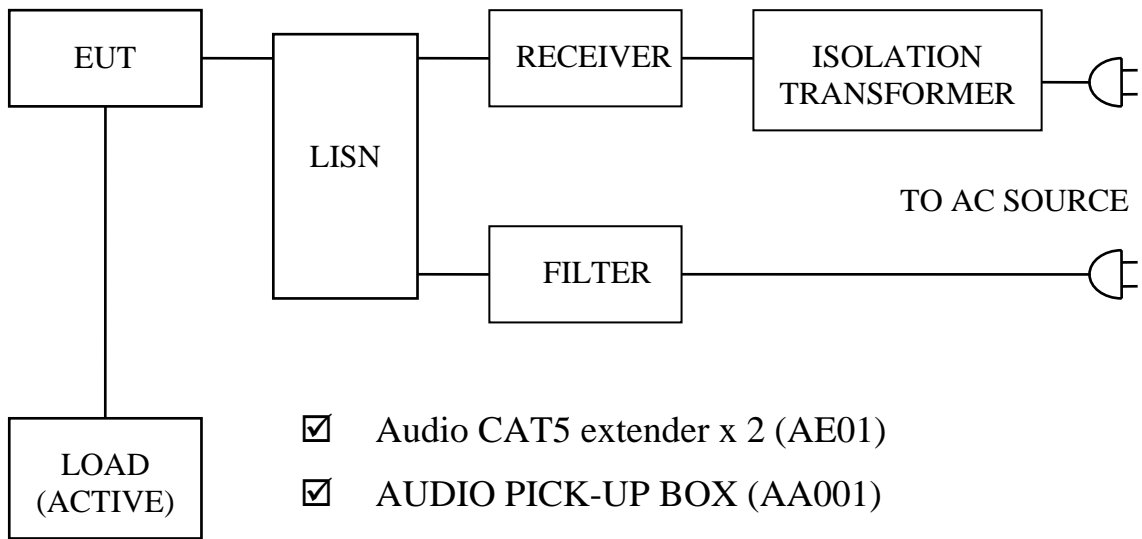

- Audio CAT5 extender x 2 (AE01)
- AUDIO PICK-UP BOX (AA001)
- Twisted Pair 1 input to 2 Output Video Distributor (TDA102)
- Wall Plate Audio & Video CAT5 Extender (CW01AV)
- Video & Audio Transceiver (TTP111AV)
- CCD Camera
- TV
- Power Adapter

#### 4 CONFIGURATION OF THE EUT

The EUT was configured according to **AS/NZS CISPR 22**. All I/O ports were connected to the appropriate peripherals. All peripherals and cables are listed below (including internal device) :

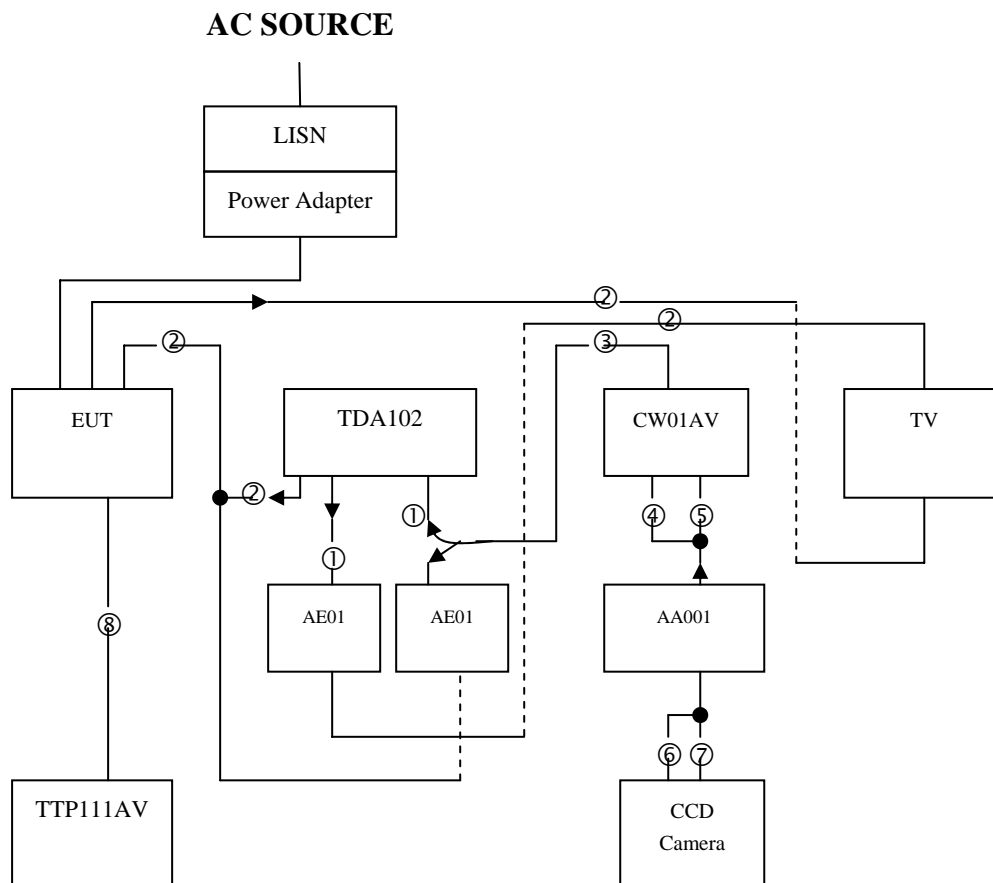

- ① Data Cable
- ② AV Cable
- ③ RJ-45 Cable
- ④ Audio Out Cable
- ⑤ Video Out Cable
- ⑥ Video In Cable
- ⑦ Power Cable
- ⑧ RJ-45 Cable x 9

Figure 1



#### 4.1 EUT

EUT Type : Proto Type Engineer Type Mass Production  
Condition when received : Good Damage : \_\_\_\_\_  
Device : 1 input 9 output video & audio CAT5 distribution amplifier  
Applicant : SMART CABLING & TRANSMISSION CORP.  
Manufacturer : SMART CABLING & TRANSMISSION CORP.  
Model Number : TDA109AVXXX, CE0XXX, YE0XXX  
Serial Number : N/A  
FCC ID : N/A  
Audio In Port x 2 : Metal Type Connector  
Video In Port : Metal Type Connector  
Audio Out Port x 2 : Metal Type Connector  
Video Out Port : Metal Type Connector  
RJ-45 Port x 9 : Plastic Type Connector  
Power Cord (AC) : 2 pin  
Power Cord (DC) : Un-Shielded, 1.8 m, 2 pin  
Power Supply Type : Linear Adapter

#### 4.2 PERIPHERALS

AUDIO PICK-UP BOX

Manufacturer : SMART CABLING & TRANSMISSION CORP.  
Model Number : AA001  
Serial Number : N/A  
FCC ID : N/A  
Data Cable 1 : Un-Shielded, 0.5 m, Connected to the AV Out port  
Data Cable 2 : Un-Shielded, 0.3 m, Connected to the Video port  
Data Cable 3 : Un-Shielded, 0.5 m, Connected to the Power Output port  
Power Cord : N/A



## HomeTek Technology Inc.

Audio CAT5 extender x 2

Manufacturer : SMART CABLING & TRANSMISSION CORP.  
Model Number : AE01  
Serial Number : N/A  
FCC ID : N/A  
Data Cable 1 : Un-Shielded, 0.1 m, Connected to the Video In port  
Data Cable 2 : Un-Shielded, 0.1 m, Connected to the Video Out port  
Data Cable 3 : Shielded, 1.6 m, Connected to the AV In port  
Data Cable 4 : Shielded, 1.6 m, Connected to the AV Out port  
Power Cord : N/A

Twisted Pair 1 input to 2 Output Video Distributor

Manufacturer : SMART CABLING & TRANSMISSION CORP.  
Model Number : TDA102  
Serial Number : N/A  
FCC ID : N/A  
Data Cable 1 : Un-Shielded, 0.1 m, Connected to the Video In port  
Data Cable 2 : Un-Shielded, 0.1 m, Connected to the Video Out port  
Data Cable 3 : Shielded, 1.6 m, Connected to the Video Out port  
Power Cord & Adaptor : Un-Shielded, 1.8 m

Wall Plate Audio & Video CAT5 Extender

Manufacturer : SMART CABLING & TRANSMISSION CORP.  
Model Number : CW01AV  
Serial Number : N/A  
FCC ID : N/A  
Data Cable 1 x 2 : Un-Shielded, 0.5 m, Connected to the AV Out port  
Data Cable 2 : Un-Shielded, 0.3 m, Connected to the RJ-45 port  
Power Cord (DC) : N/A



Video & Audio Transceiver

Manufacturer : SMART CABLING & TRANSMISSION CORP.  
Model Number : TTP111AV  
Serial Number : N/A  
FCC ID : N/A  
Data Cable x 9 : Un-Shielded, 10 m, Connected to the RJ-45 port  
Power Cord (DC) : N/A

CCD Camera

Manufacturer : Comedar  
Model Number : CM-930  
Serial Number : N/A  
FCC ID : N/A  
Data Cable 1 : Un-Shielded, 0.3 m, Connected to the Video port  
Data Cable 2 : Un-Shielded, 0.5 m, Connected to the Power Output port  
Power Cord : N/A

TV

Manufacturer : TCL  
Model Number : 1419A  
Serial Number : 010019502035F0039  
FCC ID : N/A  
Data Cable 1 : Shielded, 1.2 m, Connected to the AV Out port  
Data Cable 2 : Shielded, 1.6 m, Connected to the AV Out port  
Power Cord (DC) : Un-Shielded, 1.8 m



Power Adapter

Manufacturer	: YUH AN
Model Number	: ADP2011-2
Serial Number	: N/A
FCC ID	: N/A
Data Cable	: N/A
Power Cord (DC)	: Un-Shielded, 1.8 m

4.3 REMARK : N/A

## 5 EUT OPERATING CONDITION

5.1 The frequency of the EUT is none.

5.2 Configure the EUT according to the **AS/NZS CISPR 22**.

5.3

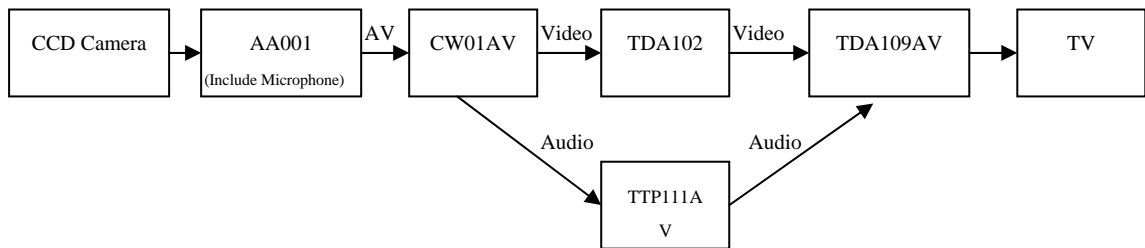

5.4 CCD camera & AA001 send audio and video signals to CW01AV, TTP111AV, TDA102, TDA109AV, and CW01AV, TTP111AV, TDA102, TDA109AV change audio and video signals.

5.5 Then has changed audio and video signals send to TV display.

5.6 Measure the maximum emission noise.

**5.7 The photos of conducted test configuration, please refer to appendix A.**

## 6 LIMIT OF CONDUCTED POWER LINE EMISSION CLASS B

### AS/NZS CISPR 22

Frequency Range	Quasi Peak	Average
0.15 ~ 0.5 MHz	66 - 56 dBuV	56 - 46 dBuV
0.5 ~ 5 MHz	56 dBuV	46 dBuV
5 ~ 30 MHz	60 dBuV	50 dBuV

6.1 In the above table, the tighter limit applies at the band edges.

## 7 RESULT OF CONDUCTED POWER LINE TEST

7.1 The frequency range from 0.15 MHz to 30 MHz was investigated. All readings are quasi-peak values and average.

7.2 IF bandwidth : 9 kHz, Meas Time : 1 sec.

7.3 Temperature : 26 °C, Humidity : 60 % RH.

7.4 Uncertainty in conducted emission measurement : ± 2.90dB.

7.5 The conducted test result were gained by following procedures :

Level = Reading Level + Insertion Loss of LISN + Cable Loss

(All calculation were done by ESHS30 EMI test receiver.)

7.6 Result : **PASSED**

## 8 CONDUCTED POWER LINE TEST DATA (PAGE 1)

HomeTek EMC LAB. TEL :886-2-22608375

15 May 2007 14:31

### CONDUCTED EMISSIONS

EUT: 1 input 9 output video & audio CAT5 distribution amplifier  
 Manuf: 6E016  
 Op Cond: LINE 1  
 Operator: JASON  
 Test Spec: FOR CISPR22 CLASS B  
 Comment: 240V/50Hz  
 TDA109AV  
 Result File: 6e01611g.dat :

Prescan Measurement: Detectors: X PK / + AV  
 Meas Time: see scan settings  
 Subranges: 16  
 Acc Margin: 55 dB

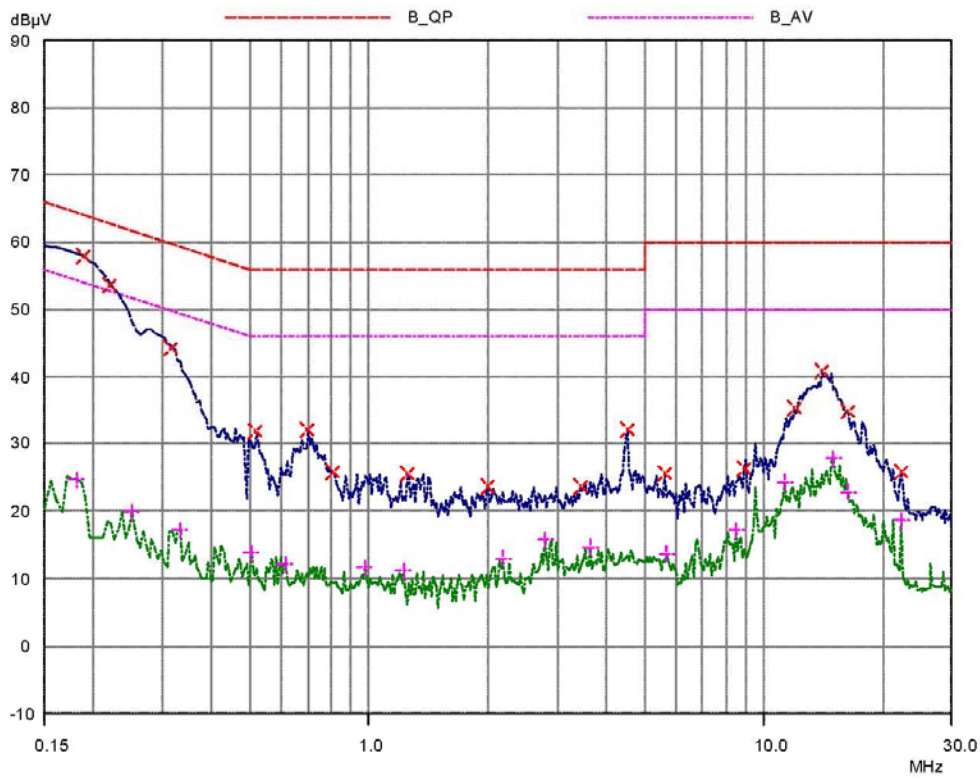



### 9 CONDUCTED POWER LINE TEST DATA (PAGE 2)

HomeTek EMC LAB. TEL :886-2-22608375

15 May 2007 14:31

#### CONDUCTED EMISSIONS

EUT: 1 input 9 output video & audio CAT5 distribution amplifier  
 Manuf: 6E016  
 Op Cond: LINE 1  
 Operator: JASON  
 Test Spec: FOR CISPR22 CLASS B  
 Comment: 240V/50Hz  
 TDA109AV  
 Result File: 6e01611g.dat :

Prescan Measurement: Detectors: X PK / + AV  
 Meas Time: see scan settings  
 Subranges: 16  
 Acc Margin: 55 dB

#### Peak Search Results

Frequency MHz	PK Level dBµV	PK Limit dBµV	PK Delta dB
0.19	57.91	64.04	6.13
0.22	53.70	62.82	9.12
0.315	44.37	59.84	15.47
0.515	31.68	56.00	24.32
0.7	32.11	56.00	23.89
0.81	25.72	56.00	30.28
1.26	25.52	56.00	30.48
2.0	23.67	56.00	32.33
3.43	23.60	56.00	32.40
4.5	31.90	56.00	24.10
5.59	25.60	60.00	34.40
8.92	26.18	60.00	33.82
11.88	35.35	60.00	24.65
14.0	40.79	60.00	19.21
16.32999	34.97	60.00	25.03
22.25	25.78	60.00	34.22

Frequency MHz	AV Level dBµV	AV Limit dBµV	AV Delta dB
0.18	24.58	54.49	29.91
0.25	19.80	51.76	31.96
0.33	17.21	49.45	32.24
0.5	13.75	46.00	32.25
0.61	12.15	46.00	33.85
0.97	11.61	46.00	34.39
1.22	11.21	46.00	34.79
2.17	13.00	46.00	33.00
2.78	15.72	46.00	30.28
3.61	14.63	46.00	31.37
5.64	13.72	50.00	36.28
8.51	17.14	50.00	32.86
11.23	24.29	50.00	25.71
14.95	27.75	50.00	22.25
16.30999	22.81	50.00	27.19
22.25	18.63	50.00	31.37

\* limit exceeded

### 10 CONDUCTED POWER LINE TEST DATA (PAGE 3)

HomeTek EMC LAB. TEL :886-2-22608375

15 May 2007 14:39

**CONDUCTED EMISSIONS**

EUT: 1 input 9 output video & audio CAT5 distribution amplifier  
 Manuf: 6E016  
 Op Cond: LINE 2  
 Operator: JASON  
 Test Spec: FOR CISPR22 CLASS B  
 Comment: 240V/50Hz  
 TDA109AV  
 Result File: 6e01621g.dat :

Prescan Measurement: Detectors: X PK / + AV  
 Meas Time: see scan settings  
 Subranges: 16  
 Acc Margin: 55 dB

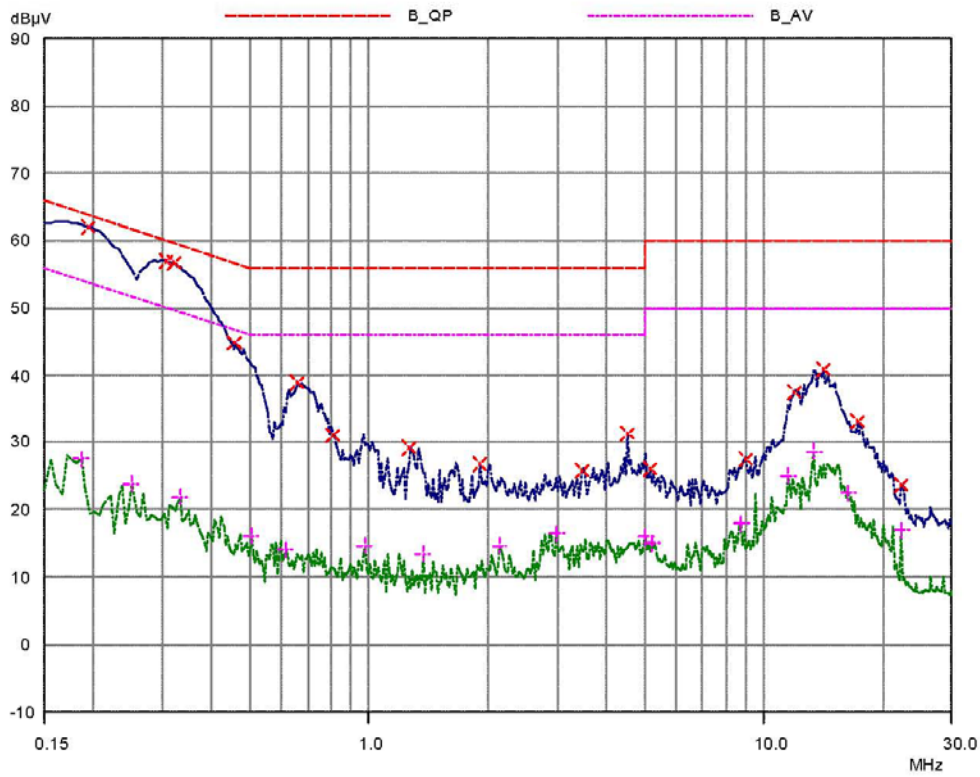



# 11 CONDUCTED POWER LINE TEST DATA (PAGE 4)

HomeTek EMC LAB. TEL :886-2-22608375

15 May 2007 14:39

## CONDUCTED EMISSIONS

EUT: 1 input 9 output video & audio CAT5 distribution amplifier  
 Manuf: 6E016  
 Op Cond: LINE 2  
 Operator: JASON  
 Test Spec: FOR CISPR22 CLASS B  
 Comment: 240V/50Hz  
 TDA109AV  
 Result File: 6e01621g.dat :

Prescan Measurement: Detectors: X PK / + AV  
 Meas Time: see scan settings  
 Subranges: 16  
 Acc Margin: 55 dB

### Peak Search Results

Frequency MHz	PK Level dBµV	PK Limit dBµV	PK Delta dB
0.195	62.09	63.82	1.73
0.305	56.98	60.11	3.13
0.32	56.72	59.71	2.99
0.455	44.86	56.78	11.92
0.66	38.97	56.00	17.03
0.81	31.16	56.00	24.84
1.27	29.13	56.00	26.87
1.91	26.82	56.00	29.18
3.46	25.86	56.00	30.14
4.51	31.26	56.00	24.74
5.13	26.00	60.00	34.00
8.96	27.50	60.00	32.50
11.87	37.61	60.00	22.39
14.13	40.96	60.00	19.04
17.3	33.14	60.00	26.86
22.36	23.65	60.00	36.35

Frequency MHz	AV Level dBµV	AV Limit dBµV	AV Delta dB
0.185	27.48	54.26	26.78
0.25	23.76	51.76	28.00
0.33	21.86	49.45	27.59
0.5	16.07	46.00	29.93
0.61	14.09	46.00	31.91
0.97	14.70	46.00	31.30
1.36	13.51	46.00	32.49
2.14	14.59	46.00	31.41
2.97	16.48	46.00	29.52
4.98	16.00	46.00	30.00
5.18	14.95	50.00	35.05
8.75	17.93	50.00	32.07
11.52	24.95	50.00	25.05
13.38	28.56	50.00	21.44
16.3	22.44	50.00	27.56
22.25	16.91	50.00	33.09

\* limit exceeded

## 12 CONDUCTED POWER LINE TEST DATA (PAGE 5)

HomeTek EMC LAB. TEL :886-2-22608375

15 May 2007 14:41

### CONDUCTED EMISSIONS

EUT: 1 input 9 output video & audio CAT5 distribution amplifier  
 Manuf: 6E016  
 Op Cond: LINE 2  
 Operator: JASON  
 Test Spec: FOR CISPR22 CLASS B  
 Comment: 240V/50Hz  
 TDA109AV  
 Result File: 6e01622g.dat :

Prescan Measurement:    Detector:    X QP  
                                   Meas Time: see scan settings  
                                   Subranges: 16  
                                   Acc Margin: 55 dB

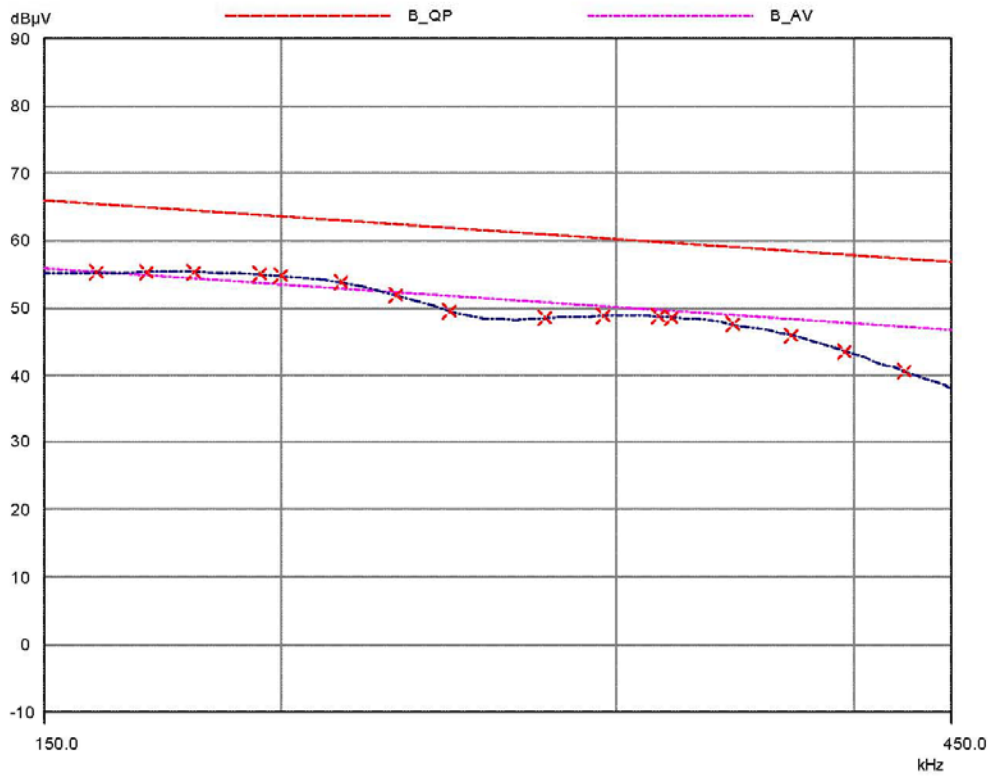



### 13 CONDUCTED POWER LINE TEST DATA (PAGE 6)

HomeTek EMC LAB. TEL :886-2-22608375

15 May 2007 14:41

#### CONDUCTED EMISSIONS

EUT: 1 input 9 output video & audio CAT5 distribution amplifier  
 Manuf: 6E016  
 Op Cond: LINE 2  
 Operator: JASON  
 Test Spec: FOR CISPR22 CLASS B  
 Comment: 240V/50Hz  
 TDA 109AV  
 Result File: 6e01622g.dat :

Prescan Measurement:    Detector:    X QP  
                                  Meas Time:    see scan settings  
                                  Subranges:    16  
                                  Acc Margin:    55 dB

#### Peak Search Results

Frequency kHz	QP Level dBµV	QP Limit dBµV	QP Delta dB
160.0	55.24	65.46	10.22
170.0	55.37	64.96	9.59
180.0	55.34	64.49	9.15
195.0	55.02	63.82	8.80
200.0	54.81	63.61	8.80
215.0	53.81	63.01	9.20
230.0	51.86	62.45	10.59
245.0	49.48	61.92	12.44
275.0	48.55	60.97	12.42
295.0	48.87	60.38	11.51
315.0	48.80	59.84	11.04
320.0	48.68	59.71	11.03
345.0	47.61	59.08	11.47
370.0	45.96	58.50	12.54
395.0	43.63	57.96	14.33
425.0	40.64	57.35	16.71

\* limit exceeded

## RADIATED EMISSION TEST

### 1 TEST INSTRUMENTS & FACILITIES

The following test Instruments was used during the radiated emission test :

Item	Instruments /facilities	Specification	Manufacturer	Model # / S/N#	Date of Cal.
1	OPEN AREA TEST SITE	<input checked="" type="checkbox"/> OATS 3			JUL/2006
2	EMI TEST RECEIVER	20Hz ~ 26.5GHz	ROHDE & SCHWARZ	ESMI 845442/006	FEB/2007
3	PRE-AMPLIFIER	9KHz ~ 3000MHz	ADVANTEST	BB525C 90081001	OCT/2006
4	ANTENNA (BI-LOG)	25MHz ~ 2GHz	SCHAFFNER	CBL6112B S/N : 2614	JUN/2006
5	Attenuation	50Ω/6dB	JYE BAO	FAT-N (M-F) 001	JUL/2006
6	Ferrite Clamp	30 ~ 1000MHz	ADT	FC18 910030	DEC/2006
7	Ferrite Clamp	30 ~ 1000MHz	HomeTek	HFC 001	DEC/2006
8	Cable	10m	SUHNER	RG214/U OS3-003	DEC/2006
9	Cable	14m	BELDEN	9913 OS3-001	DEC/2006
10	EMI 32 (software)	N/A	AUDIX	19991013-0923	N/A

Note : Items 1 ~ 9 were calibrated within period of 1 year.

## 2 TEST PROCEDURE

- 2.1 The EUT was test according to **AS/NZS CISPR 22**.
- 2.2 The radiated test was performed at HomeTek Lab's Open Site **III**.
- 2.3 The frequency range from 30 MHz to 1 GHz, the measurement were made at 10 meters, with a BI-log antenna.

## 3 TEST SETUP

### 3.1 TEST SETUP OF OPEN SITE.

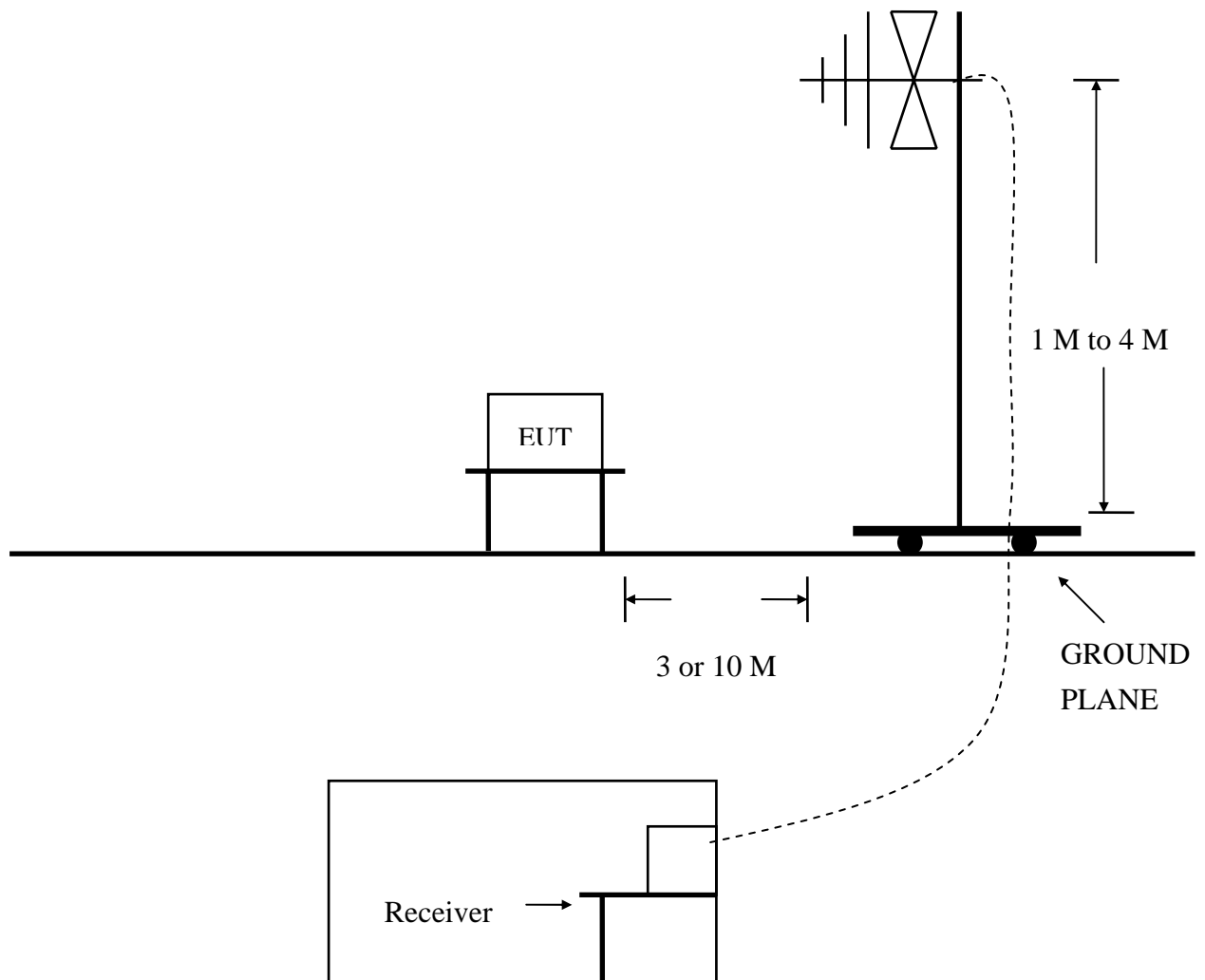

### 3.2 TEST SETUP OF EUT

ELECTRICAL AND ELECTRONIC EQUIPMENT IN THE RANGE OF 9kHz TO 40 GHz AS  
NZS CISPR 22

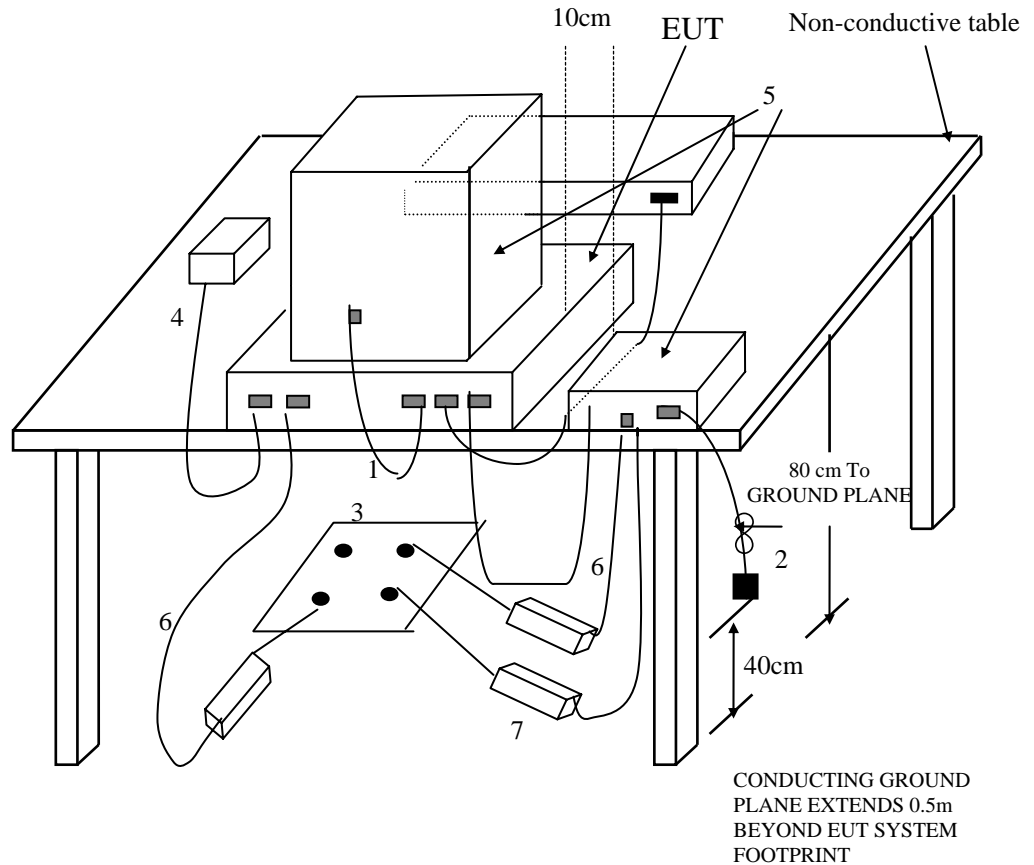

(Details for setup configuration, please refer to appendix A.)

#### LEGEND:

1. If cables, which hang closer than 40 cm to the horizontal metal ground plane cannot be shortened to the appropriate length, the excess shall be folded back and forth forming a bundle 30 cm to 40 cm long.
2. The end of I/O signal cables which are not connected to a peripheral may be terminated, if required for proper operation using correct terminating impedance.
3. Mains junction box(es) shall be flush with, and bonded directly to, the metal ground plane.  
NOTE if used, the AMN shall be installed under the horizontal metal ground plane.
4. Cables of hand-operated devices such as keyboards, mice, etc. shall be placed as for normal usage.
5. Peripherals shall be placed at a distance of 10 cm from each other and from the controller, except for the monitor which, if for an acceptable installation practice, shall be placed directly on top of the controller.
6. Mains cables, telephone lines or other connections to auxiliary equipment located outside the test area shall drape to the floor, be fitted with ferrite clamps or ferrite tubes placed on the floor at the point where the cable reaches the floor and then routed to the place where they leave the turntable. No extension cords shall be used to mains receptacle.
7. Ferrite clamps or ferrite tubes with similar characteristics (as defined in 10.4). No more than one cable per clamp.

#### Test Configuration Tabletop Equipment Radiated Emission

4 CONFIGURATION OF THE EUT

Same as “Conducted Power Line test”, section 5

5 EUT OPERATING CONDITION

5.1 Same as “Conducted Power Line test”, section 5

5.2 The radiated emission in the frequency range from 30 MHz - 1000 MHz was test in a horizontal and vertical polarization at HomeTek Lab’s open site III.

**5.3 The photos of radiated test configuration, please refer to appendix A.**

6 LIMIT OF RADIATED EMISSION CLASS B

AS/NZS CISPR 22

Frequency (MHz)	Measurement Distance	Limit (dBuV/m)
30 - 230	10 (M)	30
230 - 1000	10 (M)	37

6.1 The tighter limit shall apply at the edge between two frequency bands.

6.2 Measurement distance in meters between the measuring instrument antenna and the closed point of any part of the EUT or peripherals.

7 RESULT OF RADIATED EMISSION TEST

7.1 The frequency range from 30 MHz to 1 GHz was investigated.

7.2 All readings below or equal 1 GHz are quasi-peak or peak values with resolution bandwidth of 120 KHz.

7.3 The measurements were made at 10 meters of HomeTek Lab’s open site III.

7.4 Temperature : 29 °C, Humidity : 58 % RH.

7.5 Uncertainty in radiated emission measurement : ± 4.18dB.

7.6 The radiated emission result were gained by the following method :

Level = Reading Level + Probe Factor (Antenna Factor) + Cable Loss – Preamp Factor

Over Limit = Level – Limit Line

7.7 Result : **PASSED**



# 8 RADIATED EMISSION TEST DATA (PAGE 1)



HomeTek Technology Inc.

No 67-9, Shi-Men Rd., Tu-Chen City,  
Taipei County, Taiwan R.O.C.  
Tel: 02-22608375  
Fax: 02-22748013

Data#: 6 File#: 6e016.EMI

Date: 2007-05-16 Time: 17:39:15

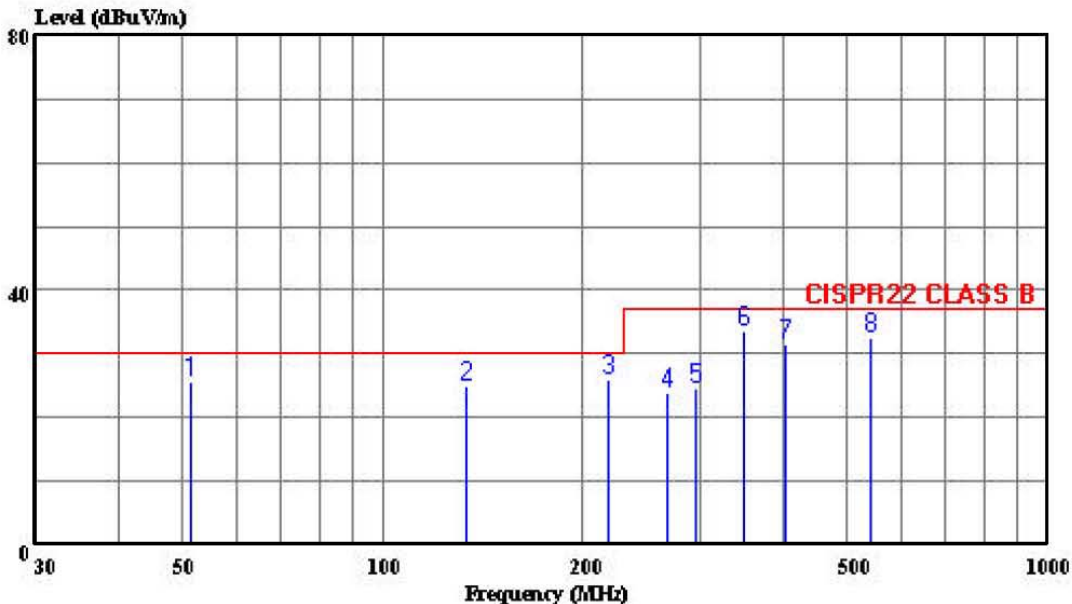

Trace:

Ref Trace:

Condition: CISPR22 CLASS B 10m CHASE 2614 060506 HORIZONTAL  
eut : 1 input 9 output video & audio CAT5  
power: 240V/50Hz  
memo : TDA109AV

Page: 1

Peak #	Freq MHz	Level dBUV/m	Limit dBUV/m	Over Limit dB	ReadAntenna Level dBuV	Cable Factor dB/m	Preamp Loss dB	Remark
1	51.348	25.66	30.00	-4.34	42.35	8.52	0.76	25.97 Peak
2	133.396	24.80	30.00	-5.20	37.44	11.45	1.74	25.83 Peak
3	218.642	25.93	30.00	-4.07	40.27	9.10	2.23	25.68 Peak
4	266.940	23.72	37.00	-13.28	34.07	12.62	2.60	25.56 Peak
5	295.237	24.75	37.00	-12.25	34.47	13.04	2.75	25.51 Peak
6	348.006	33.68	37.00	-3.32	41.50	14.45	3.08	25.36 Peak
7	402.531	31.53	37.00	-5.47	37.62	15.72	3.38	25.19 Peak
8	541.140	32.67	37.00	-4.33	34.17	18.44	4.74	24.68 Peak



9 RADIATED EMISSION TEST DATA (PAGE 2)



HomeTek Technology Inc.

No 67-9, Shi-Men Rd., Tu-Chen City, Taipei County, Taiwan R.O.C. Tel:02-22608375 Fax:02-22748013

Data#: 4 File#: 6e016.EMI

Date: 2007-05-16 Time: 17:06:58

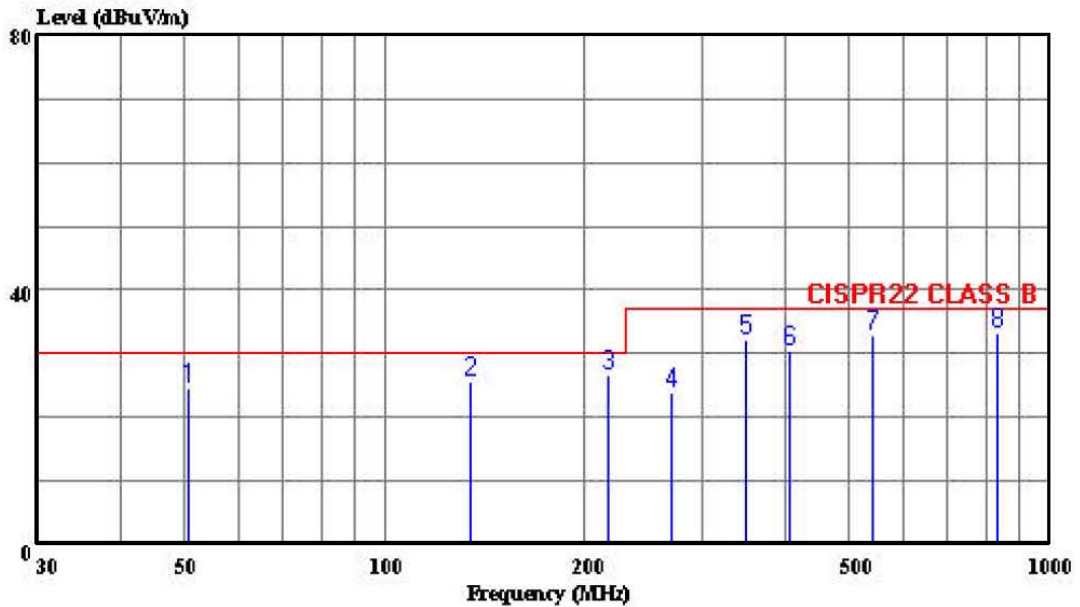

Trace:

Ref Trace:

Condition: CISPR22 CLASS B 10m CHASE 2614 060506 VERTICAL  
eut : 1 input 9 output video & audio CAT5  
power: 240V/50Hz  
memo : TDA109AV

Page: 1

	Limit	Over	ReadAntenna	Cable	Preamp				
Freq	Level	Line	Level	Loss	Factor	Remark			
MHz	dBuV/m	dBuV/m	dB	dB	dB		dB	dB	
1	50.469	24.69	30.00	-5.31	41.37	8.52	0.76	25.97	Peak
2	134.366	25.78	30.00	-4.22	38.42	11.45	1.74	25.83	Peak
3	216.042	26.83	30.00	-3.17	41.17	9.10	2.23	25.68	Peak
4	269.940	24.02	37.00	-12.98	34.37	12.62	2.60	25.56	Peak
5	350.006	32.28	37.00	-4.72	40.10	14.45	3.08	25.36	Peak
6	405.531	30.53	37.00	-6.47	36.62	15.72	3.38	25.19	Peak
7	540.180	32.80	37.00	-4.20	34.30	18.44	4.74	24.68	Peak
8	833.212	33.09	37.00	-3.91	31.50	20.11	5.14	23.66	Peak



HomeTek Technology Inc.

## **Appendix A**

# **PHOTOS OF TEST CONFIGURATION**

## PHOTO OF CONDUCTED POWER LINE TEST

Model : TDA109AV



Front View



Rear View

## PHOTO OF RADIATED EMISSION TEST

Model : TDA109AV



Front View

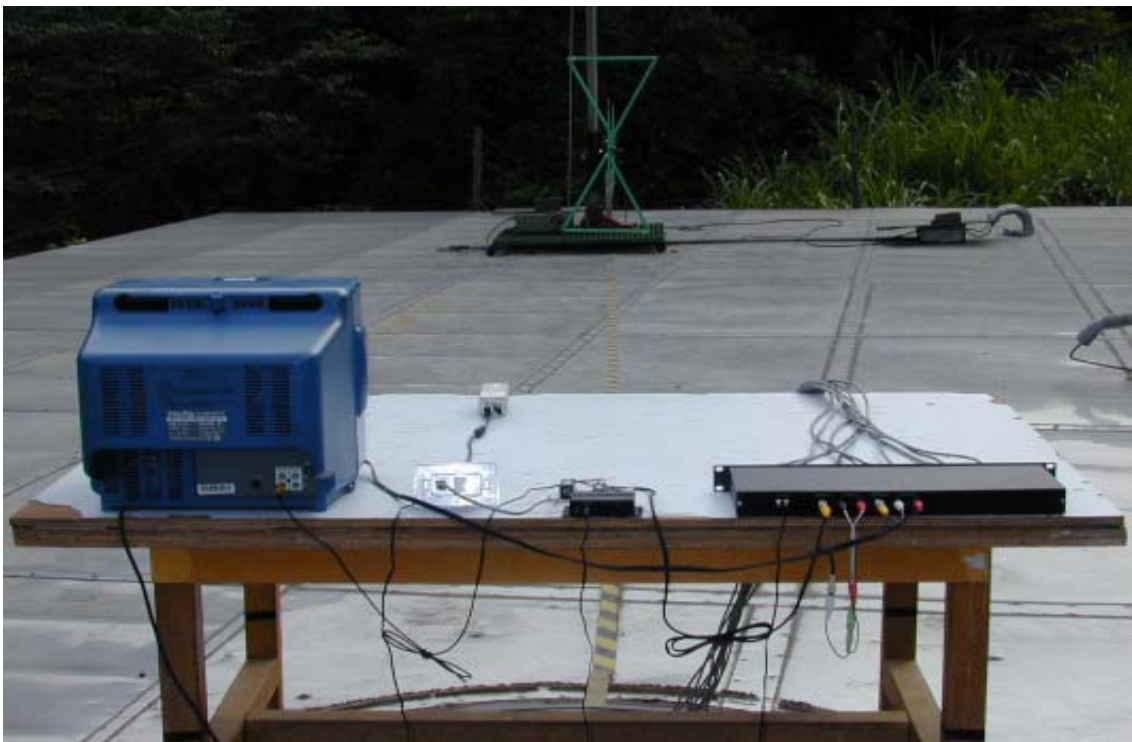

Rear View



HomeTek Technology Inc.

## **Appendix B**

### **PHOTOS OF EUT**

## PHOTO OF EUT

Model : TDA109AVXXX , CE0XXX , YE0XXX



Full View of EUT

## PHOTO OF EUT

Model : TDA109AVXXX , CE0XXX , YE0XXX

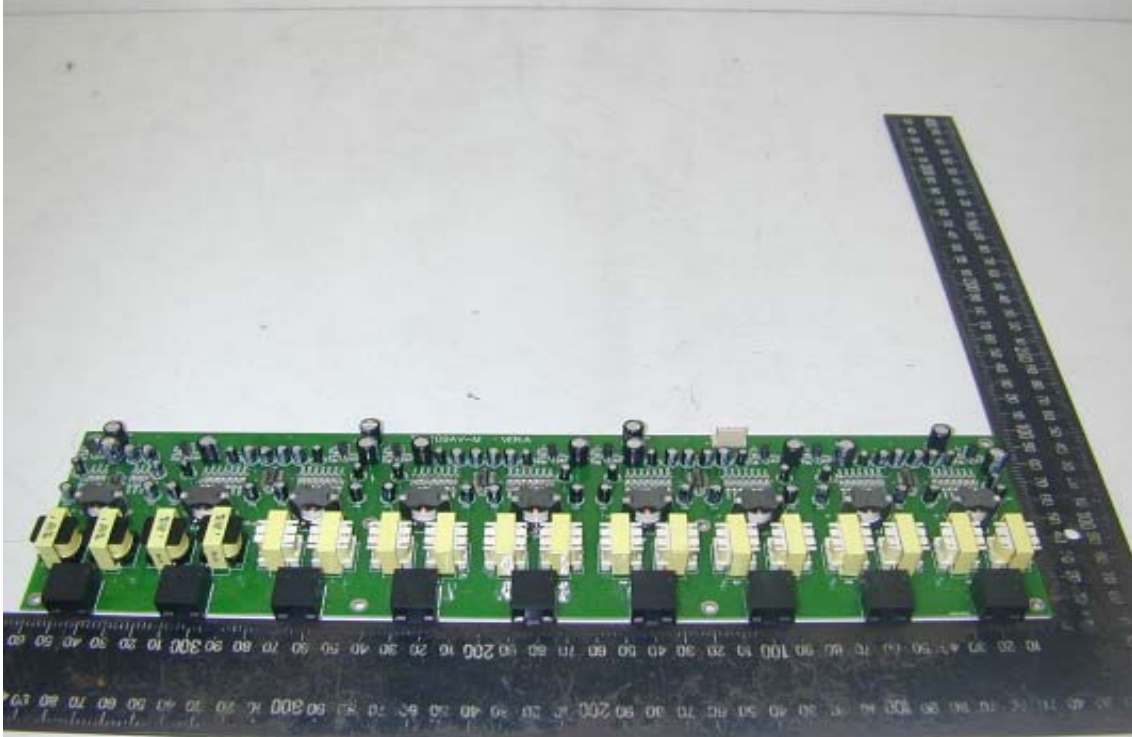

Component Side of Main Board 1

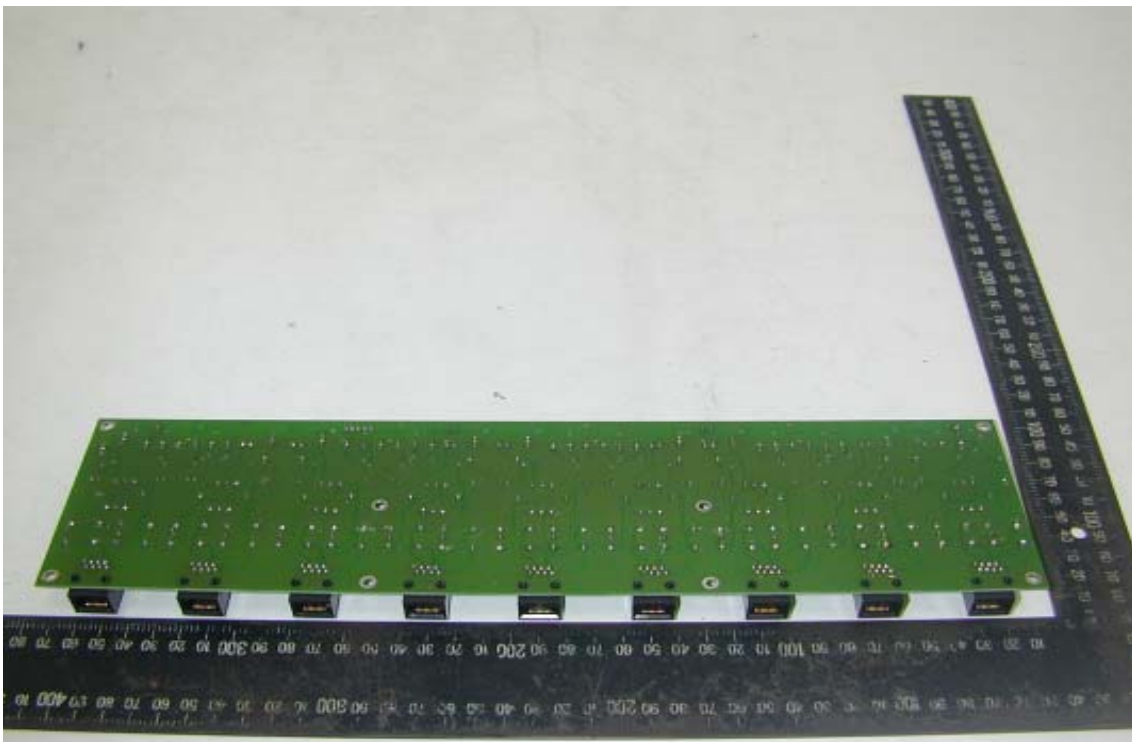

Solder Side of Main Board 1

## PHOTO OF EUT

Model : TDA109AVXXX , CE0XXX , YE0XXX

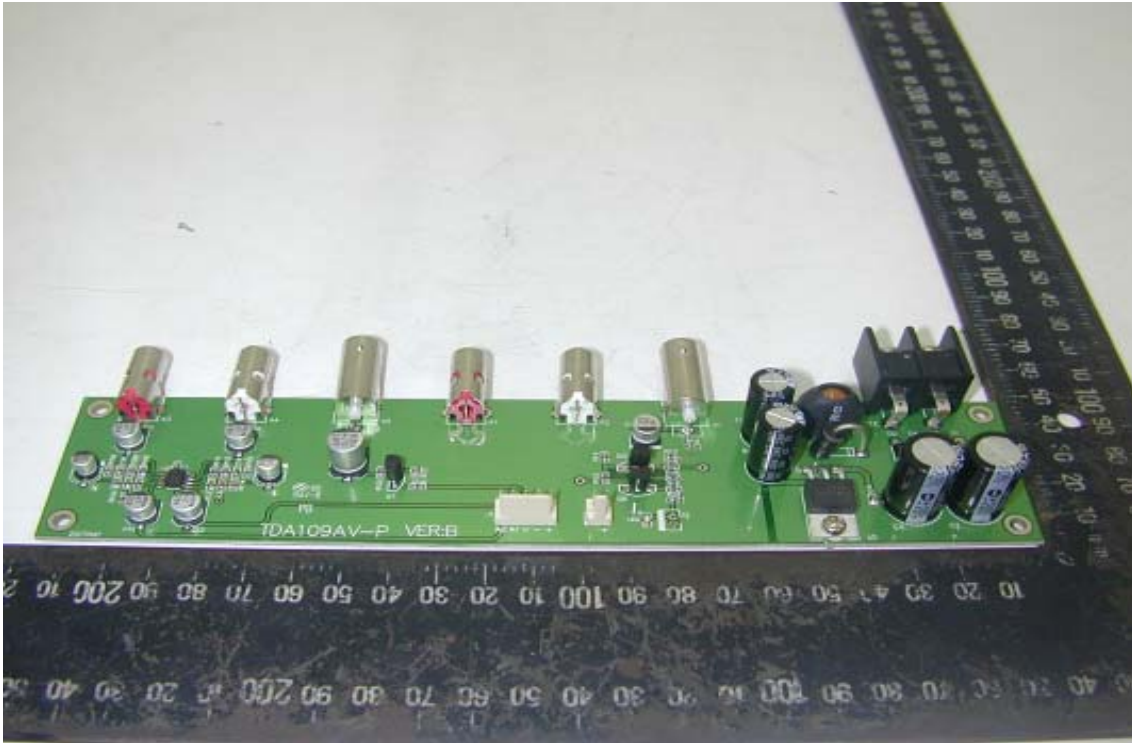

Component Side of Main Board 2

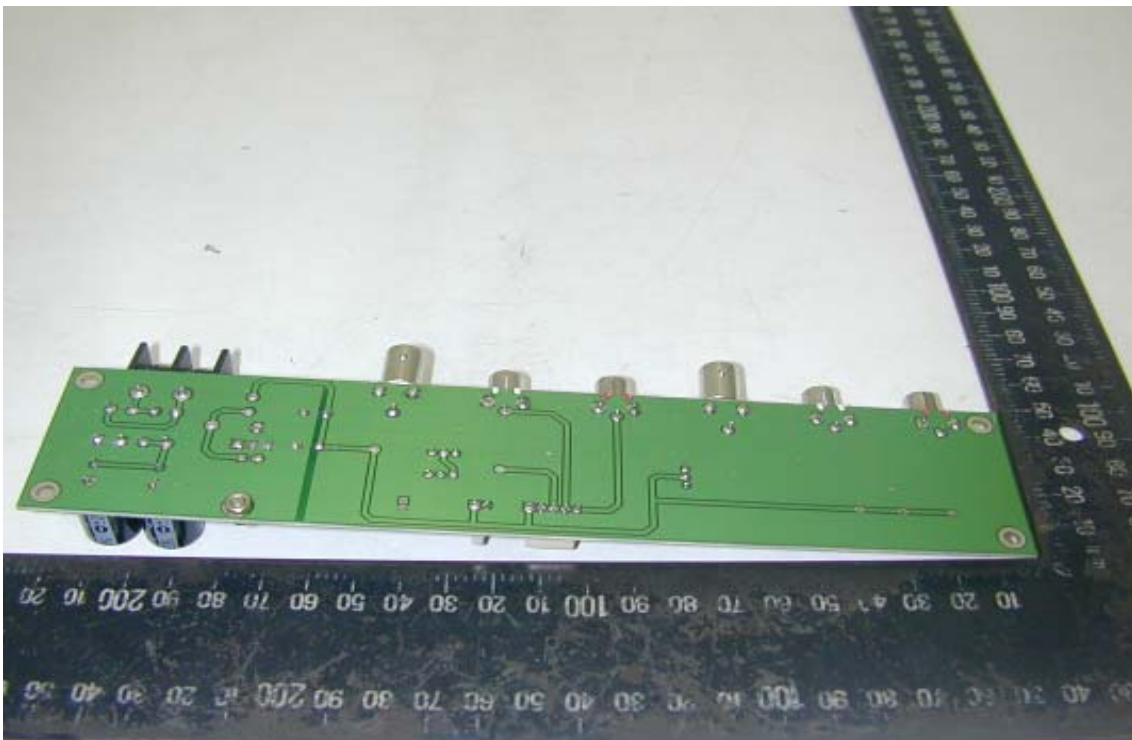

Solder Side of Main Board 2

### PHOTO OF EUT



Front View of Adapter (Model: ADP2411-2)



Rear View of Adapter (Model: ADP2411-2)

# Declaration of Conformity

Responsible Party Name :

Address :

Phone No :

Fax No :

Declares under our sole responsibility that the product

Product Name : 1 input 9 output video & audio CAT5  
distribution amplifier

---

Model No. : TDA109AVXXX, CE0XXX, YE0XXX

---

to which this declaration relates is in conformity with the following standards or other  
normative documents

AS/NZS CISPR 22 (2004) : Electromagnetic Interference  
– Limits and Methods of Measurement of Information Technology Equipment

Representative Person's Name : \_\_\_\_\_

Signature : \_\_\_\_\_

Date : \_\_\_\_\_

United States Department of Commerce  
National Institute of Standards and Technology

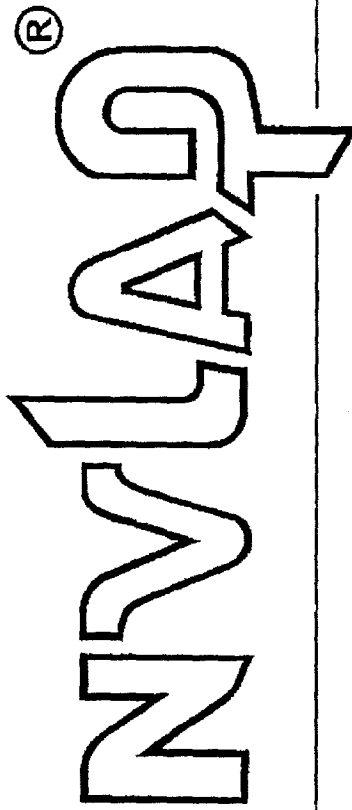

---

## Certificate of Accreditation to ISO/IEC 17025:2005

---

NVLAP LAB CODE: 200331-0

**HomeTek Technology Inc.**

Taipei Shien 236  
TAIWAN

is recognized by the National Voluntary Laboratory Accreditation Program for conformance with criteria set forth in  
NVLAP accreditation documents and all requirements of ISO/IEC 17025:2005.  
Accreditation is granted for specific services, listed on the Scope of Accreditation, for:

**ELECTROMAGNETIC COMPATIBILITY AND TELECOMMUNICATIONS**

2006-10-01 through 2007-09-30

Effective dates

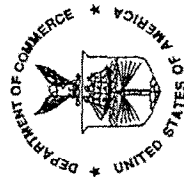

*Dally A. Bruce*  
For the National Institute of Standards and Technology



**National Voluntary  
Laboratory Accreditation Program**



**SCOPE OF ACCREDITATION TO ISO/IEC 17025:2005**

**HomeTek Technology Inc.**  
P.O Box: 13-131, Pan-Chiao City  
No. 67-9 Shir Men Rd., Tu Chen City  
Taipei Shien 236  
TAIWAN  
Mr. Grant Huang  
Phone: 886-2-22608375 Fax: 886-2-22748013  
E-Mail: hometek@ms15.hinet.net

**ELECTROMAGNETIC COMPATIBILITY  
AND TELECOMMUNICATIONS**

**NVLAP LAB CODE 200331-0**

*NVLAP Code Designation / Description*

**Emissions Test Methods:**

12/CIS14a	EN 55014-1 (1993), A1 (1997), A2 (1999):
12/CIS14a2	BS EN 55014-1 (2001) with A1 and A2: Electromagnetic compatibility - Requirements for household appliances, electric tools and similar apparatus - Part 1: Emission
12/CIS14b1	AS/NZS CISPR 14-1 (2003): Electromagnetic Compatibility - Requirements for household appliances, electric tools and similar apparatus - Part 1: Emission
12/CIS14c	CNS 13783-1: Electromagnetic Compatibility Requirements for household appliances, electric tools and similar apparatus - Part 1: Emissions
12/CIS14d	IEC/CISPR 14-1 (2001) and A1 (2001): Electromagnetic Compatibility - Requirements for household appliances, electric tools and similar apparatus - Part 1: Emissions
12/CIS14x	IEC/CISPR 14-1, Ed. 4 (2003): Electromagnetic Compatibility - Requirements for household appliances, electric tools and similar apparatus - Part 1: Emission
12/CIS22	IEC/CISPR 22 (1997) & EN 55022 (1998) + A1(2000): Limits and methods of measurement of radio disturbance characteristics of information technology equipment

2006-10-01 through 2007-09-30

*Effective dates*

*Sally S. Bruce*  
For the National Institute of Standards and Technology



**National Voluntary  
Laboratory Accreditation Program**



**ELECTROMAGNETIC COMPATIBILITY  
AND TELECOMMUNICATIONS**

**NVLAP LAB CODE 200331-0**

<i>NVLAP Code</i>	<i>Designation / Description</i>
12/CIS22a	IEC/CISPR 22 (1993) and EN 55022 (1994): Limits and methods of measurement of radio disturbance characteristics of information technology equipment, Amendment 1 (1995) and Amendment 2 (1996)
12/CIS22b	CNS 13438 (1997): Limits and Methods of Measurement of Radio Interference Characteristics of Information Technology Equipment
12/CIS22c	IEC/CISPR 22, Fourth Edition (2003-04) & EN 55022 (1998): Information technology equipment - Radio disturbance characteristics - Limits and methods of measurement
12/FCC15b	ANSI C63.4 (2003) with FCC Method 47 CFR Part 15, Subpart B: Unintentional Radiators
12/T51a	AS/NZS CISPR 22 (2004): Information technology equipment - Radio disturbance characteristics - Limits and methods of measurement
12/VCCIa	VCCI: Agreement of Voluntary Control Council for Interference by Information Technology Equipment - Technical Requirements: V-3/2005.04

2006-10-01 through 2007-09-30

*Effective dates*

*For the National Institute of Standards and Technology*