



EMC TEST REPORT

According to

EN 55022:2006/A1:2007 (Class B)
EN 61000-3-2 : 2009
EN 61000-3-3 : 2008

EN 55024 : 1998/ A1:2001/ A2:2003
IEC 61000-4-2 : 2008
IEC 61000-4-3 : 2010
IEC 61000-4-4 : 2010
IEC 61000-4-5 : 2005
IEC 61000-4-6 : 2008
IEC 61000-4-8 : 2009
IEC 61000-4-11 : 2004

Applicant : SMART CABLING & TRANSMISSION CORP.
Address : 10F, No. 493, Chung-Cheng Rd., Hsin Tien City,
Tapei 231, Taiwan, R.O.C.
Equipment : Twisted Pair Transmission Amplifier
Model No. : TPA0XXX (X=1~9)
Trade Name : SC&T

- The test result refers exclusively to the test presented test model / sample.
- Without written approval of *Cerpass Technology Corp.* the test report shall not be reproduced except in full.
- This test report is only applicable to European Community.



Contents

CERTIFICATE OF COMPLIANCE	4
1. Declaration of Conformity and the CE Mark	5
2. Test Configuration of Equipment under Test	6
2.1. Feature of Equipment under Test.....	6
2.2. Test Manner	6
2.3. Description of Support Unit	6
2.4. General Information of Test.....	7
2.5. Measurement Uncertainty	7
2.6. History of this test report	8
3. Test of Conducted Emission	9
3.1. Test Limit	9
3.2. Test Procedures	10
3.3. Typical Test Setup	10
3.4. Measurement Equipment.....	10
3.5. Test Result and Data.....	11
3.6. Test Photographs	13
4. Test of Radiated Emission	14
4.1. Test Limit.....	14
4.2. Test Procedures	15
4.3. Typical Test Setup	16
4.4. Measurement Equipment.....	16
4.5. Test Result and Data.....	17
4.6. Test Photographs	23
5. Harmonics Test	24
5.1. Limits of Harmonics Current Measurement	24
5.2. Measurement Equipment.....	24
5.3. Test Result and Data.....	24
6. Voltage Fluctuations Test	25
6.1. Test Procedure	25
6.2. Measurement Equipment.....	25
6.3. Test Result and Data.....	26
6.4. Test Photographs	27
7. Electrostatic Discharge Immunity Test	28
7.1. Test Procedure	28
7.2. Test Setup for Tests Performed in Laboratory.....	29
7.3. Test Severity Levels	30
7.4. Measurement Equipment.....	30
7.5. Test Result and Data.....	31
7.6. Test Photographs	32
8. Radio Frequency electromagnetic field immunity test	33
8.1. Test Procedure	33
8.2. Test Severity Levels	33
8.3. Measurement Equipment.....	33



8.4. Test Result and Data..... 34

8.5. Test Photographs 35

9. Electrical Fast Transient/ Burst Immunity Test..... 36

9.1. Test Procedure 36

9.2. Test Severity Levels 37

9.3. Measurement Equipment..... 37

9.4. Test Result and Data..... 38

9.5. Test Photographs 39

10. Surge Immunity Test..... 40

10.1. Test Procedure 40

10.2. Test Severity Level 41

10.3. Measurement Equipment..... 41

10.4. Test Result and Data..... 42

10.5. Test Photographs 43

11. Conduction Disturbances induced by Radio-Frequency Fields 44

11.1. Test Procedure 44

11.2. Test Severity Levels 45

11.3. Measurement Equipment..... 45

11.4. Test Result and Data..... 46

11.5. Test Photographs 47

12. Power Frequency Magnetic Field Immunity Test..... 48

12.1. Test Setup 48

12.2. Test Severity Levels 48

12.3. Measurement Equipment..... 48

12.4. Test Result and Data..... 49

12.5. Test Photographs 50

13. Voltage Dips and Voltage Interruptions Immunity Test Setup 51

13.1. Test Conditions..... 51

13.2. Measurement Equipment..... 51

13.3. Test Result and Data..... 52

13.4. Test Photographs 53

Appendix A. Photographs of EUT.....A1 ~ A8



CERTIFICATE OF COMPLIANCE

According to

EN 55022:2006/A1:2007 (Class B)
EN 61000-3-2 : 2009
EN 61000-3-3 : 2008

EN 55024 : 1998/ A1:2001/ A2:2003
IEC 61000-4-2 : 2008
IEC 61000-4-3 : 2010
IEC 61000-4-4 : 2010
IEC 61000-4-5 : 2005
IEC 61000-4-6 : 2008
IEC 61000-4-8 : 2009
IEC 61000-4-11 : 2004

Applicant : SMART CABLING & TRANSMISSION CORP.
Address : 10F, No. 493, Chung-Cheng Rd., Hsin Tien City,
Taipei 231, Taiwan, R.O.C.
Equipment : Twisted Pair Transmission Amplifier
Model No. : TPA0XXX (X=1~9)

I **HEREBY CERTIFY THAT :**

The measurements shown in this test report were made in accordance with the procedures given in **EUROPEAN COUNCIL DIRECTIVE 2004/108/EC.**

The equipment was **passed** the test performed according to **European Standard EN 55022:2006/A1:2007 (Class B), EN 61000-3-2: 2009, EN 61000-3-3:2008 and EN 55024:1998/ A1:2001/ A2:2003 (IEC 61000-4-2 : 2008, IEC 61000-4-3 : 2010, IEC 61000-4-4 : 2010, IEC 61000-4-5 : 2005, IEC 61000-4-6 : 2008, IEC 61000-4-8 : 2009, IEC 61000-4-11 : 2004).**

The test was carried out on Aug. 05, 2011 at **CerpPASS Technology Corp.**

Signature

Hill Chen

EMC/RF B.U. Chief of Engineering Dept.



1. Declaration of Conformity and the CE Mark

There are three possible procedures pertaining to the declaration of conformity:

1.1. Conformity Testing and Declaration of Conformity by the Manufacturer or His Authorized Representative Established within the Community or by an Importer.

- Article 10 (1) of the EMC Directive, - § 3 (1) no. 2a of the EMC Act.

1.2. Declaration of Conformity Issued by the Manufacturer or His Authorized Representative Established within the Community or by an Importer Following Testing of the Product and Issued of an EC certificate of conformity by a competent body.

- Article 10 (2) of the EMC Directive, - § 3 (1) no. 2b of the EMC Act.

1.3. Declaration of Conformity Issued by the Manufacturer or His Authorized Representative Established within the Community or by an Importer Following Testing and Certification of the Product by a Notified Body.

- Article 10 (5) of the EMC Directive,
- § 3 (1) no. 2b of the EMC Act (radio transmitting installations).

1.4. Specimen For The CE Marking Of Electrical / Electronical Equipment

The components of the CE marking shall have substantially the same vertical dimension, which may not be less than 5 mm.





2. Test Configuration of Equipment under Test

2.1. Feature of Equipment under Test

Please refer to the user manual.

2.2. Test Manner

- During testing, the interface cables and equipment positions were varied according to Europe Standard EN55022.
- The complete test system included CCTV, DVD Player, Video Ground Loop Isolator and EUT for EMC test.
- The EUT was executed to transmit and receive signals via DVD Player.

2.3. Description of Support Unit

Device	Manufacturer	Model No.	Description
DVD Player	SONY	DVP-NS718HP	Power Cable, Adapter Unshielding 1.8m
CCTV	TVS	CM-14VN	Power Cable, Adapter Unshielding 1.8m
Video Ground Loop Isolator	SC&T	TGP00X	Power Cable, Adapter Unshielding 1.8m

Use Cable:

Cable	Quantity	Description
Coaxial	15	Shielding, 1.5m
Coaxial	1	Shielding, 1.8m
Console	32	Unshielding, 0.8m



2.4. General Information of Test

Test Site :	Cerpass Technology Corp. 2F-11, No. 3, Yuan Qu St., (Nankang Software Park), Taipei, Taiwan 115, R.O.C.
Test Site Location (OATS2-SD) :	No.68-1, Shihbachongsi, Shihding Township, Taipei City 223, Taiwan, R.O.C.
FCC Registration Number :	TW1049, TW1061, 488071, 390316
IC Registration Number :	4934B-1, 4934D-1
VCCI Registration Number :	T-543 for Telecommunication Test C-3328 for Conducted emission test R-3013 for Radiated emission test G-97 for radiated disturbance above 1GHz
Test in Compliance with:	EMI Test (conduction and radiation) : EN 55022:2006/A1:2007 Class B Harmonics Test : EN 61000-3-2:2009 Voltage Fluctuations Test : EN 61000-3-3:2008 EMS Test : EN 55024 :1998/ A1:2001/ A2:2003 ESD : IEC 61000-4-2 : 2008 RS : IEC 61000-4-3 : 2010 EFT : IEC 61000-4-4 : 2010 SURGE : IEC 61000-4-5 : 2005 CS : IEC 61000-4-6 : 2008 Power Frequency Magnetic Field : IEC 61000-4-8 : 2009 DIPS : IEC 61000-4-11 : 2004
Test Voltage:	AC 230V/ 50Hz
Frequency Range Investigated :	Conducted Emission Test: from 150kHz to 30 MHz Radiated Emission Test: from 30 MHz to 6,000 MHz
Test Distance :	The test distance of radiated emission below 1GHz from antenna to EUT is 10 M. The test distance of radiated emission above 1GHz from antenna to EUT is 3 M.

2.5. Measurement Uncertainty

Measurement Item	Measurement Frequency	Polarization	Uncertainty
Conducted Emission	9 kHz ~ 30 MHz	LINE / NEUTRAL	2.71dB
Radiated Emission	30 MHz ~ 1,000 MHz	Vertical	3.52 dB
		Horizontal	3.39 dB
	1,000 MHz ~ 18,000 MHz	Vertical	4.39 dB
		Horizontal	5.25 dB



3. Test of Conducted Emission

3.1. Test Limit

Conducted Emissions were measured from 150 kHz to 30 MHz with a bandwidth of 9 kHz and return leads of the EUT according to the methods defined in European Standard EN 55022. The EUT was placed on a nonmetallic stand in a shielded room 0.8 meters above the ground plane as shown in section 4.2. The interface cables and equipment positioning were varied within limits of reasonable applications to determine the position producing maximum conducted emissions.

Table 1 Class B Line Conducted Emission Limits:

Frequency range (MHz)	Limits (dB μ V)	
	Quasi Peak	Average
0.15 to 0.50	66 to 56	56 to 46
0.50 to 5	56	46
5. to 30.	60	50

Note 1: The lower limits shall apply at the transition frequencies.
Note 2: The limit decreases linearly with the logarithm of the frequency in the range 0.15 MHz to .50MHz.

3.2. Test Procedures

- a. The EUT was placed on a desk 0.8 meters height from the metal ground plane and 0.4 meter from the conducting wall of the shielding room and it was kept at least 0.8 meters from any other grounded conducting surface.
- b. Connect EUT to the power mains through a line impedance stabilization network (LISN).
- c. All the support units are connecting to the other LISN.
- d. The LISN provides 50 ohm coupling impedance for the measuring instrument.
- e. The CISPR states that a 50 ohm, 50 micro-Henry LISN should be used.
- f. Both sides of AC line were checked for maximum conducted interference.
- g. The frequency range from 150 kHz to 30 MHz was searched
- h. Set the test-receiver system to Peak Detect Function and Specified Bandwidth with Maximum Hold Mode.

3.3. Typical Test Setup

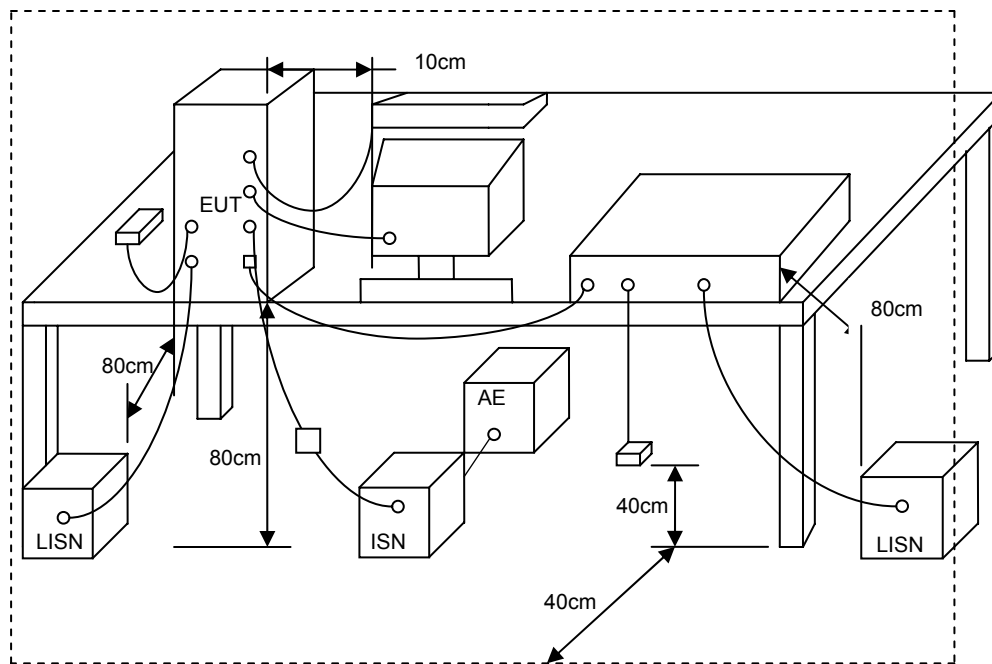

3.4. Measurement Equipment

Instrument	Manufacturer	Model No.	Serial No.	Calibration Date	Valid Date
EMI Receiver	R&S	ESCI	100443	2011/02/08	2012/02/07
LISN	Schwarzbeck	NSLK 8127	8127-516	2011/05/05	2012/05/04
LISN	Schwarzbeck	NSLK 8127	8127-568	2010/09/17	2011/09/16



3.5. Test Result and Data

Power	: AC 230V	Pol/Phase	: LINE
Test Mode	: Keep Working	Temperature	: 24 °C
Memo	:	Humidity	: 65 %

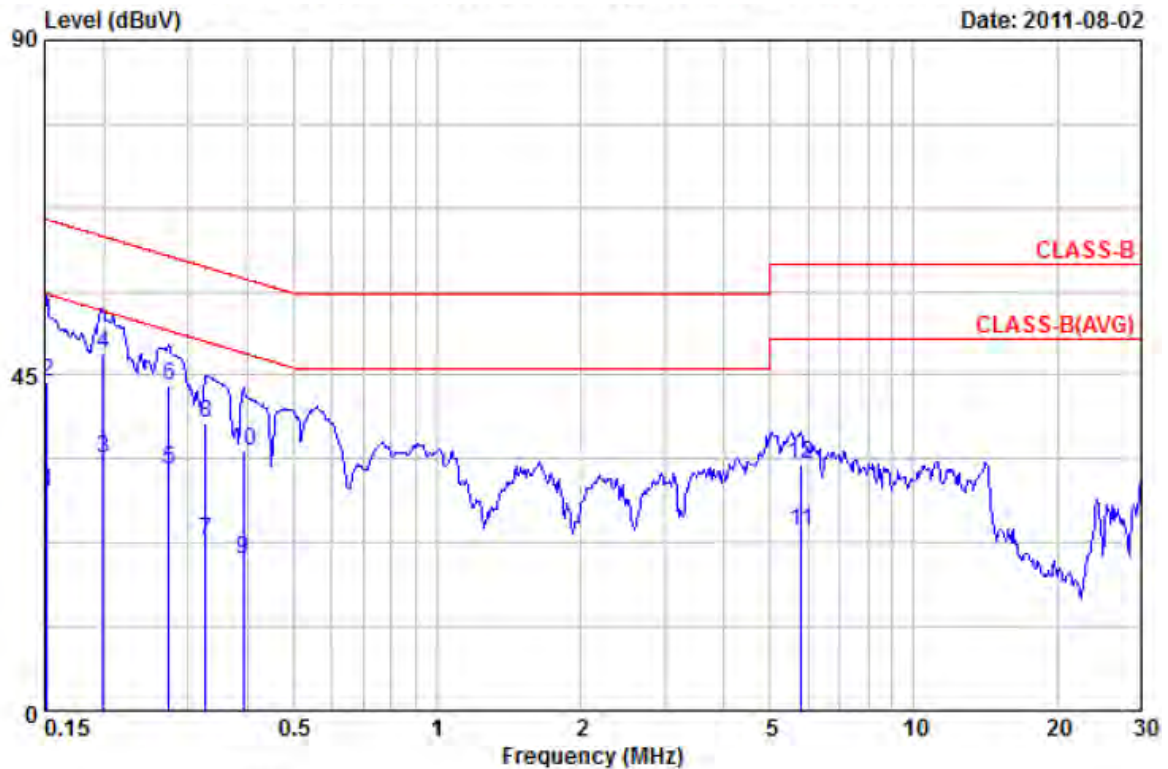

Item	Freq	Read Value	Factor	Result	Limit	Margin	Remark
	MHz	dBuV	dB	dBuV	dBuV	dBuV	
1	0.152	29.112	0.116	29.228	55.912	-26.684	Average
2	0.152	44.111	0.116	44.227	65.912	-21.685	QP
3	0.199	33.630	0.120	33.750	53.668	-19.918	Average
4	0.199	47.818	0.120	47.938	63.668	-15.730	QP
5	0.273	32.210	0.123	32.333	51.027	-18.694	Average
6	0.273	43.527	0.123	43.650	61.027	-17.377	QP
7	0.327	22.579	0.125	22.704	49.531	-26.827	Average
8	0.327	38.474	0.125	38.599	59.531	-20.932	QP
9	0.391	20.141	0.127	20.268	48.035	-27.767	Average
10	0.391	34.772	0.127	34.899	58.035	-23.136	QP
11	5.805	23.687	0.422	24.109	50.000	-25.891	Average
12	5.805	32.787	0.422	33.209	60.000	-26.791	QP

Remarks: 1. Result = Read Value + Factor
 2. Factor = LISN(ISN) Factor + Cable Loss



Power	: AC 230V	Pol/Phase	: NEUTRAL
Test Mode	: Keep Working	Temperature	: 24 °C
Memo	:	Humidity	: 65 %

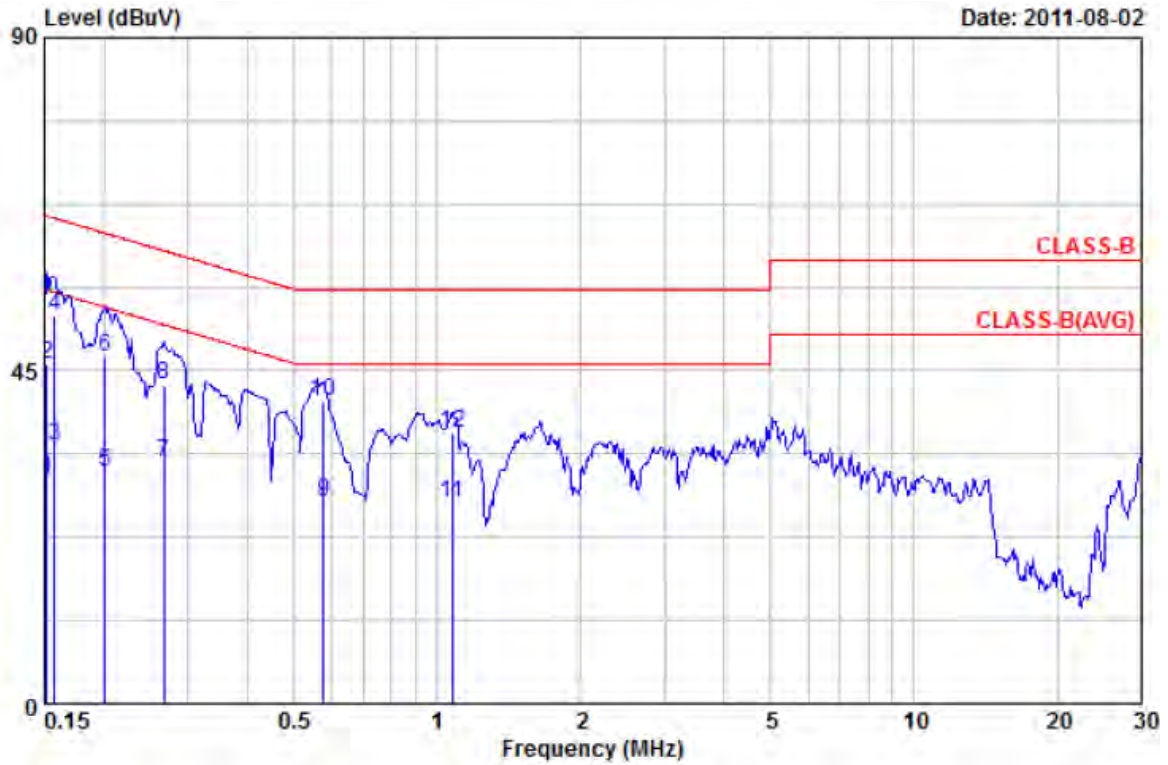

Item	Freq MHz	Read Value dBuV	Factor dB	Result dBuV	Limit dBuV	Margin dBuV	Remark
1	0.152	30.336	0.096	30.432	55.912	-25.480	Average
2	0.152	45.851	0.096	45.947	65.912	-19.965	QP
3	0.157	34.695	0.097	34.792	55.605	-20.813	Average
4	0.157	52.201	0.097	52.298	65.605	-13.307	QP
5	0.201	31.345	0.101	31.446	53.580	-22.134	Average
6	0.201	46.774	0.101	46.875	63.580	-16.705	QP
7	0.267	32.525	0.106	32.631	51.203	-18.572	Average
8	0.267	43.126	0.106	43.232	61.203	-17.971	QP
9	0.576	27.254	0.128	27.382	46.000	-18.618	Average
10	0.576	40.759	0.128	40.887	56.000	-15.113	QP
11	1.077	26.844	0.177	27.021	46.000	-18.979	Average
12	1.077	36.518	0.177	36.695	56.000	-19.305	QP

Remarks: 1. Result = Read Value + Factor
 2. Factor = LISN(ISN) Factor + Cable Loss

Test engineer: Dian



3.6. Test Photographs

Front View



Rear View





4. Test of Radiated Emission

4.1. Test Limit

The EUT shall meet the limits of below Table when measured at the measuring distance R in accordance with the methods described in European Standard EN 55022 Clause 10. If the reading on the measuring receiver shows fluctuations close to the limit, the reading shall be observed for at least 15 s at each measurement frequency; the highest reading shall be recorded, with the exception of any brief isolated high reading, which shall be ignored.

Table – Limits for radiated disturbance of class B ITE at a measuring distance of 10 m

Frequency range MHz	Quasi-peak limits dB(μ V/m)
30 to 230	30
230 to 1000	37

NOTE 1 The lower limit shall apply at the transition frequency.
NOTE 2 Additional provisions may be required for cases where interference occurs.

The EUT shall meet the limits of below Table when measured in accordance with the method described in European Standard EN 55022 Clause 10 and the conditional testing procedure described below.

Table – Limits for radiated disturbance of class B ITE at a measuring distance of 3 m

Frequency range GHz	Average limit dB(μ V/m)	Peak limits dB(μ V/m)
1 to 3	50	70
3 to 6	54	74

NOTE The lower limit applies at the transition frequency.

• Conditional testing procedure:

The highest internal source of an EUT is defined as the highest frequency generated or used within the EUT or on which the EUT operates or tunes.

If the highest frequency of the internal sources of the EUT is less than 108 MHz, the measurement shall only be made up to 1 GHz.

If the highest frequency of the internal sources of the EUT is between 108 MHz and 500 MHz, the measurement shall only be made up to 2 GHz.

If the highest frequency of the internal sources of the EUT is between 500 MHz and 1 GHz, the measurement shall only be made up to 5 GHz.

If the highest frequency of the internal sources of the EUT is above 1 GHz, the measurement shall be made up to 5 times the highest frequency or 6 GHz, whichever is less.



4.2. Test Procedures

- a. The EUT was placed on a rotatable table top 0.8 meter above ground.
- b. The EUT was set 3/10 meters from the interference receiving antenna which was mounted on the top of a variable height antenna tower.
- c. The table was rotated 360 degrees to determine the position of the highest radiation.
- d. The antenna is a half wave dipole and its height is varied between one meter and four meters above ground to find the maximum value of the field strength both horizontal polarization and vertical polarization of the antenna are set to make the measurement.
- e. For each suspected emission the EUT was arranged to its worst case and then tune the antenna tower (from 1 M to 4 M) and turn table (from 0 degree to 360 degrees) to find the maximum reading.
- f. Set the test-receiver system to Peak Detect Function and specified bandwidth with Maximum Hold Mode.
- g. If the emission level of the EUT in peak mode was 3 dB lower than the limit specified, then testing will be stopped and peak values of EUT will be reported, otherwise, the emissions which do not have 3 dB margin will be repeated one by one using the quasi-peak method and reported.

4.3. Typical Test Setup

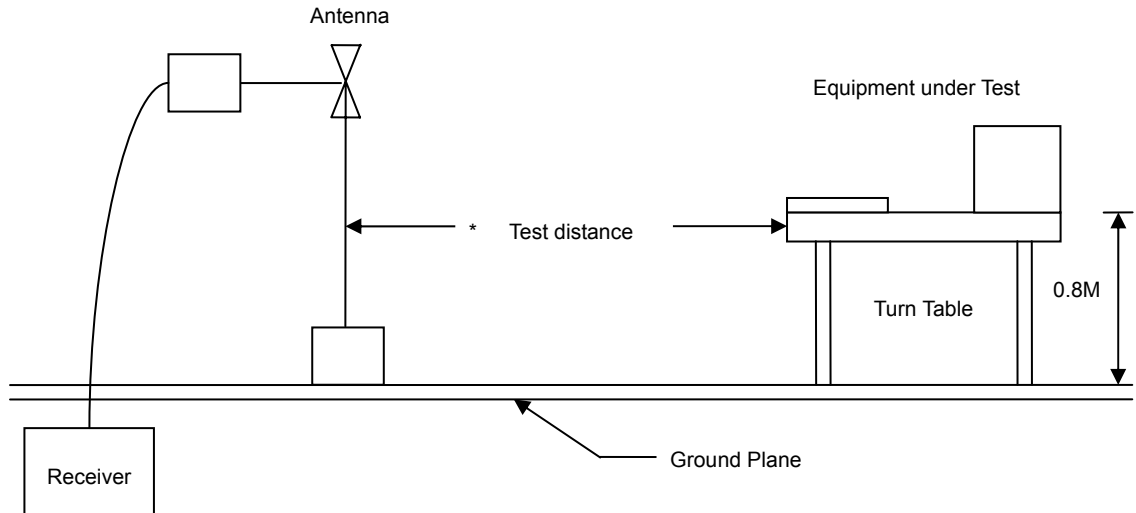

4.4. Measurement Equipment

Instrument	Manufacturer	Model No.	Serial No.	Calibration Date	Valid Date
Amplifier	Agilent	8447D	2944A10531	2011/01/21	2012/01/20
Bilog Antenna	Schaffner	CBL6112D	22242	2011/02/09	2012/02/08
EMI Receiver	HP	8546A	3807A00454	2010/09/27	2011/09/26
RF Filter Section	HP	85460A	3704A00386	2010/09/27	2011/09/26
SPECTRUM ANALYZER	R&S	FSP40	100219	2010/11/05	2011/11/04
HORN ANTENNA	EMCO	3115	31589	2011/05/02	2012/05/01
Preamplifier	Agilent	8449B	3008A01954	2011/03/02	2012/03/01



4.5. Test Result and Data

Power	: AC 230V	Pol/Phase	: VERTICAL
Test Mode	: Keep Working	Temperature	: 26 °C
Memo	:	Humidity	: 67 %

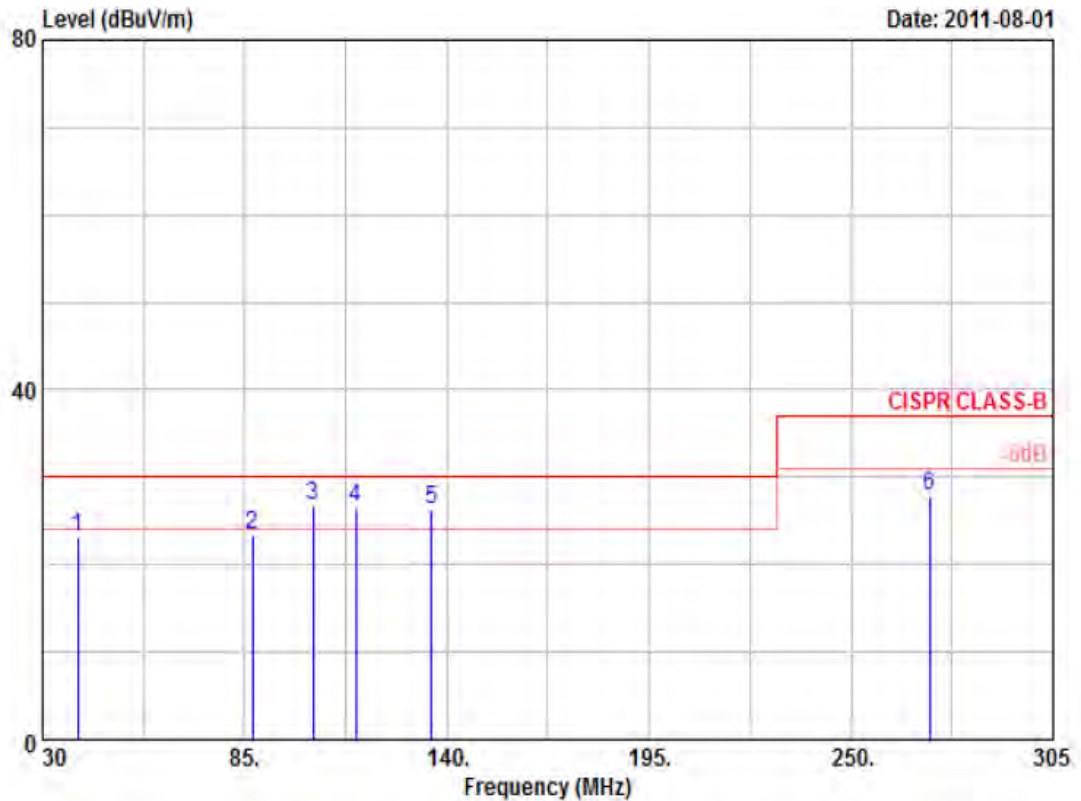

Item	Freq MHz	Read Value dBuV/m	Factor dB	Result dBuV/m	Limit dBuV/m	Margin dB	Remark	Ant Pos cm	Tab Pos Deg
1	39.63	41.13	-17.94	23.19	30.00	-6.81	QP	400	0
2	87.20	43.37	-19.92	23.45	30.00	-6.55	QP	400	0
3	103.70	44.07	-17.25	26.82	30.00	-3.18	QP	400	0
4	115.25	41.29	-14.74	26.55	30.00	-3.45	QP	400	0
5	135.88	42.44	-16.05	26.39	30.00	-3.61	QP	400	0
6	271.45	44.10	-16.20	27.90	37.00	-9.10	QP	400	0

Remarks: 1. Result = Read Value + Factor
 2. Factor = Antenna factor + Cable loss - Amplifier factor



Power	: AC 230V	Pol/Phase	: VERTICAL
Test Mode	: Keep Working	Temperature	: 26 °C
Memo	:	Humidity	: 67 %

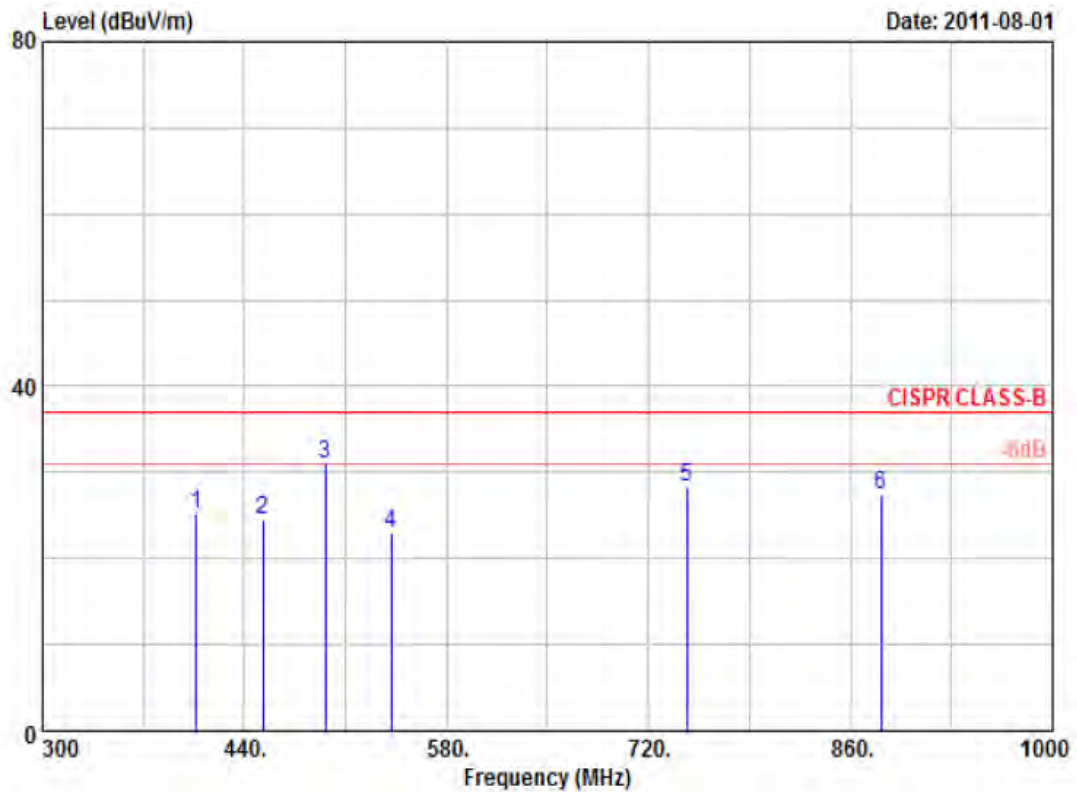

Item	Freq MHz	Read Value dBuV/m	Factor dB	Result dBuV/m	Limit dBuV/m	Margin dB	Remark	Ant Pos cm	Tab Pos Deg
1	406.40	39.68	-14.44	25.24	37.00	-11.76	QP	100	0
2	452.60	37.21	-12.66	24.55	37.00	-12.45	QP	100	0
3	496.00	38.82	-7.75	31.07	37.00	-5.93	QP	100	0
4	541.50	32.45	-9.51	22.94	37.00	-14.06	QP	100	0
5	746.60	26.71	1.65	28.36	37.00	-8.64	QP	100	0
6	881.00	26.80	0.53	27.33	37.00	-9.67	QP	100	0

Remarks: 1. Result = Read Value + Factor
 2. Factor = Antenna factor + Cable loss - Amplifier factor



Power	: AC 230V	Pol/Phase	: HORIZONTAL
Test Mode	: Keep Working	Temperature	: 26 °C
Memo	:	Humidity	: 67 %

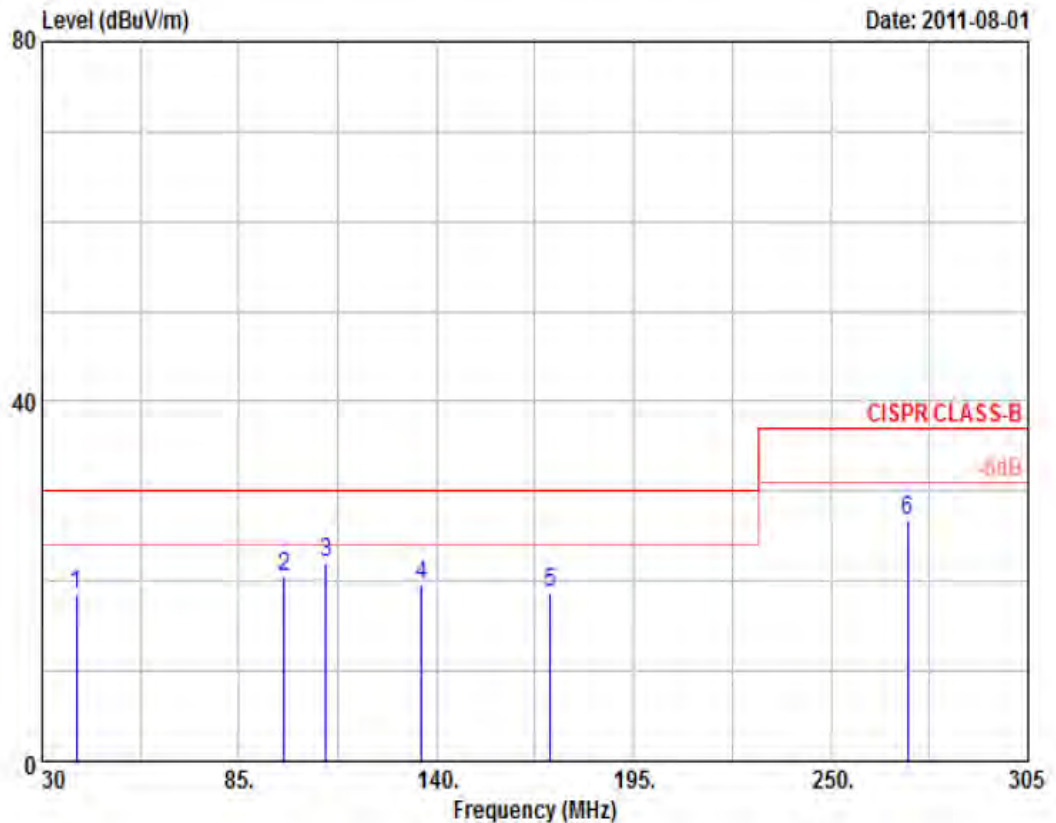

Item	Freq MHz	Read Value dBuV/m	Factor dB	Result dBuV/m	Limit dBuV/m	Margin dB	Remark	Ant Pos cm	Tab Pos Deg
1	39.63	34.97	-16.58	18.39	30.00	-11.61	QP	400	0
2	97.65	44.08	-23.66	20.42	30.00	-9.58	QP	400	0
3	109.20	45.27	-23.30	21.97	30.00	-8.03	QP	400	0
4	135.88	40.85	-21.32	19.53	30.00	-10.47	QP	400	0
5	171.63	39.19	-20.54	18.65	30.00	-11.35	QP	400	0
6	271.45	42.30	-15.64	26.66	37.00	-10.34	QP	400	0

Remarks: 1. Result = Read Value + Factor
 2. Factor = Antenna factor + Cable loss - Amplifier factor



Power	: AC 230V	Pol/Phase	: HORIZONTAL
Test Mode	: Keep Working	Temperature	: 26 °C
Memo	:	Humidity	: 67 %

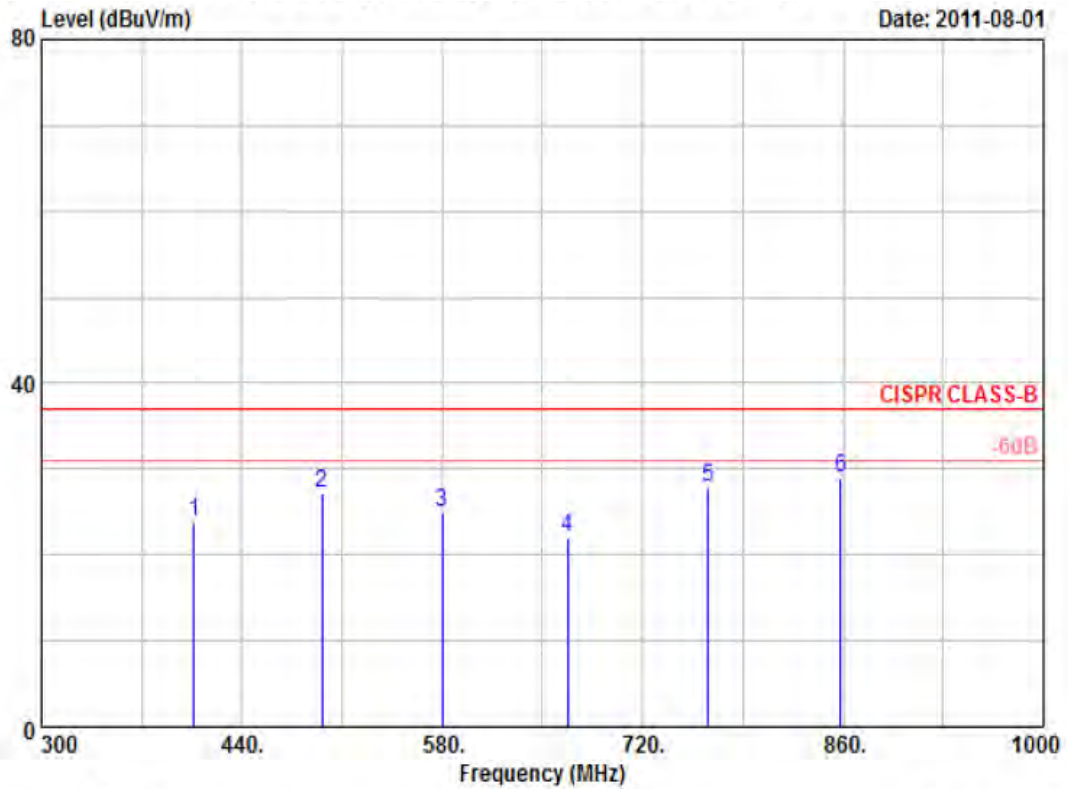

Item	Freq MHz	Read Value dBuV/m	Factor dB	Result dBuV/m	Limit dBuV/m	Margin dB	Remark	Ant Pos cm	Tab Pos Deg
1	406.40	33.30	-9.40	23.90	37.00	-13.10	QP	100	0
2	496.00	30.72	-3.50	27.22	37.00	-9.78	QP	100	0
3	580.00	27.05	-2.06	24.99	37.00	-12.01	QP	100	0
4	667.50	25.93	-3.86	22.07	37.00	-14.93	QP	100	0
5	765.50	26.07	1.84	27.91	37.00	-9.09	QP	100	0
6	858.60	25.57	3.38	28.95	37.00	-8.05	QP	100	0

Remarks: 1. Result = Read Value + Factor
 2. Factor = Antenna factor + Cable loss - Amplifier factor



Power	: AC 230V	Pol/Phase	: VERTICAL
Test Mode	: Keep Working	Temperature	: 26 °C
Memo	:	Humidity	: 67 %

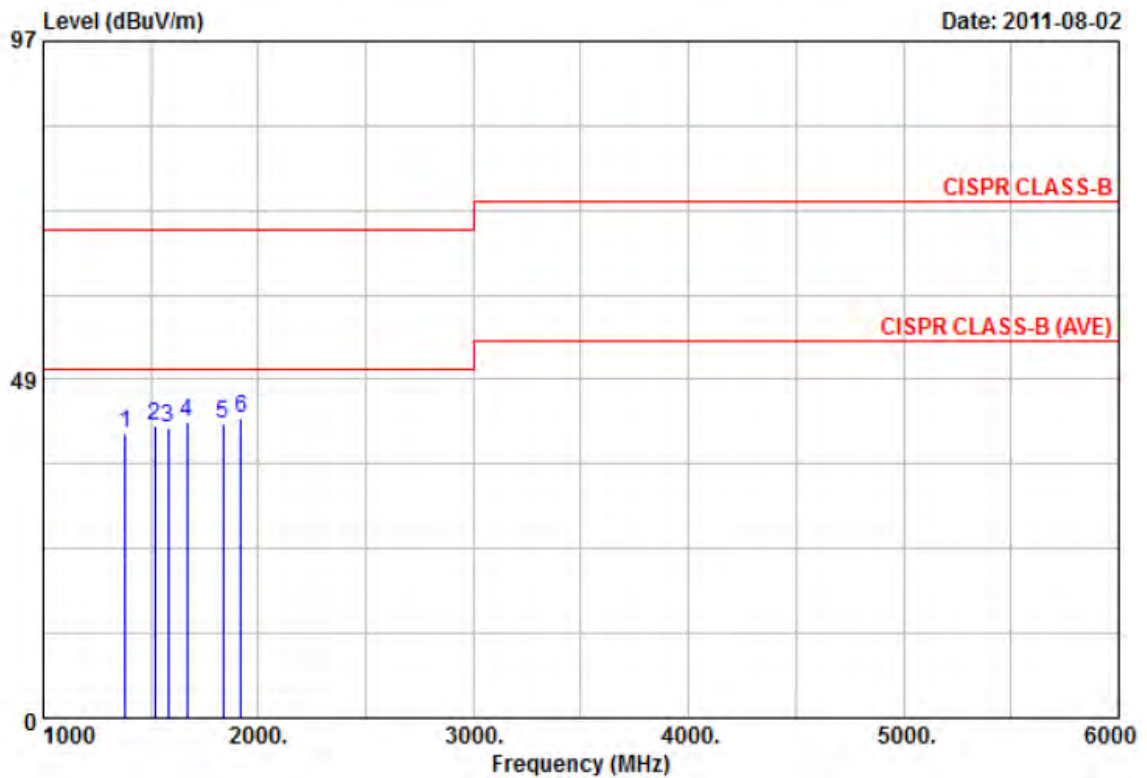

Item	Freq	Read Value	Factor	Result	Limit	Margin	Remark	Ant Pos	Tab Pos
	MHz	dBuV	dB/m	dBuV/m	dBuV/m	dB		cm	Deg
1	1380.00	47.88	-7.13	40.75	70.00	-29.25	Peak	100	360
2	1520.00	48.07	-6.30	41.77	70.00	-28.23	Peak	100	360
3	1580.00	47.53	-5.93	41.60	70.00	-28.40	Peak	100	360
4	1670.00	47.75	-5.36	42.39	70.00	-27.61	Peak	100	360
5	1835.00	46.47	-4.34	42.13	70.00	-27.87	Peak	100	360
6	1920.00	46.65	-3.80	42.85	70.00	-27.15	Peak	100	360

Remarks: 1. Result = Read Value + Factor
 2. Factor = Antenna factor + Cable loss - Amplifier factor



Power	: AC 230V	Pol/Phase	: HORIZONTAL
Test Mode	: Keep Working	Temperature	: 26 °C
Memo	:	Humidity	: 67 %

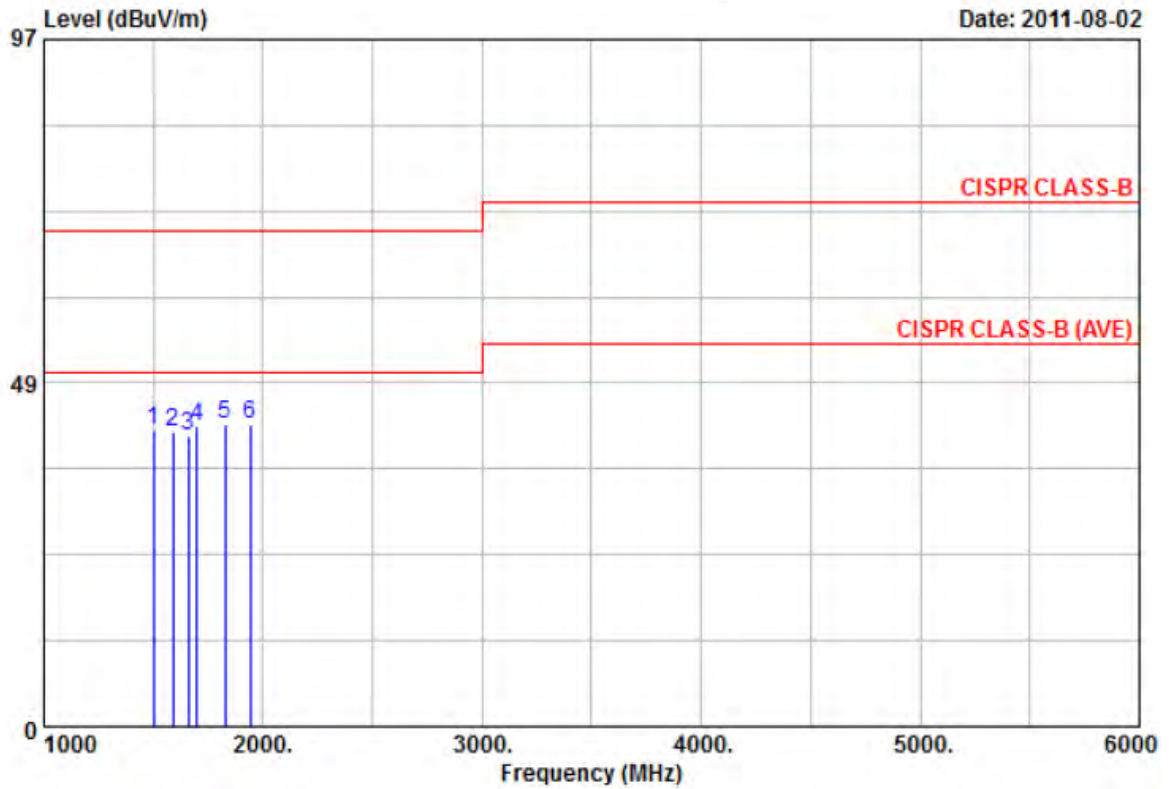

Item	Freq	Read Value	Factor	Result	Limit	Margin	Remark	Ant Pos	Tab Pos
	MHz	dBuV	dB/m	dBuV/m	dBuV/m	dB		cm	Deg
1	1500.00	48.35	-6.43	41.92	70.00	-28.08	Peak	100	0
2	1590.00	47.36	-5.87	41.49	70.00	-28.51	Peak	100	0
3	1660.00	46.50	-5.43	41.07	70.00	-28.93	Peak	100	0
4	1700.00	47.47	-5.18	42.29	70.00	-27.71	Peak	100	0
5	1825.00	47.12	-4.41	42.71	70.00	-27.29	Peak	100	0
6	1940.00	46.27	-3.68	42.59	70.00	-27.41	Peak	100	0

Remarks: 1. Result = Read Value + Factor
 2. Factor = Antenna factor + Cable loss - Amplifier factor

Test engineer: Ray



4.6. Test Photographs

Front View



Rear View





5. Harmonics Test

5.1. Limits of Harmonics Current Measurement

Limits for Class A equipment		Limits for Class D equipment		
Harmonics Order n	Max. Permissible harmonics current A	Harmonics Order n	Max. Permissible harmonics current per watt mA/W	Max. Permissible harmonics current A
Odd harmonics		Odd Harmonics only		
3	2.30	3	3.4	2.30
5	1.14	5	1.9	1.14
7	0.77	7	1.0	0.77
9	0.40	9	0.5	0.40
11	0.33	11	0.35	0.33
13	0.21	13	0.30	0.21
15<=n<=39	0.15 x 15/n	15<=n<=39	3.85/n	0.15 x 15/n
Even harmonics				
2	1.08			
4	0.43			
6	0.30			
8<=n<=40	0.23 x 8/n			

NOTE:

1. Class A and Class D are classified according to item section 5 of EN 61000-3-2: 2009.
2. According go section 7 of EN 61000-3-2: 2009, the above limits for all equipment except for lighting equipment are for all applications having a rated power > 75 W and no limits apply for equipment with an active input power up to and including 75 W.

5.2. Measurement Equipment

Instrument	Manufacturer	Model No.	Serial No.	Calibration Date	Valid Date
Power & Harmonics Analyzer	TTI	HA1600	198226	2010/12/28	2011/12/27

5.3. Test Result and Data

As specified on clause 7 and figure Z1 of EN 61000-3-2:2009, the limits are not specified for equipment with a rated power of 75W or less.

The EUT meets the above condition, so it conforms to EN 61000-3-2



6. Voltage Fluctuations Test

6.1. Test Procedure

The equipment shall be tested under the conditions of **Clause 5**.

The total impedance of the test circuit, excluding the appliance under test, but including the internal impedance of the supply source, shall be equal to the reference impedance. The stability and tolerance of the reference impedance shall be adequate to ensure that the overall accuracy of $\pm 8\%$ is achieved during the whole assessment procedure.

6.2. Measurement Equipment

Instrument	Manufacturer	Model No.	Serial No.	Calibration Date	Valid Date
Power & Harmonics Analyzer	TTI	HA1600	198226	2010/12/28	2011/12/27



6.3. Test Result and Data

Final Test Result : **PASS**

Basic Standard : EN 61000-3-3

Temperature : 27

Test Data : Aug. 05, 2011

Relative Humidity : 54 %

Supply Voltage: 230.4 to 230.4 Vrms 328.0 Vpk Frequency: 50.03 Hz
THD: 0.6% Crest Factor: 1.424 peak at: 92.3 deg

Load Power: 0.006 kW 0.016 kVA Power Factor: 0.409

Load Current: 0.07 to 0.07 Arms 0.29 Apk Crest Factor: 4.189

Voltage Variations

Highest Half-cycle level: +0.24%

Lowest Half-cycle level: +0.12%

d(max): 0.12%

Pass

Number of Change Intervals: 1

Highest d(t) for 500 ms: 0.00%

Longest d(t) over 3.30%: 0.00 seconds

Pass

'Steady State' definition: >1000 ms below 0.32%

Highest Steady State level: 0.17%

Lowest Steady State level: 0.17%

max d(c) between adjacent: 0.00%

max d(c) between any: 0.00%

Pass

Flicker

Long-term Flicker indicator Plt : 0.00

Short-term Flicker indicator Pst :

Plt Interval

Pst

1: 0.06

2: 0.06

3: 0.06

4: 0.06

5: 0.06

6: 0.06

7: 0.06

8: 0.06

9: 0.06

10: 0.06

11: 0.06

12: 0.06

Pst classifier: Duration Flicker

0.1% 0.01

0.7% 0.01

1.0% 0.01

1.5% 0.01

2.2% 0.01

3% 0.01

4% 0.01

6% 0.01

8% 0.01

10% 0.01

13% 0.01

17% 0.01

30% 0.00

50% 0.00

80% 0.00

Test engineer: Dora



6.4. Test Photographs

Front View



Rear View





7. Electrostatic Discharge Immunity Test

7.1. Test Procedure

- a. In the case of air discharge testing the climatic conditions shall be within the following ranges:
 - ambient temperature: 15 to 35 ;
 - relative humidity : 30% to 60%;
 - atmospheric pressure : 86 KPa (860 mbar) to 106 KPa (1060 mbar).
- b. Test programs and software shall be chosen so as to exercise all normal modes of operation of the EUT. The use of special exercising software is encouraged, but permitted only where it can be shown that the EUT is being comprehensively exercised.
- c. The test voltage shall be increased from the minimum to the selected test severity level, in order to determine any threshold of failure. The final severity level should not exceed the product specification value in order to avoid damage to the equipment.
- d. The test shall be performed with both air discharge and contact discharge. On reselected points at least 10 single discharges (in the most sensitive polarity) shall be applied on air discharge. On reselected points at least 25 single discharges (in the most sensitive polarity) shall be applied on contact discharge.
- e. For the time interval between successive single discharges an initial value of one second is recommended. Longer intervals may be necessary to determine whether a system failure has occurred.
- f. In the case of contact discharges, the tip of the discharge electrode shall touch the EUT before the discharge switch is operated.
- g. In the case of painted surface covering a conducting substrate, the following procedure shall be adopted :
 - If the coating is not declared to be an insulating coating by the equipment manufacturer, then the pointed tip of the generator shall penetrate the coating so as to make contact with the conducting substrate.
 - Coating declared as insulating by the manufacturer shall only be submitted to the air discharge.
 - The contact discharge test shall not be applied to such surfaces.
- h. In the case of air discharges, the round discharge tip of the discharge electrode shall be approached as fast as possible (without causing mechanical damage) to touch the EUT . After each discharge, the ESD generator (discharge electrode) shall be removed from the EUT. The generator is then retriggered for a new single discharge. This procedure shall be repeated until the discharges are completed. In the case of an air discharge test, the discharge switch, which is used for contact discharge, shall be closed.

7.2. Test Setup for Tests Performed in Laboratory

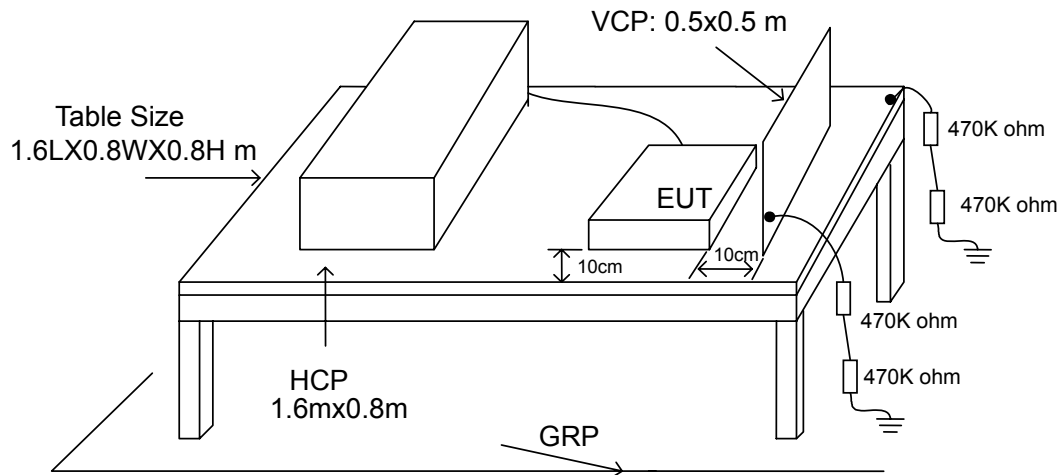

The test setup consists of the test generator, EUT and auxiliary instrumentation necessary to perform DIRECT and INDIRECT application of discharges to the EUT as applicable, in the following manner :

- a. Contact Discharge to the conductive surfaces and to coupling plane;
- b. Air Discharge at insulating surfaces.

The preferred test method is that of type tests performed in laboratories and the only accepted method of demonstrating conformance with this standard. The EUT was arranged as closely as possible to arrangement in final installed conditions.

A ground reference plane was provided on the floor of the test site. It was a metallic sheet (copper or aluminum) of 0.25 mm, minimum thickness; other metallic may be used but they shall have at least 0.65 mm thickness. In the CerpPASS Technology Corp., we provided 1 mm thickness stainless steel ground reference plane. The minimum size of the ground reference plane is 2.5 m x 2.5 m, the exact size depending on the dimensions of the EUT. It was connected to the protective grounding system.

The EUT was arranged and connected according to its functional requirements. A distance of 1m minimum was provided between the EUT and the wall of the lab. and any other metallic structure. In cases where this length exceeds the length necessary to apply the discharges to the selected points, the excess length shall, where possible, be placed non-inductively off the ground reference plane and shall not come closer than 0.2m to other conductive parts in the test setup.

Where the EUT is installed on a metal table, the table was connected to the reference plane via a cable with a 470k ohm resistor located at each end, to prevent a build-up of charge. The test setup was consist a wooden table, 0.8m high, standing on the ground reference plane. A HCP, 1.6 m x 0.8 m, was placed on the table. The EUT and cables was isolated from the HCP by an insulating support 0.5 mm thick. The VCP size, 0.5 m x 0.5 m.



7.3. Test Severity Levels

Contact Discharge		Air Discharge	
Level	Test Voltage (KV) of Contact discharge	Level	Test Voltage (KV) of Air Discharge
1	±2	1	±2
2	±4	2	±4
3	±6	3	±8
4	±8	4	±15
X	Specified	X	Specified

Remark: "X" is an open level.

7.4. Measurement Equipment

Instrument	Manufacturer	Model No.	Serial No.	Calibration Date	Valid Date
ESD SIMULATOR	Schaffner	NSG438	878	2011/06/16	2012/06/15



7.5. Test Result and Data

Final Test Result : **PASS**
 Pass performance criteria : A
 Required performance criteria : B
 Basic Standard : IEC 61000-4-2
 Product Standard : EN 55024
 Test Voltage : ±2 / ±4 / ±8 KV for air discharge,
 : ±2 / ±4 KV for contact discharge
 Temperature : 24°C
 Relative Humidity : 52 %
 Atmospheric Pressure : 1011 hPa
 Test Date : Aug. 05, 2011

	Contact Discharge				Air Discharge					
	25 times / each				10 times / each					
Voltage	2 KV		4 KV		2 KV		4 KV		8 KV	
Point\Polarity	+	-	+	-	+	-	+	-	+	-
HCP	A	A	A	A	---	---	---	---	---	---
VCP	A	A	A	A	---	---	---	---	---	---
Case	A	A	A	A	---	---	---	---	---	---
Screw	A	A	A	A	---	---	---	---	---	---
Coaxial	A	A	A	A	---	---	---	---	---	---
Switch	---	---	---	---	A	A	A	A	A	A

Note: "A" means the EUT function is normal working during the test.

Test engineer: Dora



7.6. Test Photographs

Front View



Rear View





8. Radio Frequency electromagnetic field immunity test

8.1. Test Procedure

- a. The equipment to be tested is placed in the center of the enclosure on a wooden table. The equipment is then connected to power and signal leads according to pertinent installation instructions.
- b. The antenna which is enabling the complete frequency range of 80-1000 MHz is placed 3m away from the equipment. The required field strength is determined by placing the field strength meter(s) on top of or directly alongside the equipment under test and monitoring the field strength meter via a remote field strength indicator outside the enclosure while adjusting the continuous-wave to the applicable antennae.
- c. The test is normally performed with the antenna facing the most sensitive side of the EUT. The polarization of the field generated by the bucolical antenna necessitates testing each position twice, once with the antenna positioned vertically and again with the antenna positioned horizontally. The circular polarization of the field from the log-spiral antenna makes a change of position of the antenna unnecessary.
- d. At each of the above conditions, the frequency range is swept 80-1000 MHz, pausing to adjust the R.F. signal level or to switch oscillators and antenna. The rate of sweep is in the order of 1.5×10^{-3} decades/s. The sensitive frequencies or frequencies of dominant interest may be discretely analyzed.

8.2. Test Severity Levels

Frequency Band : 80-1000 MHz	
Level	Test field strength (V/m)
1	1
2	3
3	10
X	Specified
Remark: "X" is an open class.	

8.3. Measurement Equipment

Instrument	Manufacturer	Model No.	Serial No.	Calibration Date	Valid Date
Amplifiers 80-1000MHz/100W	SCHAFFNER	CBA9413B	43510	N/A	N/A
Amplifiers 80-3000MHz/20W	SCHAFFNER	CBA9428	43515	N/A	N/A
Antenna	SCHAFFNER	CBL6141A	4257	N/A	N/A
Power Meter	Boonton	4231A-01	115902	2010/11/30	2011/11/29
Field Probe	HOLADAY	HI-6005	00035824	2011/05/19	2012/05/18
Signal Generator	HP	8648C	3836U02289	2010/11/12	2011/11/11
Power Sensor	Boonton	51011-EMC	33312	2010/11/30	2011/11/29



8.4. Test Result and Data

Final Test Result : **PASS**
 Pass performance criteria : A
 Required performance criteria : A
 Basic Standard : IEC 61000-4-3
 Product Standard : EN 55024
 Frequency Range : 80~1000 MHz
 Temperature : 25°C
 Relative Humidity : 51 %
 Atmospheric Pressure : 1011 hPa
 Test Date : Aug. 05, 2011

Modulation : AM 80% , 1KHz sine wave, Dwell time: 2.9 S				
Frequency Step Size : 1 % of preceding frequency value				
Frequency (MHz)	Antenna Polarization	face	Field strength (V/m)	Result
80~1000	Vertical	Front	3 V/m	A
80~1000	Vertical	Rear	3 V/m	A
80~1000	Vertical	Left	3 V/m	A
80~1000	Vertical	Right	3 V/m	A
80~1000	Horizontal	Front	3 V/m	A
80~1000	Horizontal	Rear	3 V/m	A
80~1000	Horizontal	Left	3 V/m	A
80~1000	Horizontal	Right	3 V/m	A

Note: "A" means the EUT function is normal working during the test.

Test engineer: Dora



8.5. Test Photographs

Front View



Rear View

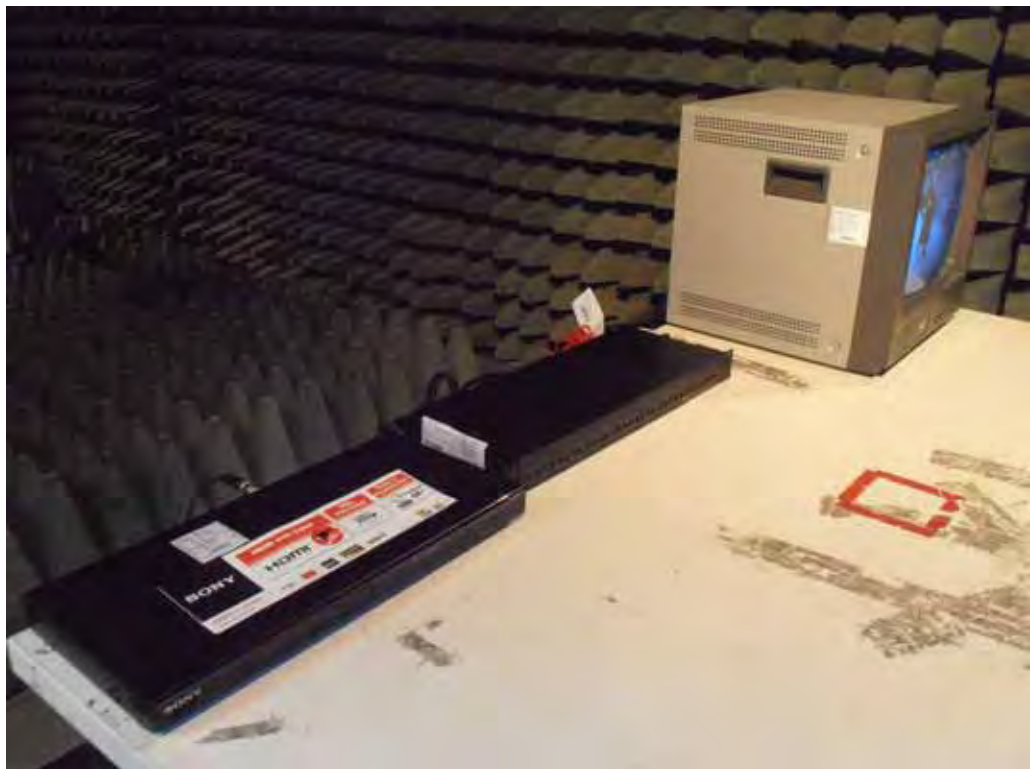



9. Electrical Fast Transient/ Burst Immunity Test

9.1. Test Procedure

- a. In order to minimize the effect of environmental parameters on test results, the climatic conditions when test is carrying out shall comply with the following requirements:
 - ambient temperature: 15 to 35 ;
 - relative humidity : 45% to 75%;
 - Atmospheric pressure: 86 Kpa (860 mbar) to 106 Kpa (1060 mbar).
- b. In order to minimize the effect of environmental parameters on test results, the electromagnetic environment of the laboratory shall not influence the test results.
- c. The variety and diversity of equipment and systems to be tested make it difficult to establish general criteria for the evaluation of the effects of fast transients/bursts on equipment and systems.
- d. Test on Power Line:
 - The EFT/B-generator was located on the GRP.. The length from the EFT/B-generator to the EUT is not exceeding 1 m.
 - The EFT/B-generator provides the ability to apply the test voltage in a non-symmetrical condition to the power supply input terminals of the EUT.
- e. Test on Communication Lines
 - The coupling clamp is composed of a clamp unit for housing the cable (length more than 3 m), and was placed on the GRP.
 - The coupling clamp provides the ability of coupling the fast transient/bursts to the cable under test.
- f. The test results may be classified on the basic of the operating conditions and the functional specification of the equipment under test, according to the following performance criteria :
 - Normal performance within the specification limits.
 - Temporary degradation or loss of function or performance which is self-recoverable.
 - Temporary degradation or loss of function or performance which requires operator intervention or system reset.
 - Degradation or loss of function which is not recoverable due to damage of equipment (components).



9.2. Test Severity Levels

The following test severity levels are recommended for the fast transient/burst test :

Open circuit output test voltage $\pm 10\%$		
Level	On Power Supply	On I/O signal, data and control line
1	0.5 KV	0.25 KV
2	1.0 KV	0.50 KV
3	2.0 KV	1.00 KV
4	4.0 KV	2.00 KV
X	Specified	Specified

Remark : " X " is an open level. The level is subject to negotiation between the user and manufacturer or is specified by the manufacturer.

9.3. Measurement Equipment

Instrument	Manufacturer	Model No.	Serial No.	Calibration Date	Valid Date
EMC Pro	KeyTek	EMC Pro	0309207	2011/03/24	2012/03/23



9.4. Test Result and Data

Final Test Result : **PASS**
 Pass performance criteria : A
 Required performance criteria : B
 Basic Standard : IEC 61000-4-4
 Product Standard : EN 55024
 Test Voltage : On Power Supply -- ± 0.5 KV, ± 1.0 KV
 Temperature : 24°C
 Relative Humidity : 52 %
 Atmospheric Pressure : 1011 hPa
 Test Date : Aug. 05, 2011

Pulse : 5/50 ns		Repetition Rate: <u>2.5 kHz</u> above 2.0 kV			
Burst : 15m/300ms		<u>5 kHz</u> below and equal 2.0Kv			
Test time : 1 min/each condition		<u>0.5 kV</u>		<u>1.0 kV</u>	
Voltage/ Mode/ Polarity/ Result/ Phase		+	-	+	-
Power Line	L	A	A	A	A
	N	A	A	A	A
	L-N	A	A	A	A

Note: "A" Means the EUT function is normal working during the test.

Test engineer: Yora



9.5. Test Photographs

Front View

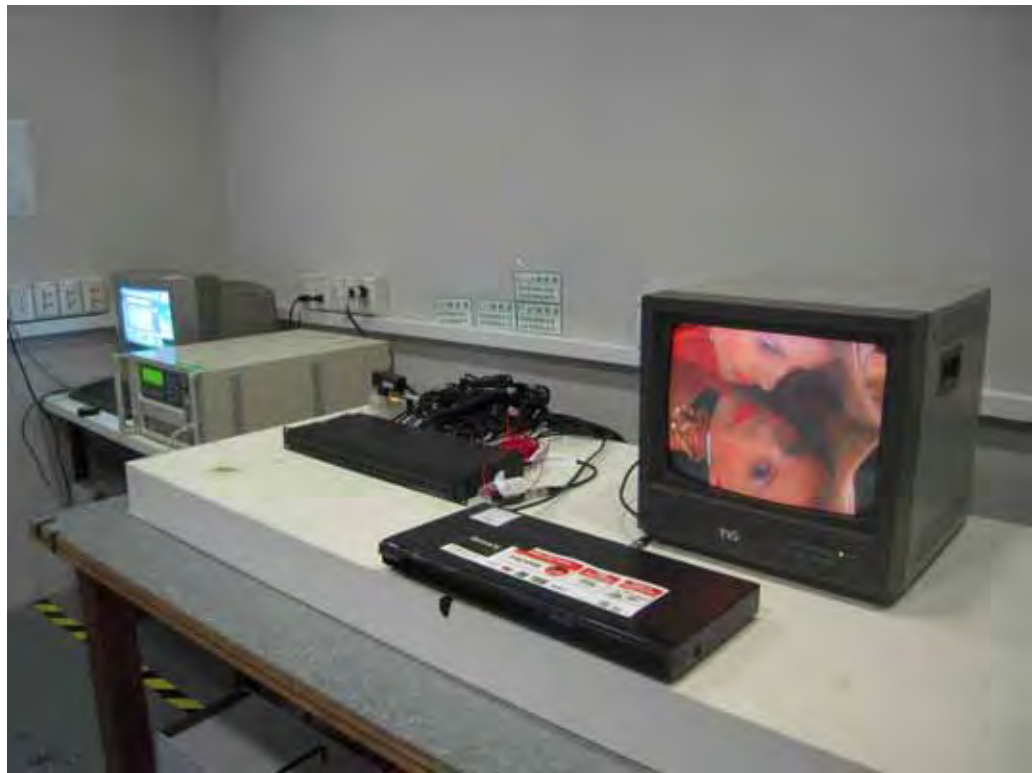

Rear View





10. Surge Immunity Test

10.1. Test Procedure

- a. Climatic conditions
The climatic conditions shall comply with the following requirements :
 - ambient temperature : 15 to 35
 - relative humidity : 10 % to 75 %
 - atmospheric pressure : 86 kPa to 106 kPa (860 mbar to 1060 mbar)
- b. Electromagnetic conditions
the electromagnetic environment of the laboratory shall not influence the test results.
- c. The test shall be performed according the test plan that shall specify the test set-up with
 - generator and other equipment utilized;
 - test level (voltage/current);
 - generator source impedance;
 - internal or external generator trigger;
 - number of tests : at least five positive and five negative at the selected points;
 - repetition rate : maximum 1/min.
 - inputs and outputs to be tested;
 - representative operating conditions of the EUT;
 - sequence of application of the surge to the circuit;
 - phase angle in the case of AC. power supply;
 - actual installation conditions, for example :
 - AC : neutral earthed,
 - DC : (+) or (-) earthed to simulated the actual earthing conditions.
- d. If not otherwise specified the surges have to be applied synchronized to the voltage phase at the zero-crossing and the peak value of the AC. voltage wave (positive and negative).
- e. The surges have to be applied line to line and line(s) and earth. When testing line to earth, the test voltage has to be applied successively between each of the lines and earth, if there is no other specification.
- f. The test procedure shall also consider the non-linear current-voltage characteristics of the equipment under test. Therefore the test voltage has to be increased by steps up to the test level specified in the product standard or test plan.
- g. All lower levels including the selected test level shall be satisfied. For testing the secondary protection, the output voltage of the generator shall be increased up to the worst-case voltage breakdown level (let-through level) of the primary protection.
- h. If the actual operating signal sources are not available, that may be simulated. Under no circumstances may the test level exceed the product specification. The test shall be carried out according to a test plan.
- i. To find all critical points of the duty cycle of the equipment, a sufficient number of positive and negative test pulses shall be applied. For acceptance test previously unstressed equipment shall be used to the protection devices shall be replaced.



10.2. Test Severity Level

Level	Open-circuit test voltage, $\pm 10\%$, KV
1	0.5
2	1.0
3	2.0
4	4.0
X	Specified

NOTE: "X" is an open class. This level can be specified in the product specification.

10.3. Measurement Equipment

Instrument	Manufacturer	Model No.	Serial No.	Calibration Date	Valid Date
EMC Pro	KeyTek	EMC Pro	0309207	2011/03/24	2012/03/23



10.4. Test Result and Data

Final Test Result : **PASS**
 Pass performance criteria : A
 Required performance criteria : B
 Basic Standard : IEC 61000-4-5
 Product Standard : EN 55024
 Test Voltage : Input AC Power Port L-N -- ± 0.5 kV, ± 1.0 kV
 Temperature : 24°C
 Relative Humidity : 52 %
 Atmospheric Pressure : 1011 hPa
 Test Date : Aug. 05, 2011

Power Port

Waveform : 1.2/50 μ s(8/20 μ s)		Repetition rate : 60 sec		Time : 5 time/each condition		
Phase Voltage / Mode / Polarity / Result			0°	90°	180°	270°
0.5 kV, 1.0kV	L-N	+	A	A	A	A
		-	A	A	A	A

Note: "A" Means the EUT function is normal working during the test.

Test engineer: Yosa



10.5. Test Photographs

Front View



Rear View





11. Conduction Disturbances induced by Radio-Frequency Fields

11.1. Test Procedure

- a. The EUT shall be operated within its intended climatic conditions. The temperature and relative humidity should be recorded.
- b. This test method test can be performed without using a sell shielded enclosure. This is because the disturbance levels applied and the geometry of the setups are not likely to radiated a high amount of energy, especially at the lower frequencies. If under certain circumstances the radiated energy is too high, a shielded enclosure has to be used.
- c. The test shall be performed with the test generator connected to each of the coupling and decoupling devices in turn while the other non-excited RF-input ports of the coupling devices are terminated by a 50 ohm load resistor.
- d. The frequency range is swept from 150 KHz to 80 MHz, using the signal levels established during the setting process, and with the disturbance signal 80% amplitude modulated with a 1KHz sign wave, pausing to adjust the RF-signal level or to switch coupling devices as necessary. The rate of sweep shall no exceed 1.5×10^{-3} decades/s. Where the frequency is swept incrementally, the step size shall no exceed 1% of the start and thereafter 1% of the preceding frequency value.
- e. The dwell time at each frequency shall not be less than the time necessary for the EUT to be exercised, and able to respond. Sensitive frequencies e.g. clock frequency (ies) and harmonics or frequencies of dominant interest shall be analyzed separately.
- f. An alternative test procedure may be adopted, wherein the frequency range is swept incrementally, with a step size not exceeding 4% of the start ad thereafter 4% of the preceding frequency value. The test level should be at least twice the value of the specified test level.
- g. In cases of dispute, the test procedure using a step size not exceeding 1% of the start and thereafter 1% of preceding frequency value shall take precedence.
- h. Attempts should be made to fully exercise the EUT during testing, and to fully interrogate all exercise modes selected for susceptibility.
- i. The use of special exercising programs is recommended.
- j. Testing shall be performed according to a Test Plan, which shall be included in the test report.
- k. It may be necessary to carry out some investigatory testing in order to establish some aspects of the test plan.



11.2. Test Severity Levels

Level	Voltage Level (EMF)
1	1 V
2	3 V
3	10 V
x	Specified

NOTE - x is an open class. This level can be specified in the product specification.

11.3. Measurement Equipment

Instrument	Manufacturer	Model No.	Serial No.	Calibration Date	Valid Date
CS GENERATOR	Schaffner	NSG 2070	1059	2010/10/06	2011/10/05
CDN (M2+M3)	Schaffner	M016	20056	2010/10/05	2011/10/04
CDN	Schaffner	T400	19818	2010/10/05	2011/10/04
EM-CLAMP	Schaffner	KEMZ 801	19793	2010/10/05	2011/10/04



11.4. Test Result and Data

Final Test Result : **PASS**
 Pass performance criteria : A
 Required performance criteria : A
 Basic Standard : IEC 61000-4-6
 Product Standard : EN 55024
 Coupling mode : CDN-(M2) for AC power ports
 Temperature : 24°C
 Relative Humidity : 52 %
 Atmospheric Pressure : 1011 hPa
 Test Date : Aug. 05, 2011

Frequency : 0.15~80MHz, Modulation : AM 80%, 1KHz sine wave, Dwell time: 2.9s Frequency Step Size : 1 % of preceding frequency value			
Frequency	Test Mode	Voltage(V)	Result
0.15 ~ 80MHz	Power(M2)	3	A

Note: "A" Means the EUT function is normal working during the test.

Test engineer: Yosa



11.5. Test Photographs

Front View



Rear View

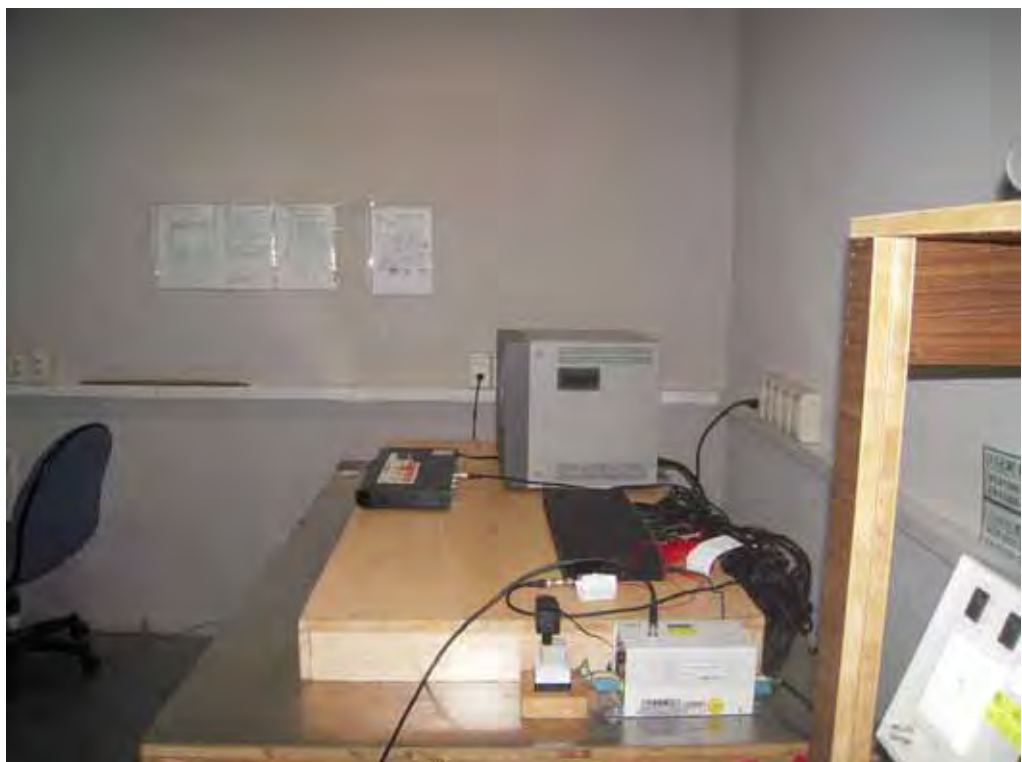

12. Power Frequency Magnetic Field Immunity Test

12.1. Test Setup

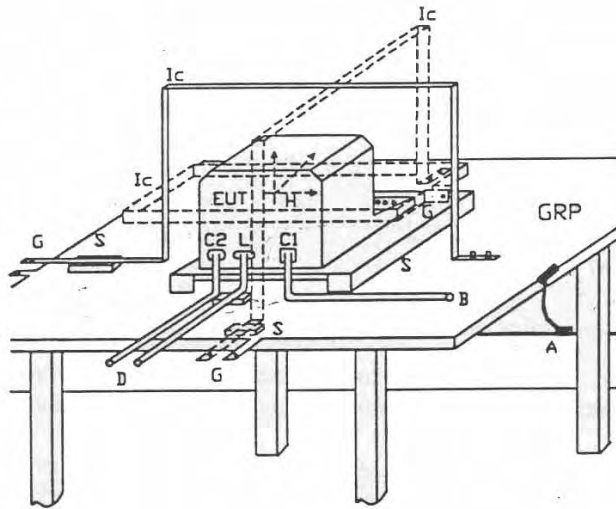

- | | | | |
|-----|------------------------|----|-------------------------------|
| GPR | : Ground plane | C1 | : Power supply circuit |
| A | : Safety earth | C2 | : Signal circuit |
| S | : Insulating support | L | : Communication line |
| EUT | : Equipment under test | B | : To power supply source |
| Lc | : Induction coil | D | : To signal source, simulator |
| E | : Earth terminal | G | : To the test generator |

12.2. Test Severity Levels

Level	Magnetic field strength A/m
1	1
2	3
3	10
4	30
5	100
X ¹⁾	special

NOTE 1 "X" is an open level. This level can be given in the product specification.

12.3. Measurement Equipment

Instrument	Manufacturer	Model No.	Serial No.	Calibration Date	Valid Date
MAGNETIC FIELD GENERATOR	KeyTek	F-1000-4-8-G-125A	N/A	2010/10/05	2011/10/04



12.4. Test Result and Data

Final Test Result : **PASS**
Pass performance criteria : A
Required performance criteria : A
Basic Standard : IEC 61000-4-8
Product Standard : EN 55024
Temperature : 24°C
Relative Humidity : 52 %
Atmospheric Pressure : 1011 hPa
Test Date : Aug. 05, 2011

Power Frequency Magnetic Field : <u>50</u> Hz, <u>1</u> A/m		
Coil Orientation	Testing duration	Results
X-axis	1.0 Min	A
Y-axis	1.0 Min	A
Z-axis	1.0 Min	A

Note: "A" Mean the EUT function is normal working during the test.

Test engineer: Dora



12.5. Test Photographs

Front View



Rear View

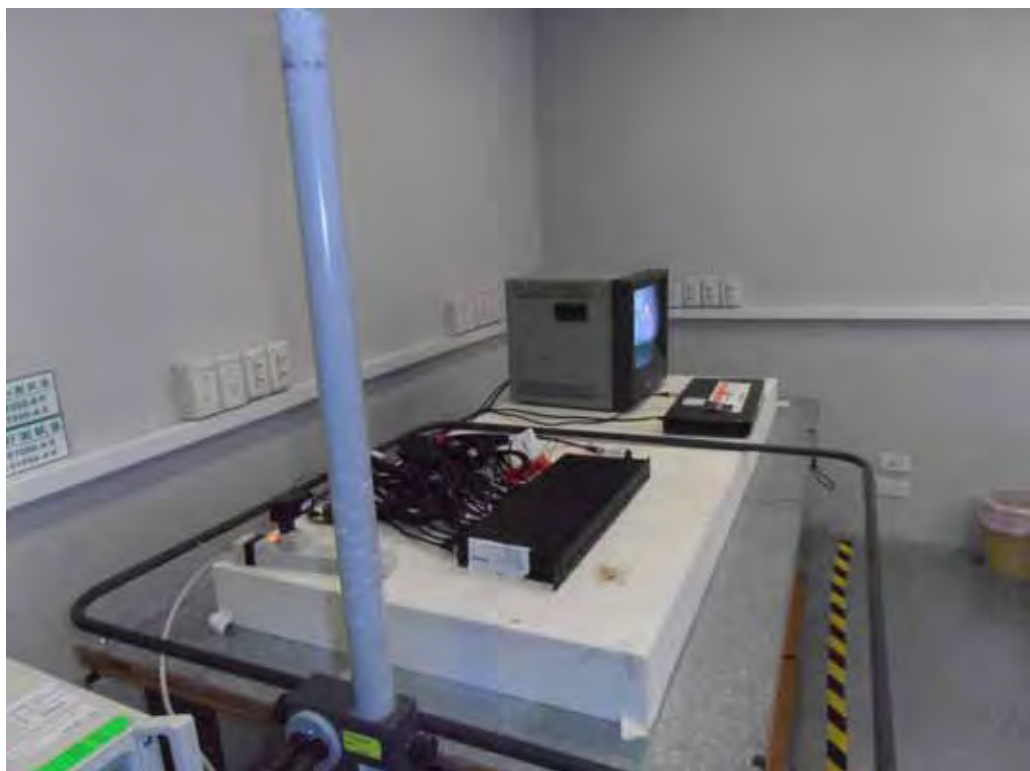



13. Voltage Dips and Voltage Interruptions Immunity Test Setup

13.1. Test Conditions

1. Source voltage and frequency : 230V / 50Hz, Single phase.
2. Test of interval : 10 sec.
3. Level and duration : Sequence of 3 dips/interrupts.
4. Voltage rise (and fall) time : 1 ~ 5 μ s.
5. Test severity :

Voltage dips and Interrupt reduction (%)	Test Duration (period)
>95%	250
30%	25
>95%	0.5

13.2. Measurement Equipment

Instrument	Manufacturer	Model No.	Serial No.	Calibration Date	Valid Date
EMC Pro	KeyTek	EMC Pro	0309207	2011/03/24	2012/03/23



13.3. Test Result and Data

Final Test Result : **PASS**
 Pass performance Criteria : B for voltage interruption, A for voltage dips
 Required performance Criteria : C for voltage interruption, B/C for voltage dips
 Basic Standard : IEC 61000-4-11
 Product Standard : EN 55024
 Temperature : 24°C
 Relative Humidity : 52 %
 Atmospheric Pressure : 1011 hPa
 Test Date : Aug. 05, 2011

Voltage(UT): AC <u>230</u> V <u>50</u> Hz Interval(s) : <u>10s</u> Times : <u>3</u>				
Test mode	Test level reduction %	Durations (period)	Phase / Result	
			0°	180°
Voltage interruptions	>95%	250	B	B
Voltage dips	30%	25	A	A
	>95%	0.5	A	A

Note: "A" Means the EUT function is normal working during the test.

"B" Means the EUT function is affect during the test, but it can be recover automatically, after a while.

Test engineer: Dora



13.4. Test Photographs

Front View



Rear View





Appendix A. Photographs of EUT







