

HomeTek Technology Inc.

ADDRESS: No. 67-9, Shir Men Road, Tu Cheng City,
Taipei Hsien, Taiwan

PHONE : 886-2-22608375 FAX : 886-2-22748013

E - mail : hometek@ms15.hinet.net

FCC TEST REPORT FOR

APPLICANT	: <u>SMART CABLING & TRANSMISSION CORP.</u>
ADDRESS	: <u>10F, No. 493, Chung-Cheng Rd.,</u> <u>Hsin Tien City, Taipei 231, Taiwan, R. O. C.</u>
EUT	: <u>CAT5 AV Multimedia Transmission</u>
MODEL NO.	: <u>TTPXXXAV</u>



Accredited by the National Voluntary Laboratory Accreditation Program
for the specific scope of accreditation under Lab Code 200331-0

MEASUREMENT PROCEDURE USED

FCC RULES AND CISPR 22-1997 AND FCC / ANSI C63.4-2003

PREPARED BY :

HomeTek Technology Inc.

No. 67-9, Shir Men Road, Tu Cheng City,

Taipei Hsien. Taiwan

Report # : FD5F013



TABLE OF CONTENTS 2

CERTIFICATION 3

GENERAL INFORMATION..... 4

MODIFICATION LIST..... 6

CONDUCTED POWER LINE TEST 7

 1 TEST PROCEDURE 7

 2 RESULT OF CONDUCTED EMISSION TEST 7

RADIATED EMISSION TEST 8

 1 TEST INSTRUMENTS & FACILITIES 8

 2 TEST PROCEDURE 9

 3 TEST SETUP 9

 4 CONFIGURATION OF THE EUT11

 5 EUT OPERATING CONDITION15

 6 LIMIT OF RADIATED EMISSION CLASS B15

 7 RESULT OF RADIATED EMISSION TEST16

 8 RADIATED EMISSION TEST DATA (PAGE 1)17

 9 RADIATED EMISSION TEST DATA (PAGE 2)18

SAMPLE OF FCC DOC LABEL 1.....19

SAMPLE OF FCC DOC LABEL 2.....19

APPENDIX A

PHOTOS OF TEST CONFIGURATION

APPENDIX B

PHOTOS OF EUT

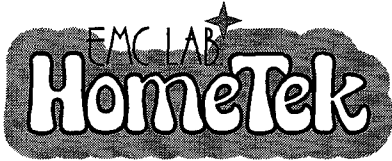

HomeTek Technology Inc.

ADDRESS: No. 67-9, Shir Men Road, Tu Cheng City,
Tapei Hsien, Taiwan
PHONE : 886-2-22608375 FAX : 886-2-22748013
E - mail : hometek@ms15.hinet.net

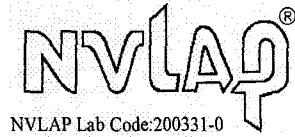

CERTIFICATION

for
FCC Part 15, Subpart B Class B

APPLICANT : SMART CABLING & TRANSMISSION CORP.
ADDRESS : 10F, No. 493, Chung-Cheng Rd.,
Hsin Tien City, Taipei 231, Taiwan, R. O. C.
Receipt Date : 06/15/2006 Final Test Date: 06/26/2006
EUT : CAT5 AV Multimedia Transmission
MODEL NO. : TTPXXXAV

MEASUREMENT PROCEDURE USED :

PART 15 SUBPART B FCC RULES AND CISPR 22-1997
AND FCC / ANSI C63.4-2003

TEST PROCEDURE AND DATA ARE TRACEABLE TO NIST/USA,
TL or NML/TAIWAN.

- THE MAXIMUM EMISSION LEVELS WERE COMPARED TO THE CISPR 22 CLASS B LIMITS BOTH RADIATED AND CONDUCTED EMISSION.
- THE ABOVE DEVICE WAS TESTED BY HOMETEK TECHNOLOGY INC. TO SHOWS THE MAXIMUM EMISSION LEVEL FROM THE DEVICE.
- THIS TEST RESULTS OF THIS REPORT APPLIES TO ABOVE TESTED SAMPLE ONLY.
- THIS TEST REPORT SHALL NOT BE REPRODUCE IN PART WITHOUT WRITTEN APPROVAL OF HOMETEK TECHNOLOGY INC.
- THE REPORT MUST NOT BE USED BY THE CLIENT TO CLAIM PRODUCT ENDORSEMENT BY NVLAP OR ANY AGENCY OF THE U. S. GOVERNMENT.
- THE TEST RESULTS ARE TRACEABLE TO THE NATIONAL OR INTERNATIONAL STANDARD.

APPROVED BY : *Alain Lin 6/29/2006*

ALAIN LIN / Supervisor

GENERAL INFORMATION

- 1 APPLICANT : SMART CABLING & TRANSMISSION CORP.
- 2 ADDRESS : 10F, No. 493, Chung-Cheng Rd.,
Hsin Tien City, Taipei 231, Taiwan, R. O. C.
- 3 MANUFACTURER : SMART CABLING & TRANSMISSION CORP.
- 4 ADDRESS : 10F, No. 493, Chung-Cheng Rd.,
Hsin Tien City, Taipei 231, Taiwan, R. O. C.
- 5 DESCRIPTION OF EUT :
- EUT : CAT5 AV Multimedia Transmission
- FCC ID : N/A
- Model Number : TTPXXXAV
- Serial # : N/A

5.1 The difference between series of models TTPXXXAV are as shown below:

- (1) The first and second "X" represents different system input.
- (2) The third "X" represent different accessory.

The PCB layout is similar. The worst case of EMI test data were shown in this test report.

6 FEATURES OF EUT :

Please refer to user manual or product specification.

7 TEST MODE :

The EUT were investigated with two operation modes shown as below :

- (1) Video 1 Mode;
- (2) Video 2 Mode

The test mode of (1) Video 1 Mode is worst case, and the final test data were shown in this test report.



MODIFICATION LIST

THE FOLLOWING ACCESSORIES WERE ADDED TO THE EUT DURING TESTING :

NO MODIFICATION BY HOMETEK TECHNOLOGY INC.

CONDUCTED POWER LINE TEST

1 TEST PROCEDURE

According to **ANSI C63.4 – 2003 & CISPR 22 - 1997.**

2 RESULT OF CONDUCTED EMISSION TEST

N/A (Conducted Power Line Test is not applicable to this EUT (Model : TTP212AV)).

RADIATED EMISSION TEST

1 TEST INSTRUMENTS & FACILITIES

The following test Instruments was used during the radiated emission test :

Item	Instruments /facilities	Specification	Manufacturer	Model # / S/N#	Date of Cal.
1	OPEN AREA TEST SITE	<input checked="" type="checkbox"/> OATS 3			JUL/2005
2	EMI TEST RECEIVER	20Hz ~ 26.5GHz	ROHDE & SCHWARZ	ESMI 845442/006	FEB/2006
3	PRE-AMPLIFIER	9KHz ~ 3000MHz	ADVANTEST	BB525C 90081001	OCT/2005
4	ANTENNA (BI-LOG)	25MHz ~ 2GHz	SCHAFFNER	CBL6112B S/N : 2614	JUN/2006
5	Attenuation	50Ω/6dB	JYE BAO	FAT-N (M-F) 001	JUL/2005
6	Cable	10m	SUHNER	RG214/U OS3-003	DEC/2005
7	Cable	14m	BELDEN	9913 OS3-001	DEC/2005
8	EMI 32 (software)	N/A	AUDIX	19991013-0923	N/A

Note : Items 1 ~ 7 were calibrated within period of 1 year.

2 TEST PROCEDURE

- 2.1 The EUT was test according to **ANSI C63.4 – 2003 Section 5.4, 5.5, 8.1, 8.2, 8.3 & CISPR 22 - 1997 & C18-01-11 (HomeTek test procedure)**.
- 2.2 The radiated test was performed at HomeTek Lab's Open Site III.
- 2.3 The frequency range from 30 MHz to 1 GHz, the measurement were made at 10 meters, with a BI-log antenna.

3 TEST SETUP

3.1 TEST SETUP OF OPEN SITE.

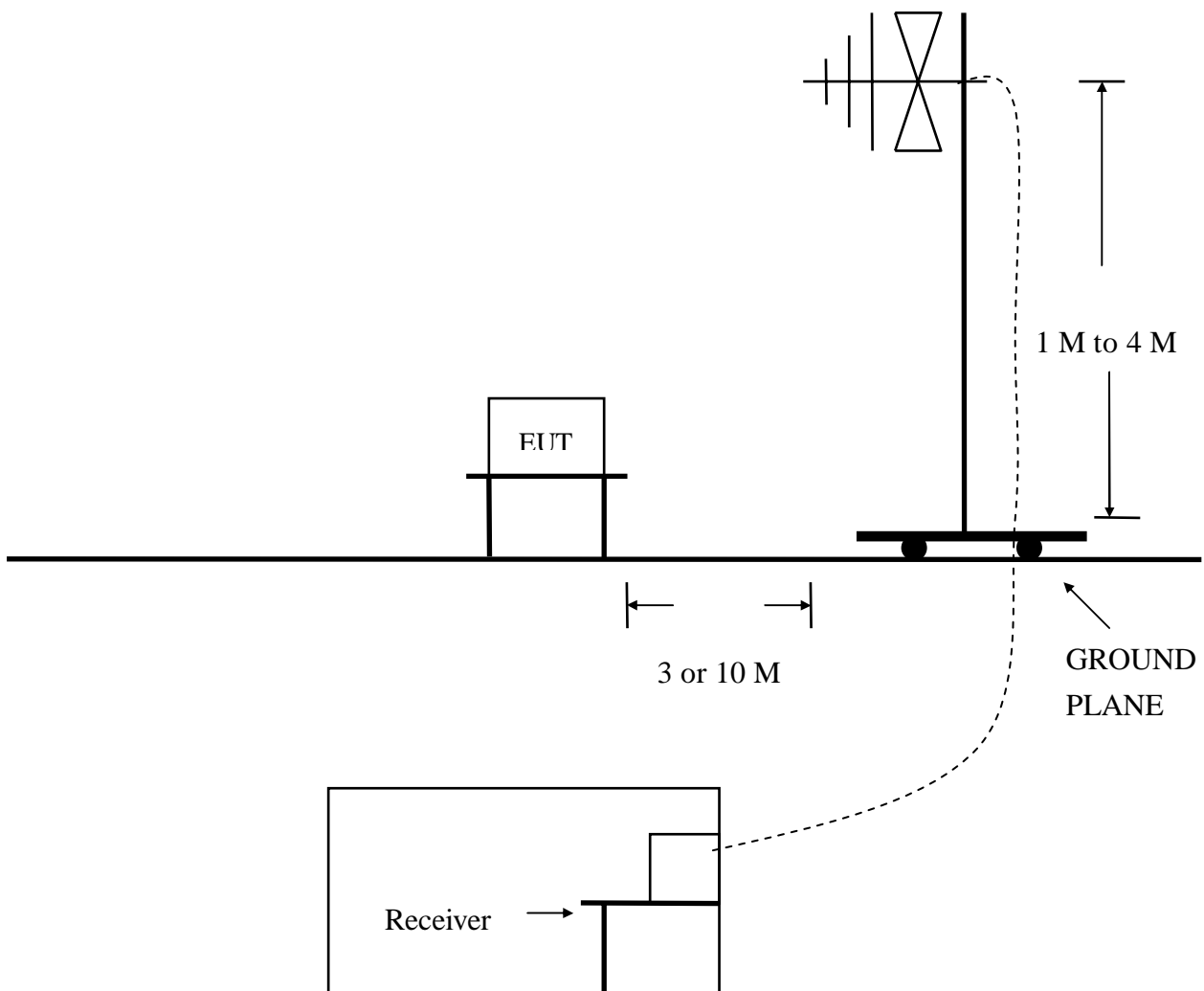

3.2 TEST SETUP OF EUT

ELECTRICAL AND ELECTRONIC EQUIPMENT IN THE RANGE OF 9kHz TO 40 GHz ANSI C63.4-2003

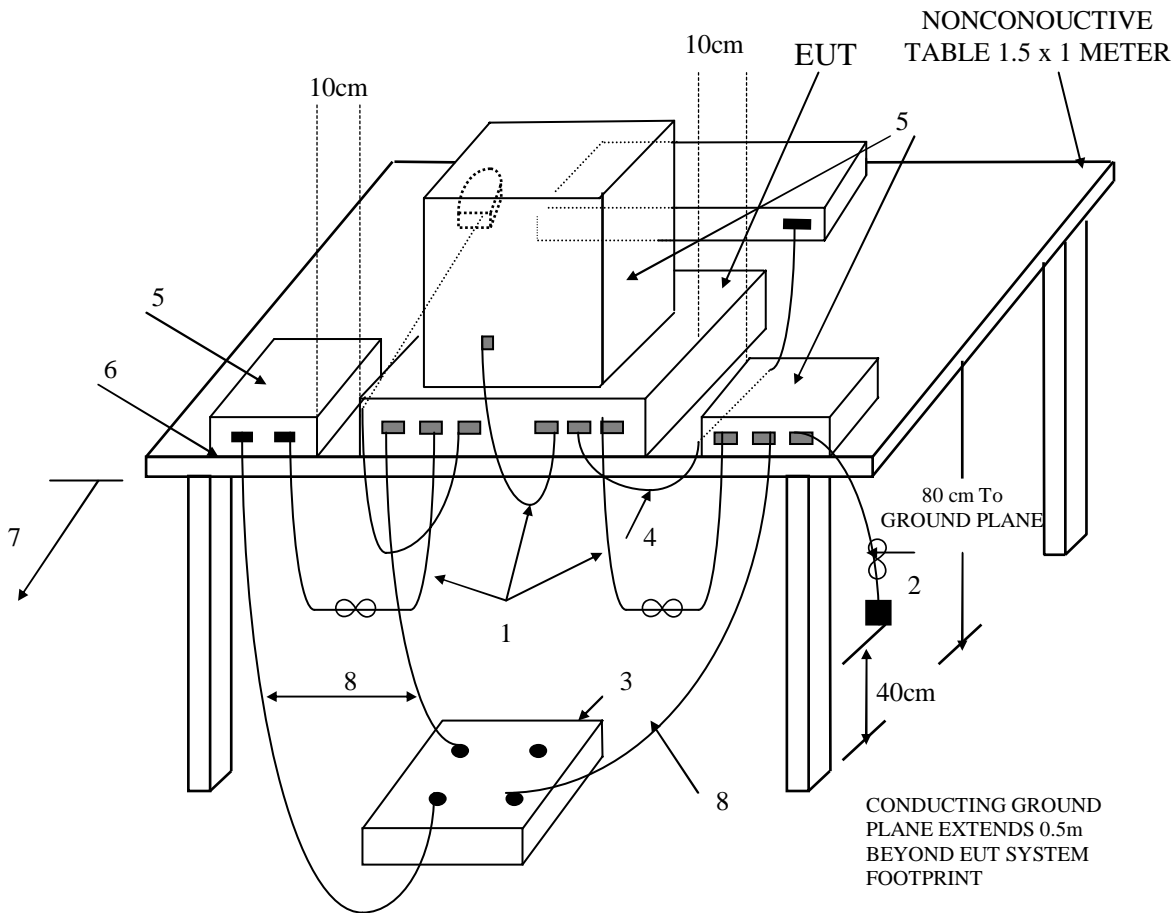

(Details for setup configuration, please refer to appendix A.)

LEGEND:

1. Interconnecting cables that hang closer than 40 cm to the ground plane shall be folded back and forth forming a bundle 30 to 40 cm long, hanging approximately in the middle between ground plane and table.
2. I/O cables that are connected to a peripheral shall be bundled in center. The end of the cable may be terminated if required using correct terminating impedance. The total length shall not exceed 1m.
3. If LISNs are kept in the test setup for radiated emissions, it is preferred that they be installed under the ground plane with the receptacle flush with the ground plane.
4. Cables of hand-operated devices, such as keyboards, mice, etc., have to be placed as close as possible to the controller.
5. Non-EUT components of EUT system being tested.
6. The rear of all components of the system under test shall be located flush with the rear of the table.
7. No vertical conducting wall used.
8. Power cords drape to the floor and are routed over to receptacle.

**Test Configuration
Tabletop Equipment Radiated Emission**

4 CONFIGURATION OF THE EUT

The EUT was configured according to **ANSI C63.4 – 2003**. All I/O ports were connected to the appropriate peripherals. All peripherals and cables are listed below (including internal device) :

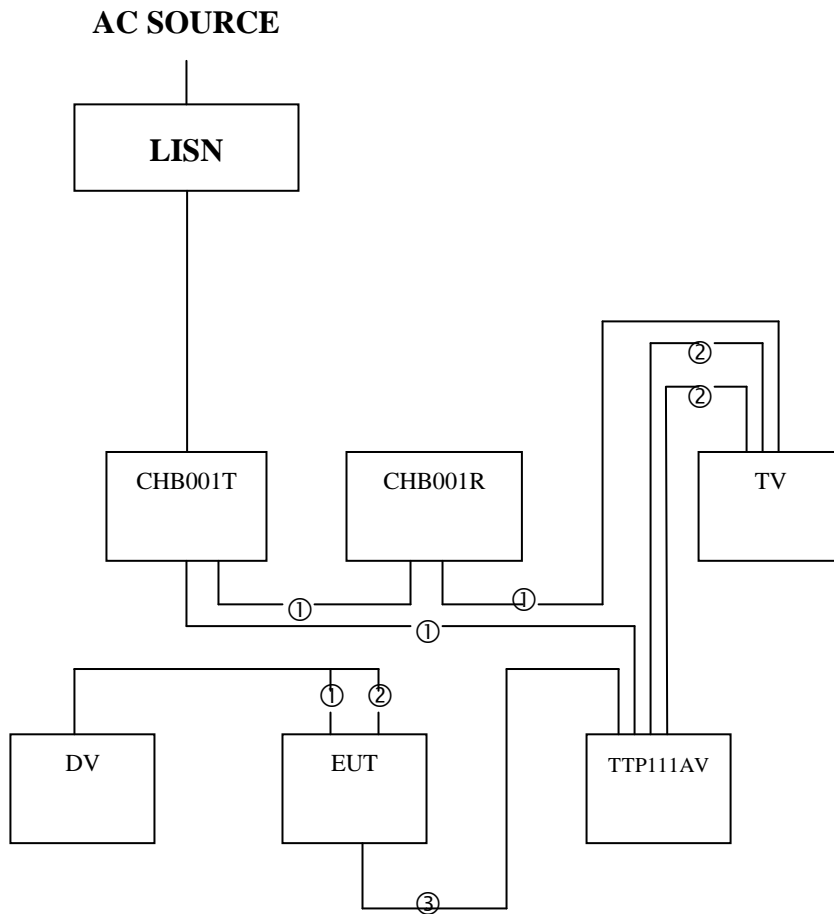

- ① Video Cable
- ② Audio Cable
- ③ RJ-45 Cable

Figure 1



4.1 EUT

EUT Type : Proto Type Engineer Type Mass Production
Condition when received : Good Damage : _____
Device : CAT5 AV Multimedia Transmission
Applicant : SMART CABLING & TRANSMISSION CORP.
Manufacturer : SMART CABLING & TRANSMISSION CORP.
Model Number : TTPXXXAV
Serial Number : N/A
FCC ID : N/A
RJ-45 Port : Plastic Type
Video Port x 2 : Metal Type
Audio Port x 2 : Metal Type
Power Cord : N/A
Power Supply Type : N/A

4.2 PERIPHERALS

DV

Manufacturer : SONY
Model Number : DCR-PC110
Serial Number : 1158142
FCC ID : FCC DoC
Data Cable 1 : Shielded, 1.8 m, Connect to the Video port
Data Cable 2 : Shielded, 1.8 m, Connect to the Audio port
Power Cord : Un-Shielded, 1.8 m



TV

Manufacturer : TCL
Model Number : 1419A
Serial Number : N/A
FCC ID : N/A
Data Cable 1 : Shielded, 1.0 m, Connect to the Video port
Data Cable 2 x 2 : Shielded, 1.5 m, Connect to the Audio port
Power Cord : Un-Shielded, 1.8 m

CAT5 AV Multimedia Transmission

Manufacturer : SMART CABLING & TRANSMISSION CORP.
Model Number : TTP111AV
Serial Number : N/A
FCC ID : N/A
Data Cable 1 : Shielded, 1.8 m, Connect to the Video port
Data Cable 2 x 2 : Shielded, 1.8 m, Connect to the Audio port
Data Cable 3 : Un-Shielded, 1.0 m, Connect to the RJ-45 port
Power Cord : N/A

Video Interference Blocker 1

Manufacturer : SMART CABLING & TRANSMISSION CORP.
Model Number : CHB001T
Serial Number : N/A
FCC ID : N/A
Data Cable x 2 : Shielded, 1.0 m, Connect to the Video port
Power Cord : N/A



Video Interference Blocker 2

Manufacturer : SMART CABLING & TRANSMISSION CORP.

Model Number : CHB001R

Serial Number : N/A

FCC ID : N/A

Data Cable x 2 : Un-Shielded, 1.0 m, Connect to the Video port

Power Cord : N/A

4.3 REMARK : N/A

5 EUT OPERATING CONDITION

5.1 The frequency of the EUT is none.

5.2 The radiated emission in the frequency range from 30 MHz - 1000 MHz was test in a horizontal and vertical polarization at HomeTek Lab's open site III.

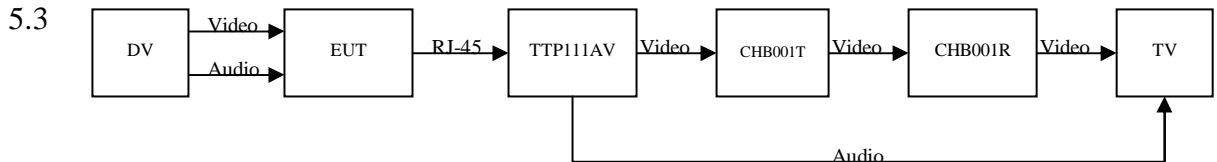

5.4 TV receivers DV's video signal (color bar) through CHB001T, CHB001R, TTP111AV, EUT via video cable or RJ-45 cable.

5.5 TV receivers DV's audio signal (1KHz audio) through TTP111AV and EUT via audio cable or RJ-45 cable.

5.6 TV display color bar and measure the emission noise.

5.7 The photos of radiated test configuration, please refer to appendix A.

6 LIMIT OF RADIATED EMISSION CLASS B

CISPR 22

Frequency (MHz)	Measurement Distance	Limit (dBuV/m)
30 - 230	10 (M)	30
230 - 1000	10 (M)	37

6.1 The tighter limit shall apply at the edge between two frequency bands.

6.2 Measurement distance in meters between the measuring instrument antenna and the closed point of any part of the EUT or peripherals.

7 RESULT OF RADIATED EMISSION TEST

- 7.1 The frequency range from 30 MHz to 1 GHz was investigated.
- 7.2 All readings below or equal 1 GHz are quasi-peak or peak values with resolution bandwidth of 120 KHz.
- 7.3 All readings above 1 GHz are average or peak values with resolution bandwidth of 1 MHz
- 7.4 The measurements were made at 10 meters of HomeTek Lab's open site III.
- 7.5 Temperature : 31 °C, Humidity : 51 % RH.
- 7.6 Deviation form the test standards and rules : None
- 7.7 The radiation emission result were gained by the following method :
Level = Reading Level + Probe Factor (Antenna Factor) + Cable Loss – Preamp Factor
Over Limit = Level – Limit Line
- 7.8 The radiated mission test was passed at minimum margin :
Vertical 113.00 MHz/ 23.60 dBuV/m, Antenna Height 1.5 Meter,
Turn Table 160 degree, Model : TTP212AV, Test Mode: Video 1 Mode .
- 7.9 Result : **PASSED**



8 RADIATED EMISSION TEST DATA (PAGE 1)



HomeTek Technology Inc.

No 67-9, Shi-Men Rd., Tu-Chen City,
Taipei County, Taiwan R.O.C.
Tel: 02-22608375
Fax: 02-22748013

Data#: 4 File#: 5F013.EMI

Date: 2006-06-26 Time: 19:54:44

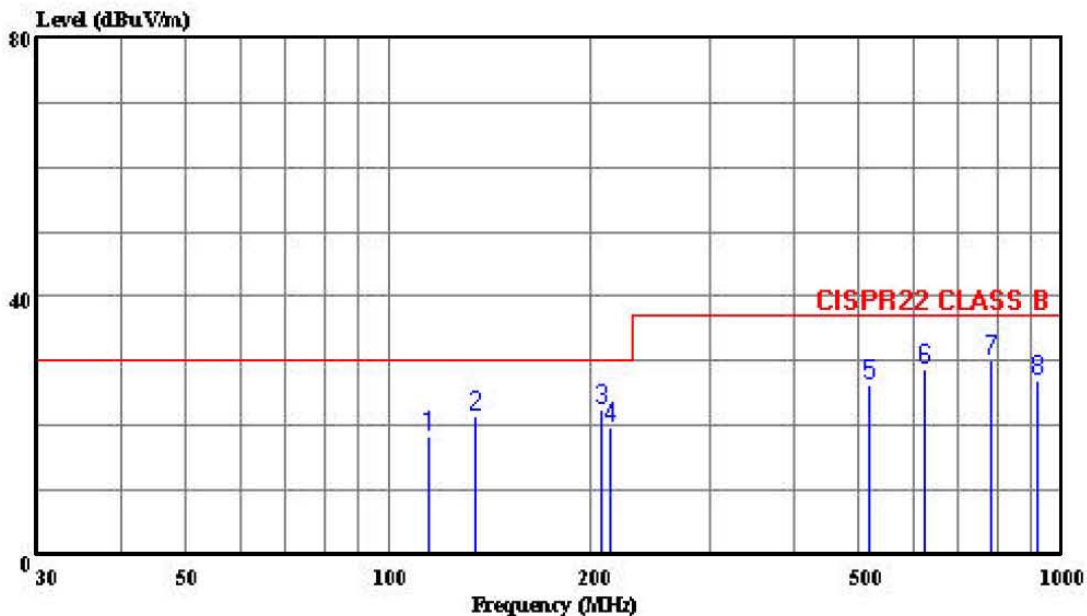

Trace:

Ref Trace:

Condition: CISPR22 CLASS B 10m CHASE 2614 060506 HORIZONTAL
cut : CAT5 AV Multimedia Transmission
power: N/A
memo : TTP212AV (Video1 Mode)

Page: 1

	Freq	Level	Limit	Over	Read	Antenna	Cable	Preamp	Remark
	MHz	dBuV/m	dBuV/m	dB	dBuV	dB/m	dB	dB	
1	114.993	18.18	30.00	-11.82	30.23	12.25	1.46	25.76	Peak
2	134.000	21.52	30.00	-8.48	34.21	11.46	1.58	25.72	Peak
3	206.480	22.44	30.00	-7.56	36.95	9.10	2.01	25.62	Peak
4	214.000	19.86	30.00	-10.14	34.33	9.10	2.04	25.61	Peak
5	518.553	26.45	37.00	-10.55	30.07	17.87	3.41	24.89	Peak
6	627.627	28.82	37.00	-8.18	30.65	18.77	3.81	24.40	Peak
7	782.573	30.01	37.00	-6.99	29.89	19.70	4.26	23.84	Peak
8	917.280	26.93	37.00	-10.07	24.65	20.50	5.15	23.36	Peak



9 RADIATED EMISSION TEST DATA (PAGE 2)



HomeTek Technology Inc.

No 67-9, Shi-Men Rd., Tu-Chen City, Taipei County, Taiwan R.O.C. Tel:02-22608375 Fax:02-22748013

Data#: 3 File#: 5F013.EMI

Date: 2006-06-26 Time: 19:01:52

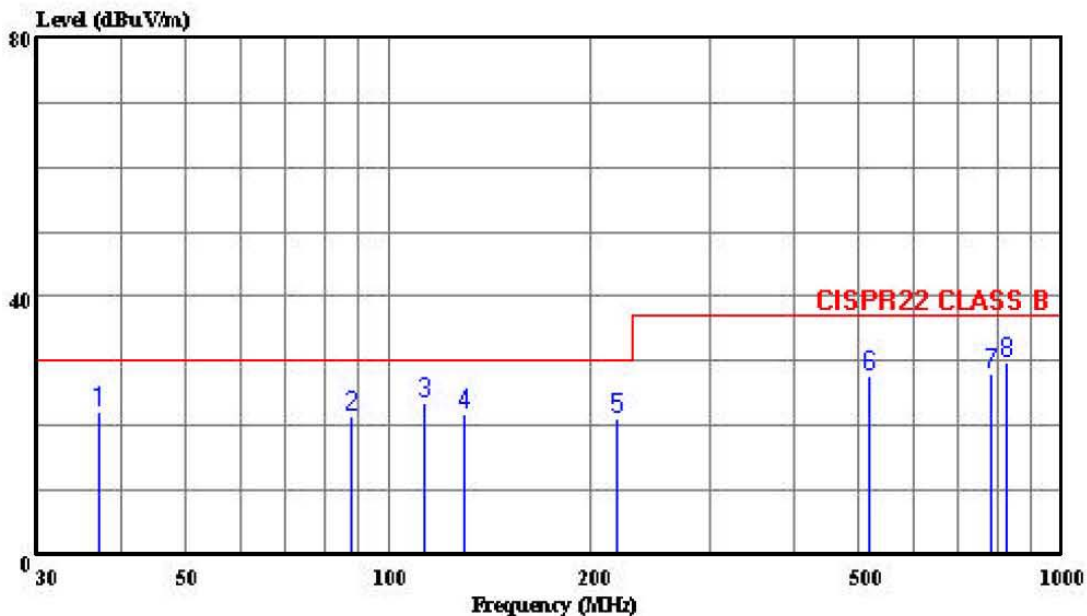

Trace:

Ref Trace:

Condition: CISPR22 CLASS B 10m CHASE 2614 060506 VERTICAL
cut : CAT5 AV Multimedia Transmission
power: N/A
memo : TTP212AV (Video1 Mode)

Page: 1

	Freq	Level	Limit	Over	ReadAntenna	Cable	Preamp		
	MHz	dBuV/m	dBuV/m	dB	Level	Loss	Factor	Remark	
					Factor	Factor			
					dB/m	dB	dB		
1	37.000	22.18	30.00	-7.82	31.70	15.62	0.82	25.96	Peak
2	88.000	21.31	30.00	-8.69	37.21	8.65	1.27	25.82	Peak
3	113.000	23.60	30.00	-6.40	35.73	12.18	1.45	25.76	Peak
4	129.313	21.90	30.00	-8.10	34.54	11.54	1.55	25.73	Peak
5	219.000	21.25	30.00	-8.75	35.63	9.17	2.06	25.60	Peak
6	515.680	27.67	37.00	-9.33	31.42	17.76	3.39	24.91	Peak
7	782.033	27.99	37.00	-9.01	27.87	19.70	4.26	23.84	Peak
8	827.687	29.61	37.00	-7.39	28.79	20.04	4.51	23.72	Peak

SAMPLE OF FCC DoC LABEL 1

This device complies with part 15 of the FCC Rules.
Operation is subject to the following two conditions: (1)
This device may not cause harmful interference. And (2)
this device must accept any interference received, including
interference that may cause undesired operation.

SAMPLE OF FCC DoC LABEL 2



Trade Name
Model Number



HomeTek Technology Inc.

Appendix A

PHOTOS OF TEST CONFIGURATION

PHOTO OF RADIATED EMISSION TEST

Test Mode : Video1 Mode , Model : TTP212AV



Front View

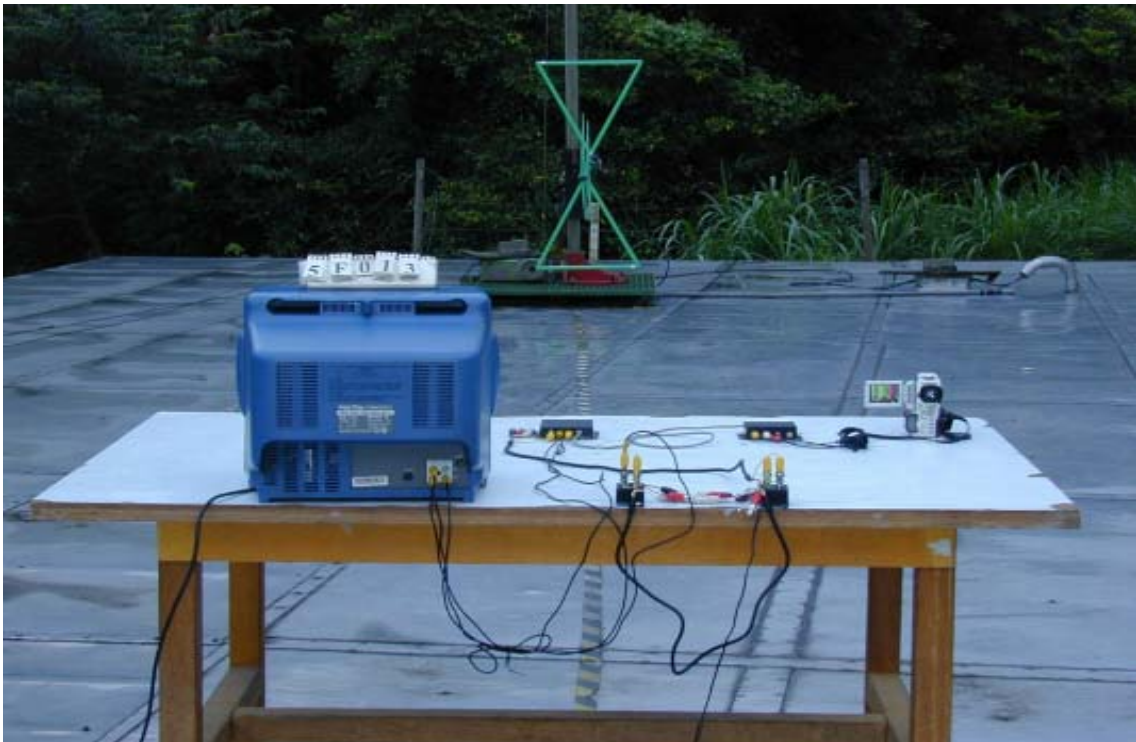

Rear View



HomeTek Technology Inc.

Appendix B

PHOTOS OF EUT

PHOTO OF EUT

Model : TTP212AV



Full View of EUT

PHOTO OF EUT

Model : TTP212AV

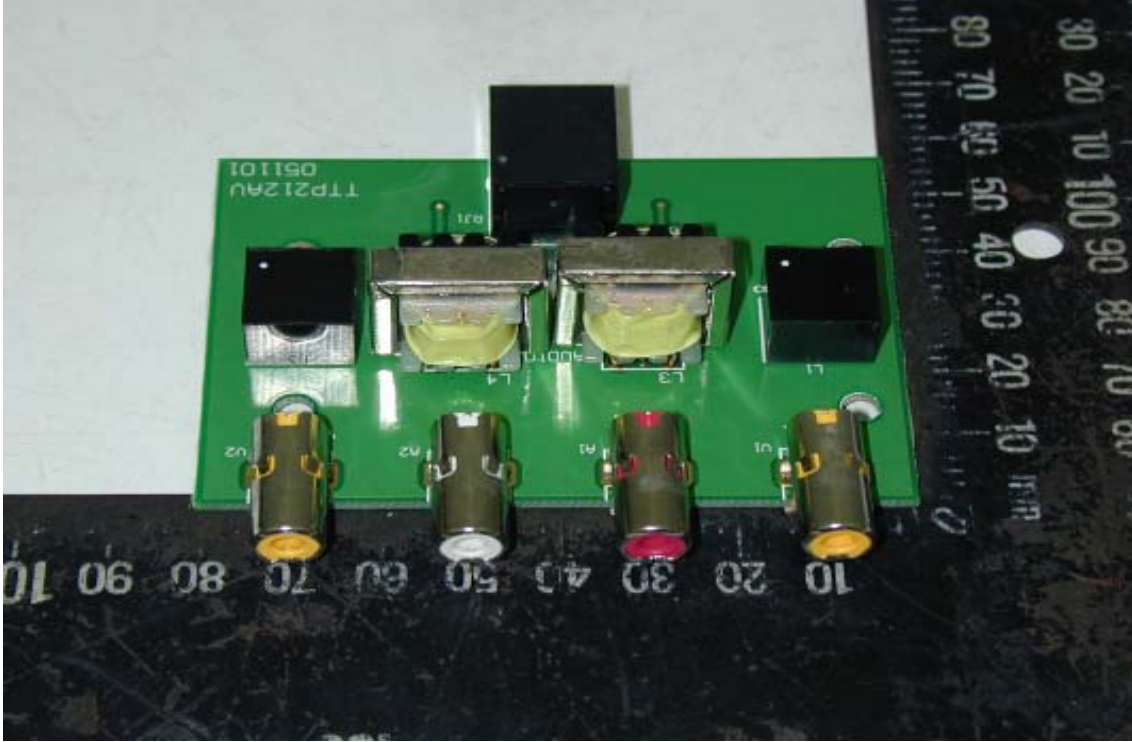

Component Side of Main Board

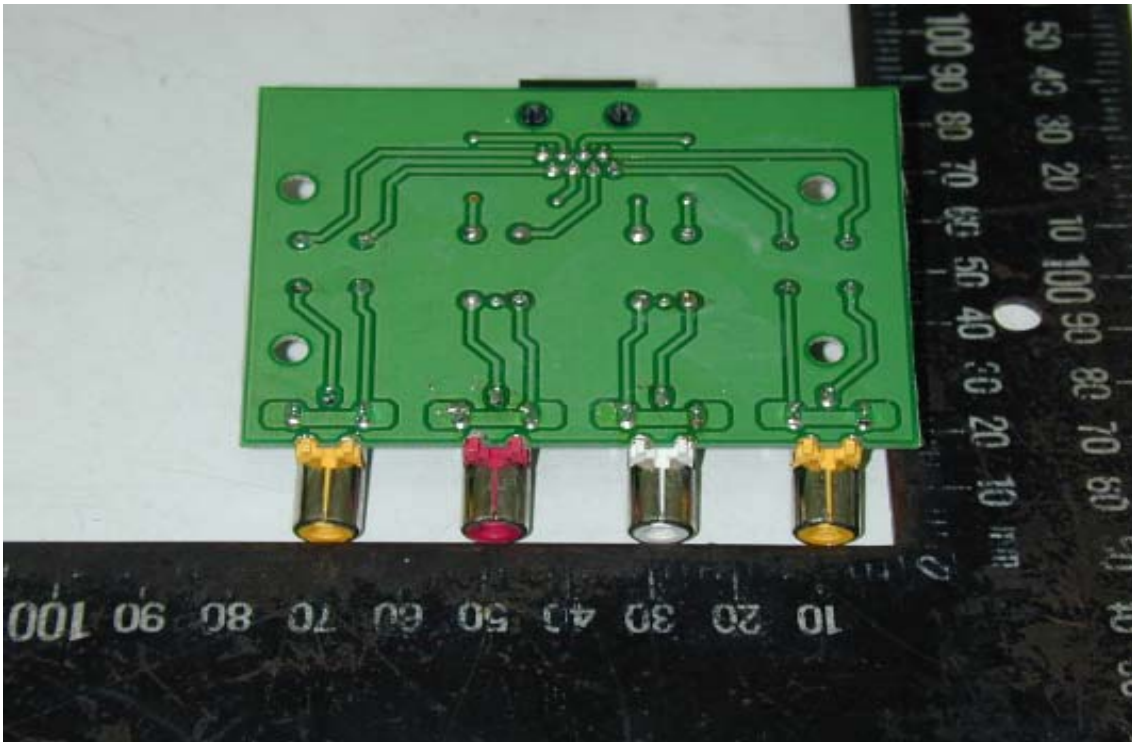

Solder Side of Main Board

Declaration of Conformity

Responsible Party Name :

Address :

Phone No :

Fax No :

Declares under our sole responsibility that the product

Product Name : CAT5 AV Multimedia Transmission

Model No. : TTPXXXAV

to which this declaration relates is in conformity with the following standards or other normative documents

This device complies with Part 15 of the FCC Rules. Operation is subject to the following two conditions : (1) this device may not cause harmful interference, and (2) this device must accept any interference received, including interference that may cause undesired operation.

Representative Person's Name : _____

Signature : _____

Date : _____

United States Department of Commerce
National Institute of Standards and Technology

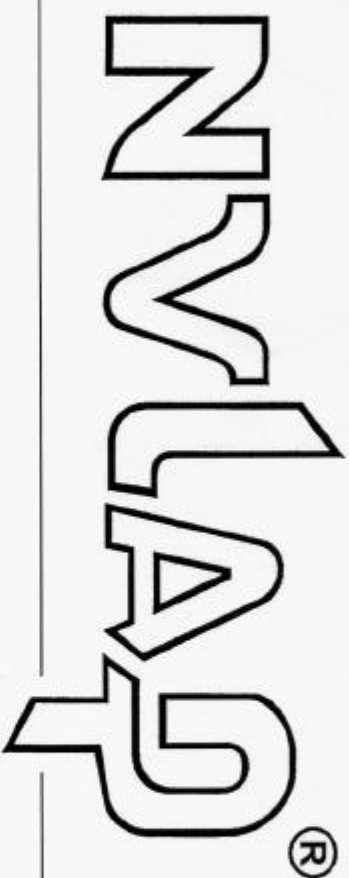

Certificate of Accreditation to ISO/IEC 17025:1999

NVLAP LAB CODE: 200331-0

HomeTek Technology Inc.

Taipei Shien 236
TAIWAN

*is recognized by the National Voluntary Laboratory Accreditation Program for conformance with criteria set forth in
NIST Handbook 150:2001 and all requirements of ISO/IEC Guide 17025:1999.
Accreditation is granted for specific services, listed on the Scope of Accreditation, for:*

ELECTROMAGNETIC COMPATIBILITY AND TELECOMMUNICATIONS

2005-10-01 through 2006-09-30

Effective dates



For the National Institute of Standards and Technology

A handwritten signature in black ink, appearing to read "John P. Ward".



SCOPE OF ACCREDITATION TO ISO/IEC 17025:1999

HomeTek Technology Inc.
P.O Box: 13-131, Pan-Chiao City
No. 67-9 Shir Men Rd., Tu Chen City
Taipei Shien 236
TAIWAN
Mr. Grant Huang
Phone: 886-2-22608375 Fax: 886-2-22748013
E-Mail: hometek@ms15.hinet.net

**ELECTROMAGNETIC COMPATIBILITY
AND TELECOMMUNICATIONS**

NVLAP LAB CODE 200331-0

NVLAP Code Designation / Description

Emissions Test Methods:

12/CIS14a	EN 55014-1 (1993), A1 (1997), A2 (1999):
12/CIS14a2	BS EN 55014-1 (2001) with A1 and A2: Electromagnetic compatibility - Requirements for household appliances, electric tools and similar apparatus - Part 1: Emission
12/CIS14b1	AS/NZS CISPR 14-1 (2003): Electromagnetic Compatibility - Requirements for household appliances, electric tools and similar apparatus - Part 1: Emission
12/CIS14c	CNS 13783-1: Electromagnetic Compatibility Requirements for household appliances, electric tools and similar apparatus - Part 1: Emissions
12/CIS14d	IEC/CISPR 14-1 (2001) and A1 (2001): Electromagnetic Compatibility - Requirements for household appliances, electric tools and similar apparatus - Part 1: Emissions
12/CIS14x	IEC/CISPR 14-1, Ed. 4 (2003): Electromagnetic Compatibility - Requirements for household appliances, electric tools and similar apparatus - Part 1: Emission
12/CIS22	IEC/CISPR 22 (1997) & EN 55022 (1998) + A1(2000): Limits and methods of measurement of radio disturbance characteristics of information technology equipment
12/CIS22a	IEC/CISPR 22 (1993) and EN 55022 (1994): Limits and methods of measurement of radio disturbance characteristics of information technology equipment, Amendment 1 (1995) and Amendment 2 (1996)

2005-10-01 through 2006-09-30

Effective dates

For the National Institute of Standards and Technology



**National Voluntary
Laboratory Accreditation Program**



**ELECTROMAGNETIC COMPATIBILITY
AND TELECOMMUNICATIONS**

NVLAP LAB CODE 200331-0

<i>NVLAP Code</i>	<i>Designation / Description</i>
12/CIS22b	CNS 13438 (1997): Limits and Methods of Measurement of Radio Interference Characteristics of Information Technology Equipment
12/CIS22c	IEC/CISPR 22, Fourth Edition (2003-04) & EN 55022 (1998): Information technology equipment - Radio disturbance characteristics - Limits and methods of measurement
12/FCC15b	ANSI C63.4 (2003) with FCC Method 47 CFR Part 15, Subpart B: Unintentional Radiators
12/T51a	AS/NZS CISPR 22 (2004): Information technology equipment - Radio disturbance characteristics - Limits and methods of measurement
12/VCCIa	VCCI: Agreement of Voluntary Control Council for Interference by Information Technology Equipment - Technical Requirements: V-3/2004.04

2005-10-01 through 2006-09-30

Effective dates

For the National Institute of Standards and Technology