



HomeTek Technology Inc.

ADDRESS: No. 67-9, Shir Men Road, Tu Cheng City,  
Taipei Hsien, Taiwan,  
PHONE : 886-2-22608375 FAX : 886-2-22748013  
E - mail : hometek@ms15.hinet.net



NVLAP Lab Code:200331-0

## EMI TEST REPORT FOR

APPLICANT : Smart Home Engineering Corp.  
ADDRESS : 10F, No. 493, Chung-Cheng Rd.,  
Hsin Tien City, Taipei 231, Taiwan, R. O. C.  
EUT : CAT5 Distributor & Extender  
MODEL NO. : VE0XXRX

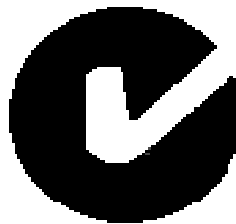

### MEASUREMENT PROCEDURE USED

AS/NZS CISPR 22: 2006 Information technology equipment – Radio disturbance characteristics – Limits and methods of measurement

PREPARED BY :  
HomeTek Technology Inc.  
No. 67-9, Shir Men Road, Tu Cheng City,  
Taipei Hsien. Taiwan  
Report # : AS6K017



**TABLE OF CONTENTS**..... 2

**CERTIFICATE** ..... 3

**GENERAL INFORMATION**..... 4

**MODIFICATION LIST**..... 6

**CONDUCTED POWER LINE TEST** ..... 7

    1 TEST INSTRUMENTS & FACILITIES..... 7

    2 TEST PROCEDURE..... 7

    3 TEST SETUP ..... 8

    4 CONFIGURATION OF THE EUT ..... 10

    5 EUT OPERATING CONDITION..... 14

    6 LIMIT OF CONDUCTED POWER LINE EMISSION CLASS B..... 14

    7 RESULT OF CONDUCTED POWER LINE TEST..... 14

    8 CONDUCTED POWER LINE TEST DATA (PAGE 1)..... 15

    9 CONDUCTED POWER LINE TEST DATA (PAGE 2)..... 16

    10 CONDUCTED POWER LINE TEST DATA (PAGE 3)..... 17

    11 CONDUCTED POWER LINE TEST DATA (PAGE 4)..... 18

**RADIATED EMISSION TEST**..... 19

    1 TEST INSTRUMENTS & FACILITIES..... 19

    2 TEST PROCEDURE..... 20

    3 TEST SETUP ..... 20

    4 CONFIGURATION OF THE EUT ..... 22

    5 EUT OPERATING CONDITION..... 22

    6 LIMIT OF RADIATED EMISSION CLASS B ..... 22

    7 RESULT OF RADIATED EMISSION TEST..... 22

    8 RADIATED EMISSION TEST DATA (PAGE 1)..... 23

    9 RADIATED EMISSION TEST DATA (PAGE 2)..... 24

**APPENDIX A**

PHOTOS OF TEST CONFIGURATION

**APPENDIX B**

PHOTOS OF EUT

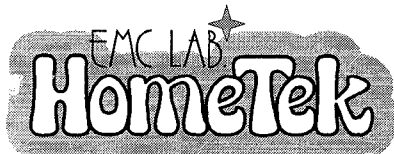

HomeTek Technology Inc.

ADDRESS: No. 67-9, Shir Men Road, Tu Cheng City,  
Taipei Hsien, Taiwan  
PHONE : 886-2-22608375 FAX : 886-2-22748013  
E - mail : hometek@ms15.hinet.net

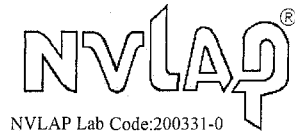

# CERTIFICATE

APPLICANT : Smart Home Engineering Corp.  
ADDRESS : 10F, No. 493, Chung-Cheng Rd.,  
Hsin Tien City, Taipei 231, Taiwan, R. O. C.  
Receipt Date : 11/08/2007 Final Test Date: 12/05/2007  
EUT : CAT5 Distributor & Extender  
MODEL NO. : VE0XXRX

## MEASUREMENT PROCEDURE USED :

AS/NZS CISPR 22: 2006 Information technology equipment – Radio  
disturbance characteristics – Limits and methods of measurement

- THE MAXIMUM EMISSION LEVELS WERE COMPARED TO THE CISPR 22 CLASS B LIMITS BOTH RADIATED AND CONDUCTED EMISSION.
- THE ABOVE DEVICE WAS TESTED BY HOMETEK TECHNOLOGY INC. TO SHOWS THE MAXIMUM EMISSION LEVEL FROM THE DEVICE.
- THIS TEST RESULTS OF THIS REPORT APPLIES TO ABOVE TESTED SAMPLE ONLY.
- THIS TEST REPORT SHALL NOT BE REPRODUCE IN PART WITHOUT WRITTEN APPROVAL OF HOMETEK TECHNOLOGY INC.
- THE REPORT MUST NOT BE USED BY THE CLIENT TO CLAIM PRODUCT ENDORSEMENT BY NVLAP, NIST OR ANY AGENCY OF THE U. S. GOVERNMENT.
- THE TEST RESULTS ARE TRACEABLE TO THE NATIONAL OR INTERNATIONAL STANDARD.

APPROVED BY :

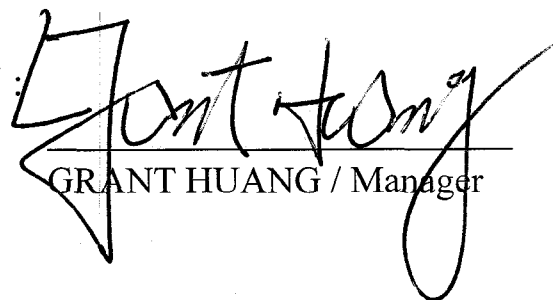
  
GRANT HUANG / Manager

## GENERAL INFORMATION

- 1 APPLICANT : Smart Home Engineering Corp.
- 2 ADDRESS : 10F., No. 493, Chung-Cheng Rd.,  
Hsin-Tien City, Taipei 231, Taiwan, R. O. C.
- 3 MANUFACTURER : Smart Home Engineering Corp.
- 4 ADDRESS : 10F., No. 493, Chung-Cheng Rd.,  
Hsin-Tien City, Taipei 231, Taiwan, R. O. C.
- 5 DESCRIPTION OF EUT :
- EUT : CAT5 Distributor & Extender
- Model Number : VE0XXRX
- Serial # : N/A

5.1 The difference between series of models VE0XXRX are as shown below:

- (1) The first “X” represents different system input.
- (2) The second “X” represent different accessory.
- (3) The third “X” represent different color.

The PCB layout is similar. The worst case of EMI test data were shown in this test report.

6 FEATURES OF EUT :

Support Resolution	Up to 1600 x1200 @ 85Hz
Transmission Distance	Up to 1000 ft. (300 m)
Video Amplifier Bandwidth	Local : 750MHz    Remote : 350MHz
Video input Signals	RGB Analog (75 $\Omega$ , 0.7VP-P)
	Sync Signal H/V Separated (TTL)
Horizontal Frequency Range	30-95KHz
Vertical Frequency Range	50-180Hz
VGA Connector	15-pin Mini D-Sub (High Density)
Link Connector	1 x RJ-46
Power Supply	5V DC 1200mA
Power consumption	500 mA (Max)
Temperature	Operation: 0 to 55°C, Storage: -20 TO 85°C, Humidity: up to 95%
Dimensions      W x H x D mm	145 x 96 x 37

7 TEST MODE :

The EUT were investigated with three resolution modes shown as below :

- (1) 800 x 600 Mode
- (2) 1024 x 768 Mode
- (3) 1600 x 1200 Mode

The test mode of (3) 1600 x 1200 Mode is worst case, and the final test data were shown in this test report.



## **MODIFICATION LIST**

THE FOLLOWING ACCESSORIES WERE ADDED TO THE EUT DURING TESTING :

NO MODIFICATION BY HOMETEK TECHNOLOGY INC.

## CONDUCTED POWER LINE TEST

### 1 TEST INSTRUMENTS & FACILITIES

The following test Instruments was used during the conducted test :

Item	Instruments/ Facilities	Specification	Manufacturer	Model #	Date Of Cal.
1	EMI Receiver	9KHz ~ 30MHz	ROHDE & SCHWARZ	ESHS10 840449/001	DEC/2006
2	LISN (for EUT)	50Ω/50uH/16A 9KHz ~ 30MHz	AFJ	LT32 32039930056	DEC/2006
3	LISN (for Support Unit)	50Ω/50uH/15A 150KHz ~ 30MHz	SANKI	LISN1-15V 080404E	DEC/2006
4	Terminator	50Ω	N/A	N/A	DEC/2006
5	Attenuation	50Ω/10dB	Mini-Circuit	NAT-10 AT-002	DEC/2006
6	Cable	5.4m	SUHNER	RG-223 CON2-001	DEC/2006
7	ESXS-K1 (software)	Version 2.03b 9KHz ~ 30MHz	ROHDE & SCHWARZ	1082.9678.02 840.913/246	N/A

Note : Items 1 ~ 6 were calibrated within period of 1 year.

### 2 TEST PROCEDURE

- 2.1 The EUT was tested according to **AS/NZS CISPR 22**.
- 2.2 The EUT was placed 0.4 meter from the conducting wall of shielding room and kept at least 0.8 meter from any other grounded conducting surface.
- 2.3 The frequency range form 0.15 MHz to 30 MHz was investigated.
- 2.4 The LISN used was 50 Ohm / 50 uHenry as specified of **AS/NZS CISPR 22**.
- 2.5 All the support peripherals are connect to the other LISN.
- 2.6 Cables and peripherals were moved to find the maximum emission levels for each frequency.

### 3 TEST SETUP

#### 3.1 Typical : Setup Of Conducted Test

ELECTRICAL AND ELECTRONIC EQUIPMENT IN THE RANGE OF 9kHz TO 40 GHz AS/NZS CISPR 22

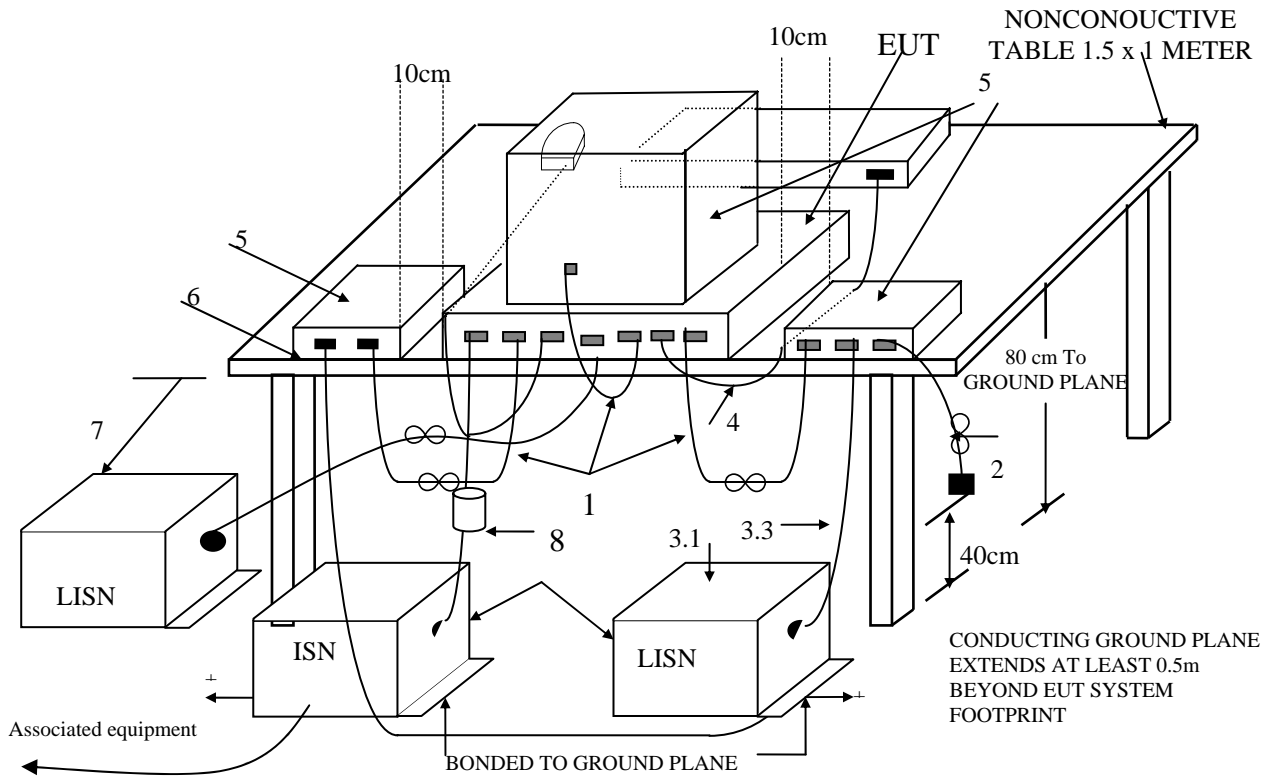

+LISNs may have to be moved to the side to meet 3.3 below.

(Details for setup configuration, please refer to appendix A.)

#### LEGEND:

1. If cables, which hang closer than 40 cm to the horizontal metal groundplane, cannot be shortened to appropriate length, the excess shall be folded back and forth forming a bundle 30 cm to 40 cm long.
2. Excess mains cord shall be bundled in the centre or shortened to appropriate length.
3. EUT is connected to one artificial mains network (AMN). All AMNs and ISNs may alternatively be connected to a vertical reference plane or metal wall.
  - 3.1 All other units of a system are powered from a second AMN. A multiple outlet strip can be used for multiple mains cords.
  - 3.2 AMN and ISN are 80 cm from the EUT and at least 80 cm from other units and other metal planes.
  - 3.3 Mains cords and signal cables shall be positioned for their entire lengths, as far as possible, at 40 cm from the vertical reference plane.
4. Cables of hand-operated devices, such as keyboards, mice, etc., have to be placed as close as for normal usage.
5. Peripherals shall be placed at a distance of 10 cm from each other and from the controller, except for the monitor which, if this is an acceptable installation practice, shall be placed directly on the top of the controller.
6. I/O signal cable intended for external connection.
7. The end of the I/O signal cables which are not connected to an AE may be terminated, if required, using correct terminating impedance.
8. If used, the current probe shall be placed at 0.1 m from the ISN.

#### Test Configuration Tabletop Equipment Conducted Emission

## 3.2 Block Diagram Of Conducted Test

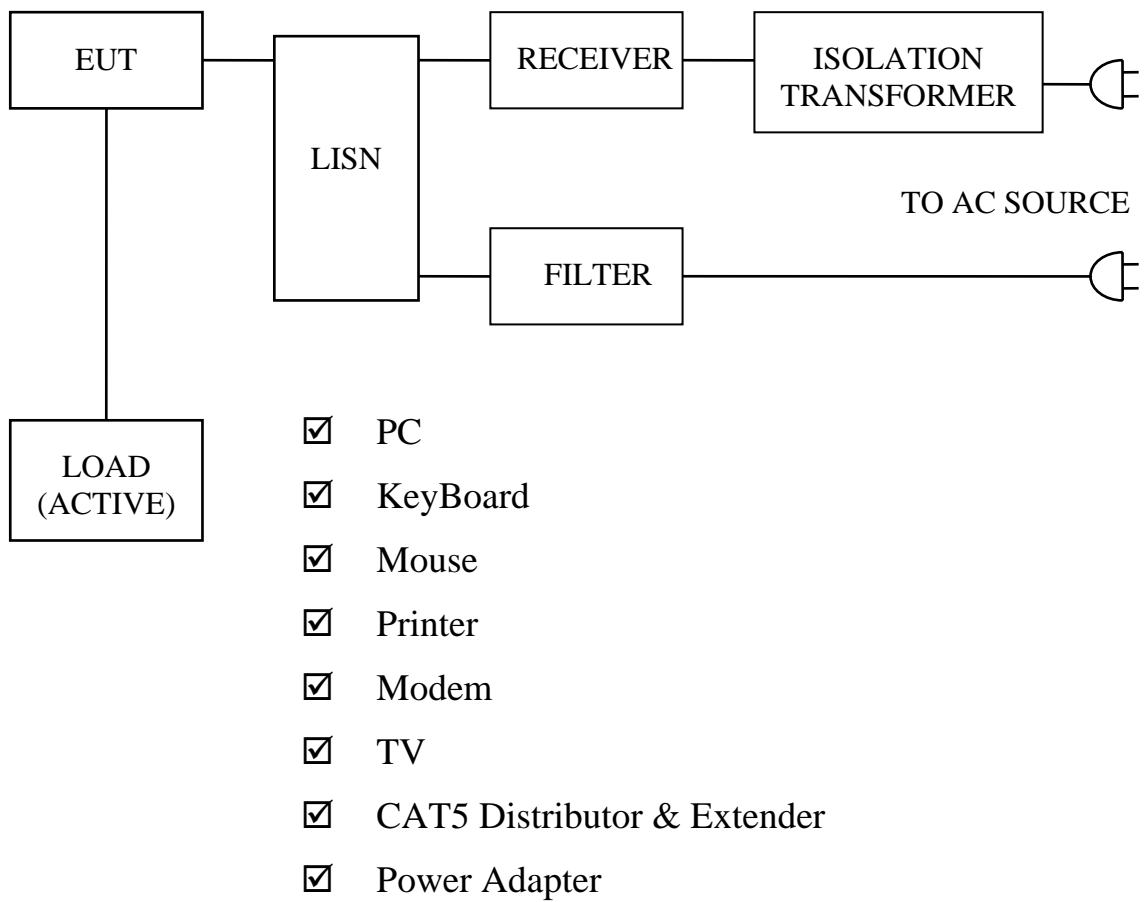

#### 4 CONFIGURATION OF THE EUT

The EUT was configured according to **AS/NZS CISPR 22**. All I/O ports were connected to the appropriate peripherals. All peripherals and cables are listed below (including internal device) :

##### 4.1 EUT

EUT Type	: <input type="checkbox"/> Proto Type <input checked="" type="checkbox"/> Engineer Type <input type="checkbox"/> Mass Production
Condition when received	: <input checked="" type="checkbox"/> Good <input type="checkbox"/> Damage : _____
Device	: CAT5 Distributor & Extender
Applicant	: Smart Home Engineering Corp.
Manufacturer	: Smart Home Engineering Corp.
Model Number	: VE0XXRX
Serial Number	: N/A
FCC ID	: N/A
VGA OUT Port	: Metal Type Connector
VGA Cable	: Shielded, 1.8 m, Metal Type Connector
Audio Cable	: Un-Shielded, 1.9 m
REMOTE Port Cable	: Shielded, 0.8 m
Power Cord (AC)	: N/A
Power Cord (DC)	: Un-Shielded, 1.75 m
Power Supply Type	: Switching Power Adapter

## 4.2 PERIPHERALS

### Host Personal Computer

Manufacturer : DELL  
Model Number : DMC  
Power Cord : Un-Shielded ,3pin,1.5m  
Power Supply Type : Switching  
Serial Number : JMM5L 1X  
FCC ID : FCC DoC

### KeyBoard

Manufacturer : DELL  
Model Number : SK-8115  
Serial Number : N/A  
FCC ID : FCC DoC  
Data Cable : Shielded,1.5 m,Connected to the USB port  
Power Cord : N/A

### Mouse

Manufacturer : DELL  
Model Number : M056UOA  
Serial Number : F1A01NWF  
FCC ID : FCC DoC  
Data Cable : Shielded,1.5 m,Connected to the USB port  
Power Cord : N/A



Printer

Manufacturer : EPSON  
Model Number : P310B  
Serial Number : N/A  
FCC ID : FCC DoC  
Data Cable : Shielded, 1.5 m, Connected to the Printer port  
Power Cord & Adaptor : Un-Shielded, 1.8 m

Modem

Manufacturer : ACEEX  
Model Number : 1414  
Serial Number : N/A  
FCC ID : IFAXDM1414  
Data Cable : Shielded, 1.5 m, Connected to the COM port  
Power Cord & Adaptor : Un-Shielded, 1.8 m

TV

Manufacturer : SAMSUNG  
Model Number : LA26R51B  
Serial Number : N/A  
FCC ID : FCC DoC  
Power Cord : Un-Shielded, 1.5 m



CAT5 Distributor & Extender

Manufacturer : Smart Home Engineering Corp.

Model Number : VE05AT

Power Adapter

Manufacturer : ELEC

Model Number : ADP051200R-2

Serial Number : N/A

FCC ID : N/A

Data Cable : N/A

Power Cord (DC) : Un-Shielded, 1.75 m

4.3 REMARK : N/A

## 5 EUT OPERATING CONDITION

- 5.1 The frequency of the EUT is none.
- 5.2 Configure the EUT according to the **AS/NZS CISPR 22**.
- 5.3 The test configuration included PC, TV, Keyboard, Mouse, Printer, Modem, CAT5 Distributor & Extender and Adapter.
- 5.4 Turn on all the power of EUT and peripheral.
- 5.5 PC sends data signal (resolutions: 800 x 600 / 1024 x 768 / 1600x 1200) to TV via EUT's VGA port.
- 5.6 During the test, the PC sends "H" patterns to each I/O port individually. EUT display "H" character.
- 5.7 Adjust the location of EUT and peripheral to gain the maximum EMI noise.
- 5.8 The photos of conducted test configuration, please refer to appendix A.**

## 6 LIMIT OF CONDUCTED POWER LINE EMISSION CLASS B

### AS/NZS CISPR 22

Frequency Range	Quasi Peak	Average
0.15 ~ 0.5 MHz	66 - 56 dBuV	56 - 46 dBuV
0.5 ~ 5 MHz	56 dBuV	46 dBuV
5 ~ 30 MHz	60 dBuV	50 dBuV

- 6.1 In the above table, the tighter limit applies at the band edges.

## 7 RESULT OF CONDUCTED POWER LINE TEST

- 7.1 The frequency range from 0.15 MHz to 30 MHz was investigated. All readings are quasi-peak values and average.
- 7.2 IF bandwidth : 9 kHz, Meas Time : 1 sec.
- 7.3 Temperature : 25.1 °C, Humidity : 48 % RH.
- 7.4 Uncertainty in conducted emission measurement : ± 2.90dB.
- 7.5 The conducted test result were gained by following procedures :  
 Level = Reading Level + Insertion Loss of LISN + Cable Loss  
 (All calculation were done by ESHS10 EMI test receiver.)
- 7.6 Result : **PASSED**

### 8 CONDUCTED POWER LINE TEST DATA (PAGE 1)

HomeTek EMC LAB. TEL :86-769-85303005 , 886-2-22608375

05 Dec 2007 16:34

#### CONDUCTED EMISSIONS

EUT: VE02AR  
 Manuf: 6K017  
 Op Cond: LINE  
 Operator: CH  
 Test Spec: FOR AS/NZS CISPR22 CLASS B  
 Comment: 240V/50Hz  
 1600 x 1200 MODE  
 Result File: 6K0170031.dat :

Prescan Measurement: Detectors: X PK / + AV  
 Meas Time: see scan settings  
 Subranges: 8  
 Acc Margin: 55 dB

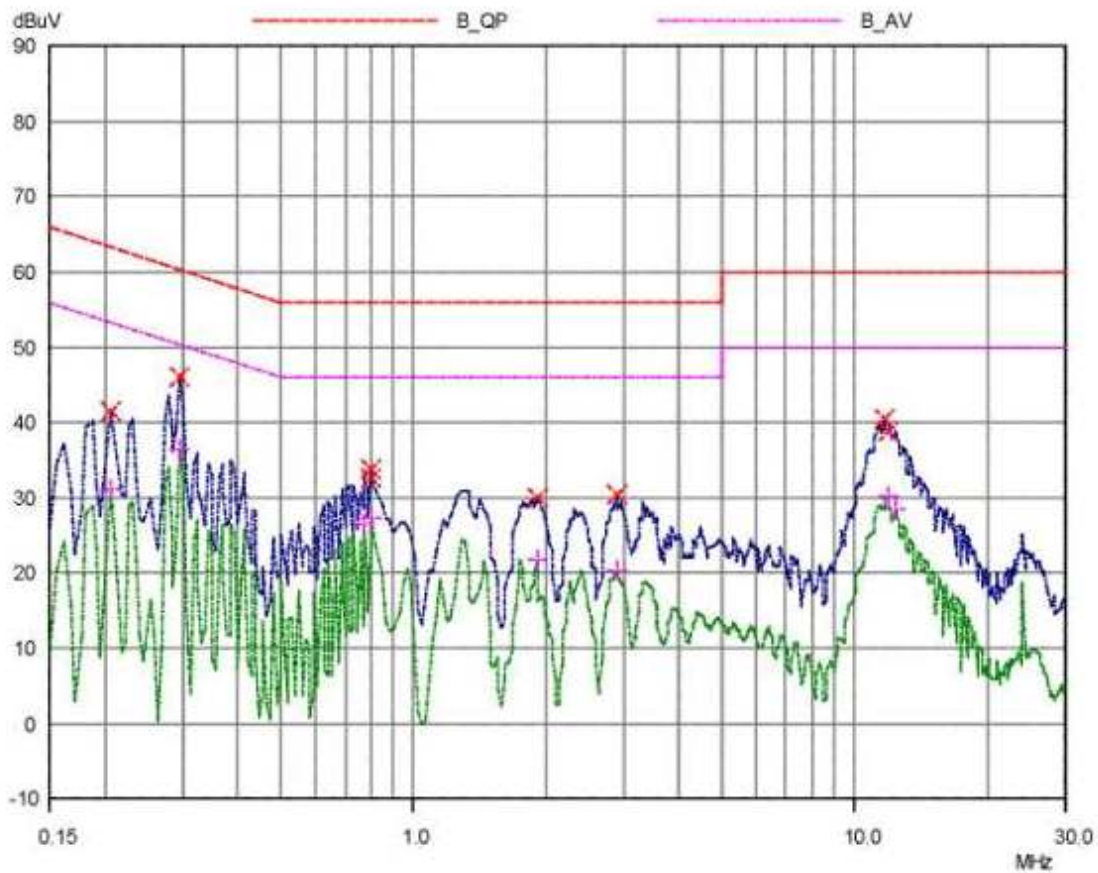



### 9 CONDUCTED POWER LINE TEST DATA (PAGE 2)

HomeTek EMC LAB. TEL :86-769-5303005 , 886-2-22608375

05 Dec 2007 16:34

#### CONDUCTED EMISSIONS

EUT: VE02AR  
 Manuf: 6K017  
 Op Cond: LINE  
 Operator: CH  
 Test Spec: FOR AS/NZS CISPR22 CLASS B  
 Comment: 240V/50Hz  
 1600 x 1200 MODE  
 Result File: 6K0170031.dat

Prescan Measurement: Detectors: X PK / + AV  
 Meas Time: see scan settings  
 Subranges: 8  
 Acc Margin: 55 dB

#### Peak Search Results

Frequency MHz	PK Level dBuV	PK Limit dBuV	PK Delta dB
0.205	41.48	63.41	21.93
0.295	46.11	60.38	14.27
0.7945	33.90	56.00	22.10
0.8	32.70	56.00	23.30
1.9	30.02	56.00	25.98
2.88	30.47	56.00	25.53
11.76	40.55	60.00	19.45
12.0	38.88	60.00	21.12

Frequency MHz	AV Level dBuV	AV Limit dBuV	AV Delta dB
0.205	31.09	53.41	22.32
0.295	36.49	50.38	13.89
0.775	26.59	46.00	19.41
0.8	27.42	46.00	18.58
1.9	21.86	46.00	24.14
2.86	20.40	46.00	25.60
11.8	30.18	50.00	19.82
12.36	28.47	50.00	21.53

\* limit exceeded

### 10 CONDUCTED POWER LINE TEST DATA (PAGE 3)

HomeTek EMC LAB. TEL :86-769-85303005 , 886-2-22608375

05 Dec 2007 16:11

#### CONDUCTED EMISSIONS

EUT: VE02AR  
 Manuf: 6K017  
 Op Cond: NEUTRAL  
 Operator: CH  
 Test Spec: FOR AS/NZS CISPR22 CLASS B  
 Comment: 240V/50Hz  
 1600 x 1200 MODE  
 Result File: 6K0170031.dat

Prescan Measurement: Detectors: X PK / + AV  
 Meas Time: see scan settings  
 Subranges: 8  
 Acc Margin: 55 dB

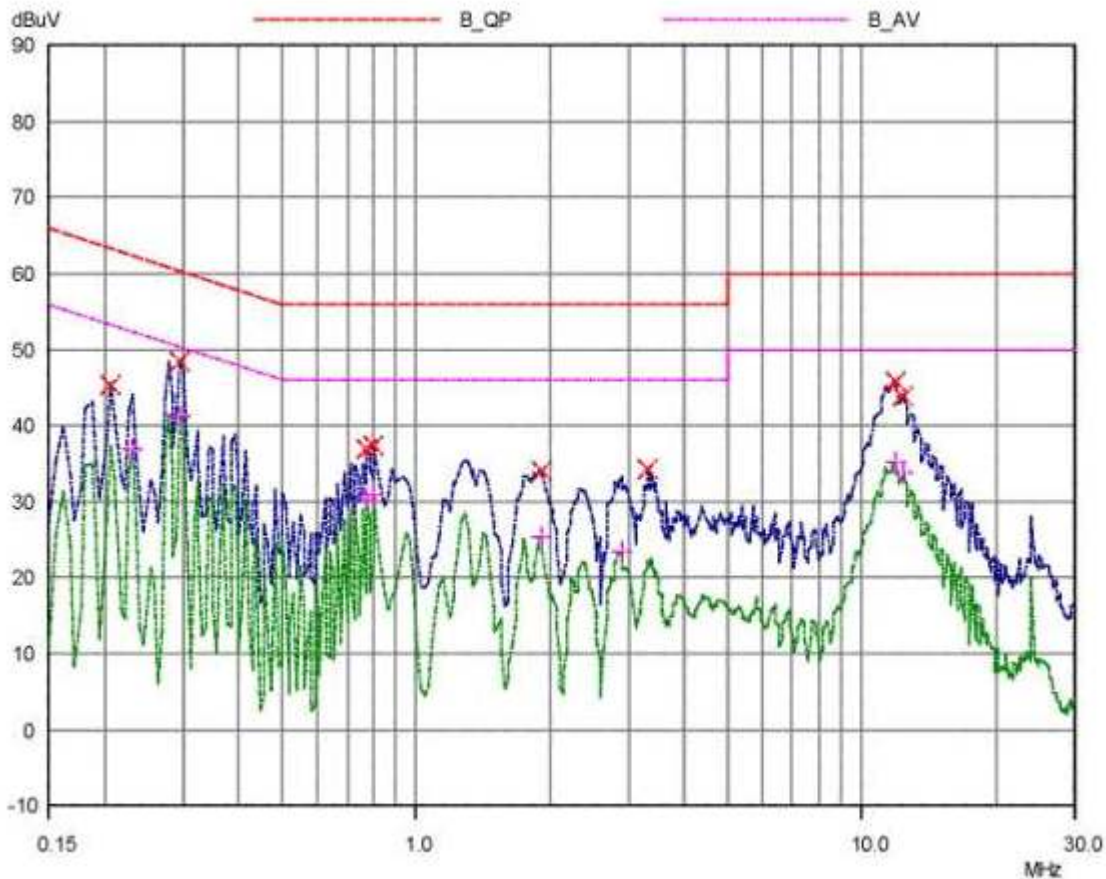



### 11 CONDUCTED POWER LINE TEST DATA (PAGE 4)

HomeTek EMC LAB. TEL :86-769-85303005 , 886-2-22608375

05 Dec 2007 16:11

#### CONDUCTED EMISSIONS

EUT: VE02AR  
 Manuf: 6K017  
 Op Cond: NEUTRAL  
 Operator: CH  
 Test Spec: FOR AS/NZS CISPR22 CLASS B  
 Comment: 240V/50Hz  
 1600 x 1200 MODE  
 Result File: 6K0170031.dat :

Prescan Measurement:      Detectors:      X PK / + AV  
                                  Meas Time:      see scan settings  
                                  Subranges:      8  
                                  Acc Margin:     55 dB

#### Peak Search Results

Frequency MHz	PK Level dBuV	PK Limit dBuV	PK Delta dB
0.205	45.30	63.41	18.11
0.295	48.48	60.38	11.90
0.775	36.89	56.00	19.11
0.8	37.49	56.00	18.51
1.9	33.95	56.00	22.05
3.32	34.35	56.00	21.65
11.84	45.87	60.00	14.13
12.3	44.02	60.00	15.98

Frequency MHz	AV Level dBuV	AV Limit dBuV	AV Delta dB
0.23	36.87	52.45	15.58
0.295	41.15	50.38	9.23
0.775	30.38	46.00	15.62
0.8	30.95	46.00	15.05
1.9	25.47	46.00	20.53
2.86	23.39	46.00	22.61
11.8	35.27	50.00	14.73
12.36	33.80	50.00	16.20

\* limit exceeded

## RADIATED EMISSION TEST

### 1 TEST INSTRUMENTS & FACILITIES

The following test Instruments was used during the radiated emission test :

Item	Instruments /facilities	Specification	Manufacturer	Model # / S/N#	Date of Cal.
1	OPEN AREA TEST SITE	<input checked="" type="checkbox"/> OATS 3	HomeTek	N/A	DEC/2006
2	EMI TEST RECEIVER	20Hz ~ 5GHz	ROHED& SCHWARZ	ESBI 845636/007	DEC/2006
3	PRE-AMPLIFIER	9KHz ~1300MHz	HEWLETT PACKARD	8447D 1937A02095	DEC/2006
4	ANTENNA (BI-LOG)	30MHz ~ 2GHz	ANTENNA RESEACH	LPB2520/A 1095	MAR/2007
5	Attenuation	50Ω/6dB	JYE BAO	FAT-N(M-F) 001	DEC/2006
6	Cable	10m	SUHNER	RG214/U OS3-003	DEC/2006
7	Cable	14m	BELDEN	9913 OS3-001	DEC/2006
8	EMI 32 (software)	N/A	AUDIX	19991013-0923	N/A

Note : Items 1 ~ 7 were calibrated within period of 1 year.

## 2 TEST PROCEDURE

- 2.1 The EUT was test according to **AS/NZS CISPR 22**.
- 2.2 The radiated test was performed at HomeTek Lab's Open Site 3.
- 2.3 The frequency range from 30 MHz to 1 GHz, the measurement were made at 10 meters, with a BI-log antenna.

## 3 TEST SETUP

### 3.1 TEST SETUP OF OPEN SITE.

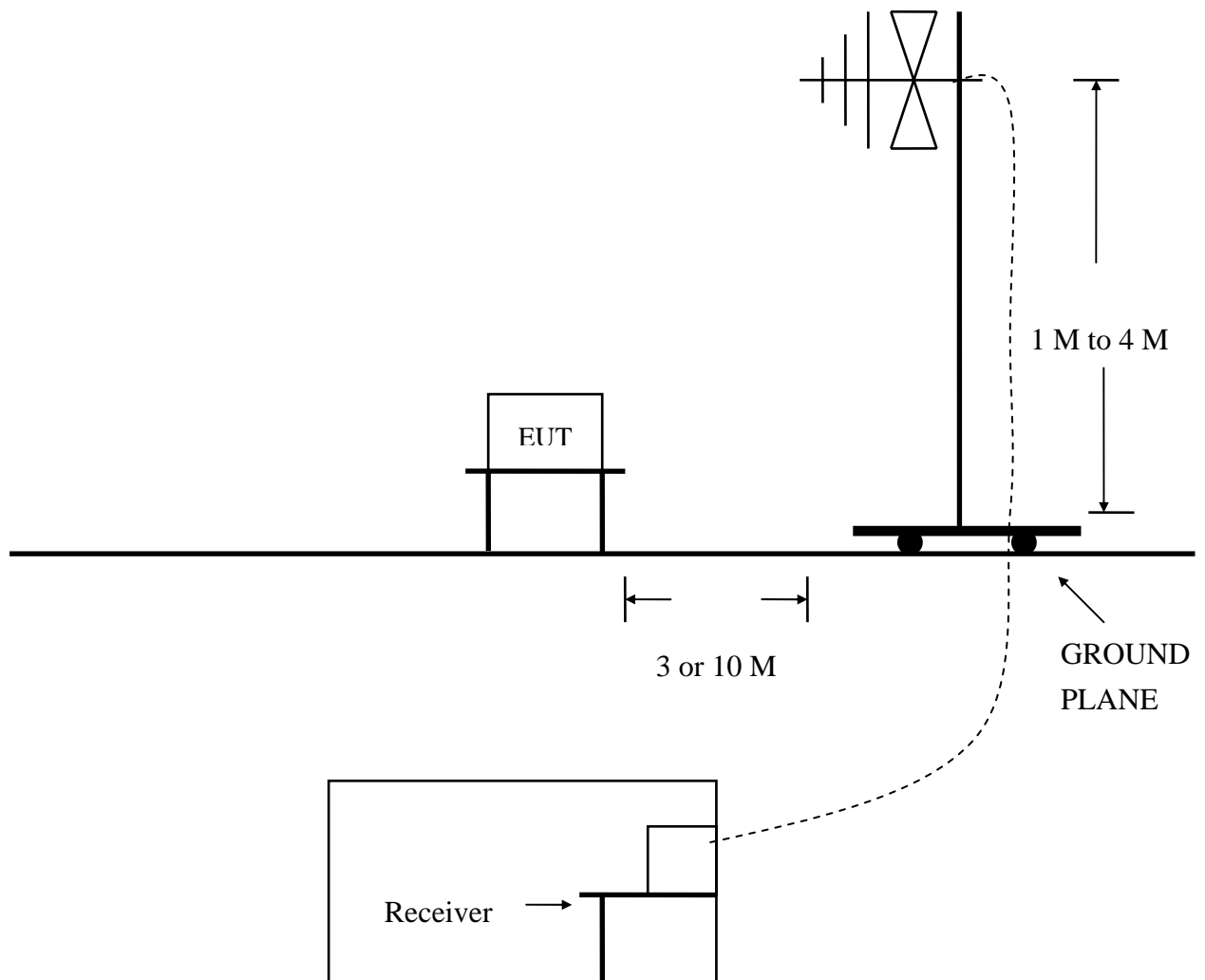

### 3.2 TEST SETUP OF EUT

ELECTRICAL AND ELECTRONIC EQUIPMENT IN THE RANGE OF 9kHz TO 40 GHz AS  
NZS CISPR 22

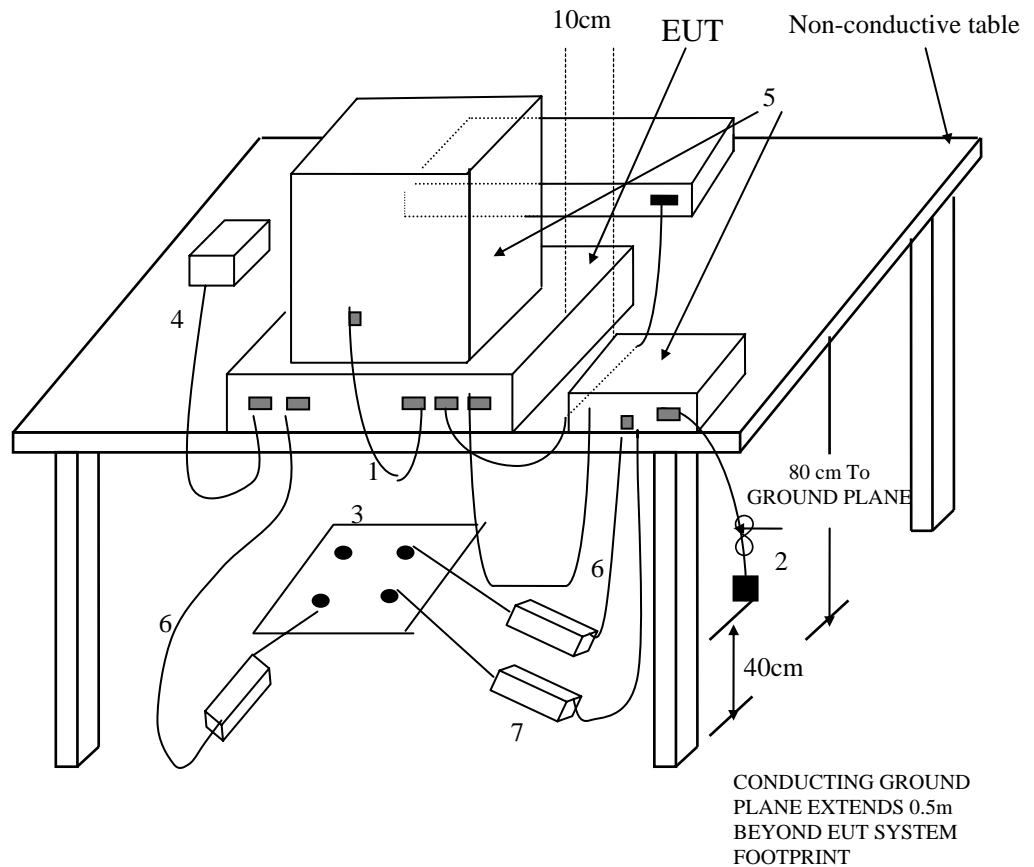

(Details for setup configuration, please refer to appendix A.)

#### LEGEND:

1. If cables, which hang closer than 40 cm to the horizontal metal ground plane cannot be shortened to the appropriate length, the excess shall be folded back and forth forming a bundle 30 cm to 40 cm long.
2. The end of I/O signal cables which are not connected to a peripheral may be terminated, if required for proper operation using correct terminating impedance.
3. Mains junction box(es) shall be flush with, and bonded directly to, the metal ground plane.  
NOTE if used, the AMN shall be installed under the horizontal metal ground plane.
4. Cables of hand-operated devices such as keyboards, mouses, etc. shall be placed as for normal usage.
5. Peripherals shall be placed at a distance of 10 cm from each other and from the controller, except for the monitor which, if for an acceptable installation practice, shall be placed directly on top of the controller.
6. Mains cables, telephone lines or other connections to auxiliary equipment located outside the test area shall drape to the floor, be fitted with ferrite clamps or ferrite tubes placed on the floor at the point where the cable reaches the floor and then routed to the place where they leave the turntable. No extension cords shall be used to mains receptacle.
7. Ferrite clamps or ferrite tubes with similar characteristics (as defined in 10.4). No more than one cable per clamp.

#### Test Configuration Tabletop Equipment Radiated Emission

4 CONFIGURATION OF THE EUT

Same as “Conducted Power Line test”, section 5

5 EUT OPERATING CONDITION

5.1 Same as “Conducted Power Line test”, section 5

5.2 The radiated emission in the frequency range from 30 MHz - 1000 MHz was test in a horizontal and vertical polarization at HomeTek Lab’s open site 3.

**5.3 The photos of radiated test configuration, please refer to appendix A.**

6 LIMIT OF RADIATED EMISSION CLASS B

AS/NZS CISPR 22

Frequency (MHz)	Measurement Distance	Limit (dBuV/m)
30 - 230	10 (M)	30
230 - 1000	10 (M)	37

6.1 The tighter limit shall apply at the edge between two frequency bands.

6.2 Measurement distance in meters between the measuring instrument antenna and the closed point of any part of the EUT or peripherals.

7 RESULT OF RADIATED EMISSION TEST

7.1 The frequency range from 30 MHz to 1 GHz was investigated.

7.2 All readings below or equal 1 GHz are quasi-peak or peak values with resolution bandwidth of 120 KHz.

7.3 The measurements were made at 10 meters of HomeTek Lab’s open site 3.

7.4 Temperature : 24.7 °C, Humidity : 49 % RH.

7.5 Uncertainty in radiated emission measurement : ± 4.18dB.

7.6 The radiated emission result were gained by the following method :

Level = Reading Level + Probe Factor (Antenna Factor) + Cable Loss – Preamp Factor

Over Limit = Level – Limit Line

7.7 Result : **PASSED**

8 RADIATED EMISSION TEST DATA (PAGE 1)



HomeTek Technology Inc.

HomeTek Technology Inc.  
Tel:02-22608375  
Fax:02-22748013

Data#: 1 File#: 6K017.EMI

Date: 2007-12-05 Time: 11:18:51

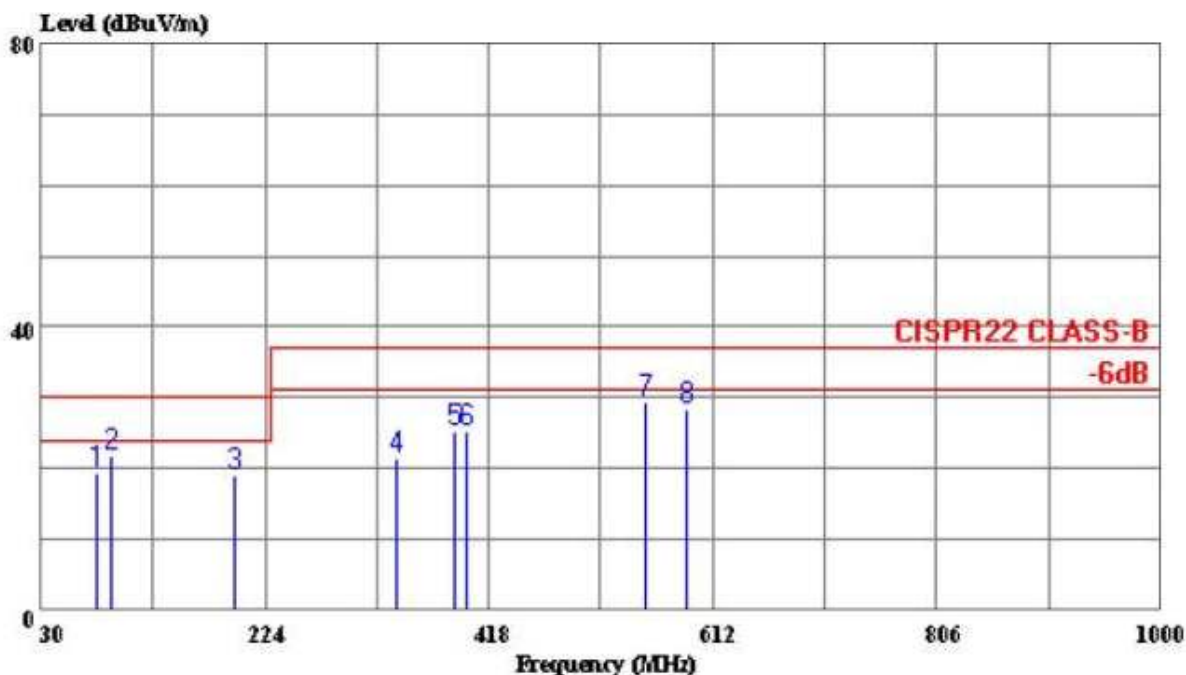

Trace:

Ref Trace:

Condition: CISPR22 CLASS-B 10m LPB-250/A-031028 HORIZONTAL  
 out : VE02AR  
 power: 240V/50Hz  
 memo : 1600 x 1200 MODE

Page: 1

	Freq	Level	Limit	Over	Read		Remark
	MHz	dBuV/m	dBuV/m	Limit	Level	Factor	
				dB	dBuV	dB	
1	78.500	19.33	30.00	-10.67	37.90	-18.57	QP
2	91.110	21.87	30.00	-8.14	38.80	-16.94	QP
3	196.840	19.04	30.00	-10.96	38.80	-19.76	Peak
4	337.490	21.53	37.00	-15.47	33.10	-11.57	Peak
5	387.930	25.34	37.00	-11.66	34.90	-9.56	Peak
6	399.570	25.14	37.00	-11.86	36.10	-10.96	Peak
7	554.770	29.55	37.00	-7.45	35.90	-6.35	Peak
8	589.690	28.46	37.00	-8.54	34.90	-6.44	Peak

9 RADIATED EMISSION TEST DATA (PAGE 2)



HomeTek Technology Inc.

HomeTek Technology Inc.  
 Tel:02-22608375  
 Fax:02-22748013

Data#: 2 File#: 6K017.EMI Date: 2007-12-05 Time: 12:11:16

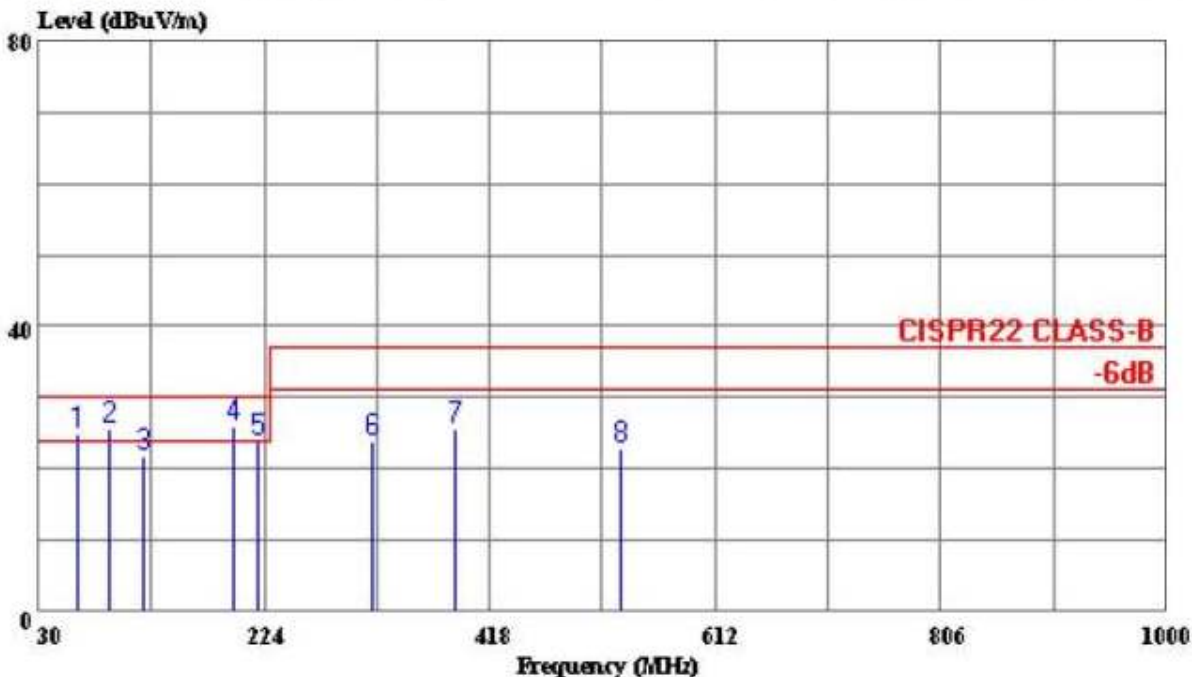

Trace:

Ref Trace:

Condition: CISPR22 CLASS-B 10m LPB-250/A-031028 VERTICAL  
 out : VE02AR  
 power: 240V/50Hz  
 memo : 1600 X 1200 MODE

Page: 1

	Freq	Level	Limit	Over	Read		
	MHz	dBuV/m	dBuV/m	dB	dBuV	dB	Remark
1	62.980	24.80	30.00	-5.20	41.10	-16.30	Peak
2	91.110	25.54	30.00	-4.46	41.60	-16.06	QP
3	119.240	21.89	30.00	-8.11	39.80	-17.91	QP
4	196.840	26.06	30.00	-3.94	43.80	-17.74	QP
5	218.180	23.94	30.00	-6.06	37.00	-13.06	Peak
6	316.150	23.84	37.00	-13.16	30.70	-6.86	Peak
7	387.930	25.70	37.00	-11.30	35.90	-10.20	Peak
8	531.490	22.98	37.00	-14.02	33.10	-10.12	Peak



HomeTek Technology Inc.

## **Appendix A**

# **PHOTOS OF TEST CONFIGURATION**

**PHOTO OF CONDUCTED POWER LINE TEST**



**Front View**

**PHOTO OF RADIATED EMISSION TEST**



**Front View**



HomeTek Technology Inc.

## **Appendix B**

### **PHOTOS OF EUT**

## PHOTO OF EUT



**Front View of EUT**



**Rear View of EUT**



**Inside View of EUT**



**Full View of Adapter**

# Declaration of Conformity

Responsible Party Name :

Address :

Phone No :

Fax No :

Declares under our sole responsibility that the product

Product Name : CAT5 Distributor & Extender

Model No. : VE0XXRX

to which this declaration relates is in conformity with the following standards or other normative documents

AS/NZS CISPR 22 (2006) : Electromagnetic Interference  
– Limits and Methods of Measurement of Information Technology Equipment

Representative Person's Name : \_\_\_\_\_

Signature : \_\_\_\_\_

Date : \_\_\_\_\_



**UNITED STATES DEPARTMENT OF COMMERCE**  
**National Institute of Standards and Technology**  
Gaithersburg, Maryland 20899

October 3, 2007

Mr. Grant Huang  
HomeTek Technology Inc.  
P.O Box: 13-131, Pan-Chiao City  
No. 67-9 Shir Men Rd., Tu Chen City  
Taipei Shien 236  
TAIWAN

NVLAP Lab Code: 200331-0

Dear Mr. Huang:

I am pleased to inform you that continuing accreditation for specific test methods in EC&T : Electromagnetic Compatibility & Telecommunications is granted to your organization under the National Voluntary Laboratory Accreditation Program (NVLAP). This accreditation is effective until September 30, 2008, provided that your organization continues to comply with accreditation requirements contained in the NVLAP Procedures.

Your Certificate of Accreditation is enclosed along with a statement of your Scope of Accreditation. You may reproduce these documents in their entirety and announce your organization's accreditation status using the NVLAP logo in business publications, the trade press, and other business-oriented literature. Accreditation does not relieve your organization from observing and complying with any applicable existing laws and/or regulations.

We are pleased to have you participate in NVLAP and look forward to your continued association with this program. If you have any questions concerning your NVLAP accreditation, please direct them to Kurt B. Fischer, Sr. Program Manager, Laboratory Accreditation Program, National Institute of Standards and Technology, 100 Bureau Dr. Stop 2140, Gaithersburg, MD 20899-2140; (301) 975-4016.

Sincerely,

Sally S. Bruce, Chief  
Laboratory Accreditation Program

Enclosure(s)





**SCOPE OF ACCREDITATION TO ISO/IEC 17025:2005**

**HomeTek Technology Inc.**

P.O Box: 13-131, Pan-Chiao City  
No. 67-9 Shir Men Rd., Tu Chen City  
Taipei Shien 236  
TAIWAN

Mr. Grant Huang

Phone: 886-2-22608375 Fax: 886-2-22748013

E-Mail: hometek@ms15.hinet.net

**ELECTROMAGNETIC COMPATIBILITY  
AND TELECOMMUNICATIONS**

**NVLAP LAB CODE 200331-0**

***NVLAP Code Designation / Description***

**Emissions Test Methods:**

12/CIS14a	EN 55014-1 (1993), A1 (1997), A2 (1999):
12/CIS14a2	BS EN 55014-1 (2001) with A1 and A2: Electromagnetic compatibility - Requirements for household appliances, electric tools and similar apparatus - Part 1: Emission
12/CIS14b1	AS/NZS CISPR 14-1 (2003): Electromagnetic Compatibility - Requirements for household appliances, electric tools and similar apparatus - Part 1: Emission
12/CIS14c	CNS 13783-1: Electromagnetic Compatibility Requirements for household appliances, electric tools and similar apparatus - Part 1: Emissions
12/CIS14d	IEC/CISPR 14-1 (2001) and A1 (2001): Electromagnetic Compatibility - Requirements for household appliances, electric tools and similar apparatus - Part 1: Emissions
12/CIS14x	IEC/CISPR 14-1, Ed. 4 (2003): Electromagnetic Compatibility - Requirements for household appliances, electric tools and similar apparatus - Part 1: Emission
12/CIS22	IEC/CISPR 22 (1997) & EN 55022 (1998) + A1(2000): Limits and methods of measurement of radio disturbance characteristics of information technology equipment

2007-10-01 through 2008-09-30

*Effective dates*

For the National Institute of Standards and Technology



**ELECTROMAGNETIC COMPATIBILITY  
AND TELECOMMUNICATIONS**

**NVLAP LAB CODE 200331-0**

<i>NVLAP Code</i>	<i>Designation / Description</i>
12/CIS22a	IEC/CISPR 22 (1993) and EN 55022 (1994): Limits and methods of measurement of radio disturbance characteristics of information technology equipment, Amendment 1 (1995) and Amendment 2 (1996)
12/CIS22b	CNS 13438 (1997): Limits and Methods of Measurement of Radio Interference Characteristics of Information Technology Equipment
12/CIS22c	IEC/CISPR 22, Fourth Edition (2003-04) & EN 55022 (1998): Information technology equipment - Radio disturbance characteristics - Limits and methods of measurement
12/FCC15b	ANSI C63.4 (2003) with FCC Method 47 CFR Part 15, Subpart B: Unintentional Radiators
12/T51a	AS/NZS CISPR 22 (2004): Information technology equipment - Radio disturbance characteristics - Limits and methods of measurement
12/VCCIa	VCCI: Agreement of Voluntary Control Council for Interference by Information Technology Equipment - Technical Requirements: V-3/2005.04

2007-10-01 through 2008-09-30

*Effective dates*

*For the National Institute of Standards and Technology*

United States Department of Commerce  
National Institute of Standards and Technology

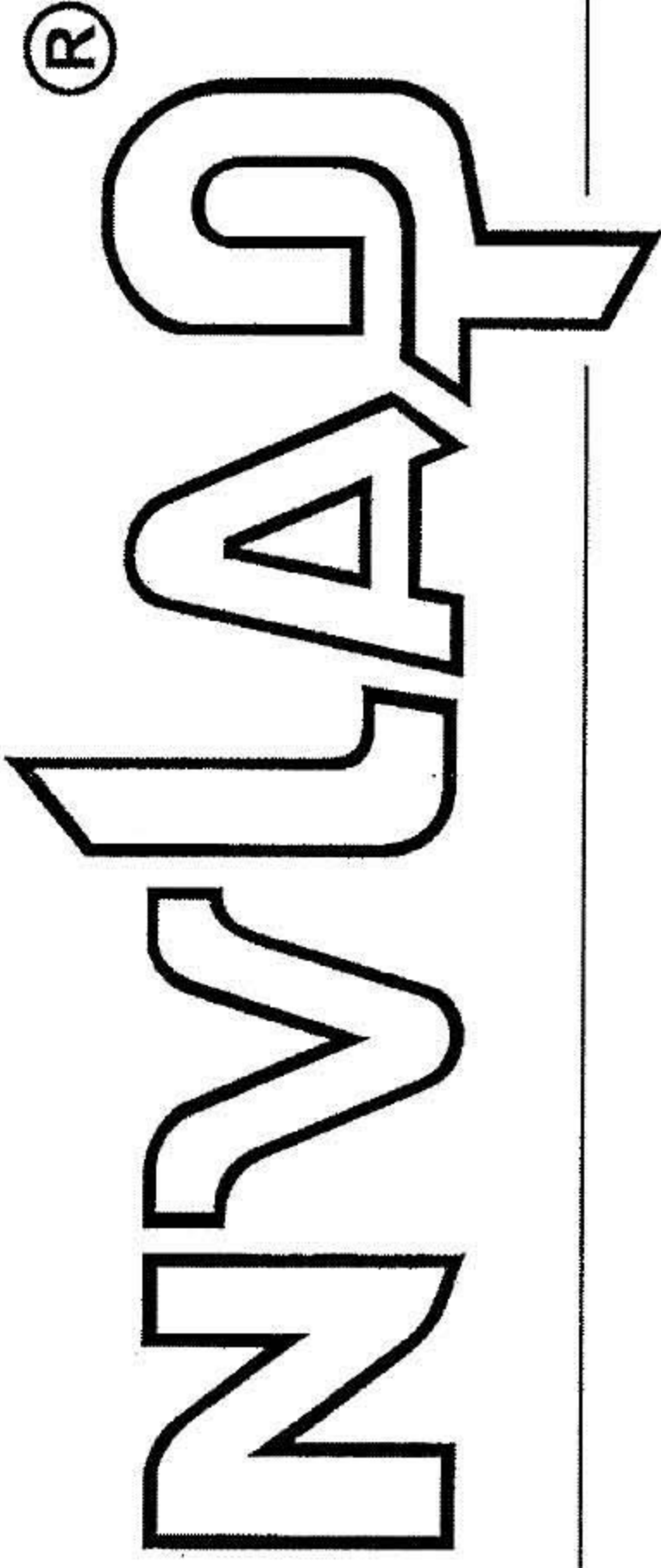

---

## Certificate of Accreditation to ISO/IEC 17025:2005

---

NVLAP LAB CODE: 200331-0

**HomeTek Technology Inc.**

Taipei Shien 236

TAIWAN

is accredited by the National Voluntary Laboratory Accreditation Program for specific services,  
listed on the Scope of Accreditation, for:

**ELECTROMAGNETIC COMPATIBILITY AND TELECOMMUNICATIONS**

*This laboratory is accredited in accordance with the recognized International Standard ISO/IEC 17025:2005.  
This accreditation demonstrates technical competence for a defined scope and the operation of a laboratory quality  
management system (refer to joint ISO-ILAC-IAF Communique dated 18 June 2005).*

2007-10-01 through 2008-09-30

Effective dates



*Dolly S. Bruce*

For the National Institute of Standards and Technology