



ADDRESS: No. 67-9, Shir Men Road, Tu Cheng City,  
Taipei Hsien, Taiwan

PHONE : 886-2-22608375 FAX : 886-2-22748013

E - mail : hometek@ms15.hinet.net

## CE TEST REPORT FOR

APPLICANT : Smart Home Engineering Corp.  
ADDRESS : 10F., No. 493, Chung-Cheng Rd.,  
Hsin-Tien City, Taipei 231, Taiwan, R. O. C.  
Receipt Date : 05/15/2007 Final Test Date: 05/29/2007  
EUT : Component video & digital audio CAT5  
Extender  
MODEL NO. : YX0XX, YE0XX

### MEASUREMENT PROCEDURE USED

EN 61000-6-3 / CISPR 22 Class B / EN61000-3-2 / EN61000-3-3 / EN 50130-4 GIVEN IN  
EUROPEAN COUNCIL DIRECTIVE 2004/108/EC

This test result of this report applies to above tested sample only.

This test report shall not be reproducing in part without written approval of HomeTek Technology Inc.

PREPARED BY :

HomeTek Technology Inc.

No. 67-9, Shir Men Road, Tu Cheng City,

Taipei Hsien. Taiwan

Report # : EB6K042

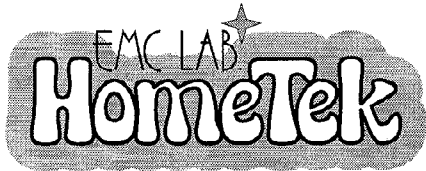

HomeTek Technology Inc.

ADDRESS: No. 67-9, Shir Men Road, Tu Cheng City,  
Taipei Hsien, Taiwan

PHONE : 886-2-22608375 FAX : 886-2-22748013

E - mail : hometek@ms15.hinet.net

## CERTIFICATE OF COMPLIANCE

EUT : Component video & digital audio CAT5 Extender  
 MODEL NO. : YX0XX, YE0XX  
 Receipt Date : 05/15/2007 Final Test Date: 05/29/2007  
 REPORT # : EB6K042  
 APPLICANT : Smart Home Engineering Corp.  
 ADDRESS : 10F., No. 493, Chung-Cheng Rd.,  
Hsin-Tien City, Taipei 231, Taiwan, R. O. C.

Measurement procedure used:

**EMI: EN 61000-6-3 (2001): CISPR 22 Class B (1997),  
EN 61000-3-2 (2000), EN 61000-3-3 (1995) + A1 (2001)**

**EMS: EN 50130-4 (1995) + A1 (1998) + A2 (2003):**

**IEC 61000-4-2 (2001), IEC 61000-4-3 (2002), IEC 61000-4-4 (2004),  
IEC 61000-4-5 (2001), ENV 50141 (1993), IEC 61000-4-11 (2004)**

We hereby show that:

The measurements shown in this test report were made in accordance with the procedures given in **EUROPEAN COUNCIL DIRECTIVE 2004/108/EC**, and the energy emitted by the equipment was found to be within the limits applicable. This product, which has been issued the test report listed as above in HomeTek Technology Inc., is based on single evaluation of one sample and confirmed to comply with the requirements of the above-mentioned EMC standard.

This test report is a duplicate of original one (report No. EB6E028, issued on 2007, 05, 31),  
applicant and model No. is modified.

APPROVED BY :

ALAIN LIN / Assistant Manage

**TEST REPORT CERTIFICATION****EMC of electrical appliances**

Report reference No. : EB6K042  
Date of issue : DEC., 14, 2007  
Applicant : Smart Home Engineering Corp.  
Address : 10F., No. 493, Chung-Cheng Rd.,  
Hsin-Tien City, Taipei 231, Taiwan, R. O. C.  
Manufacturer : Smart Home Engineering Corp.  
Type of test object : Component video & digital audio CAT5 Extender  
Model/type reference : YX0XX, YE0XXX  
Rated Voltage : N/A  
EUT Voltage : N/A  
Test Result : Complied  
Testing laboratory : HomeTek Technology Inc.  
Address : No. 67-9, Shir Men Road, Tu Cheng City, Taipei Hsien,  
Taiwan, R. O. C.  
TEL / FAX : +886-2-22608375 / +886-2-22748013  
E-mail : hometek@ms15.hinet.net  
Standard : EN 61000-6-3 (2001): CISPR 22 Class B (1997),  
EN 61000-3-2 (2000), EN 61000-3-3 (1995) + A1 (2001)  
EN 50130-4 (1995) + A1 (1998) + A2 (2003):  
IEC 61000-4-2 (2001), IEC 61000-4-3 (2002),  
IEC 61000-4-4 (2004), IEC 61000-4-5 (2001),  
ENV 50141 (1993), IEC 61000-4-11 (2004)

Tested by (+ signature) :

Jason Lin / Engineer



Approved by (+ signature) :

Alain Lin / Assistant Manager

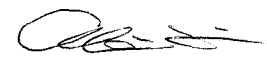



**TEST REPORT CERTIFICATION..... 1**

**TABLE OF CONTENTS..... 2**

**GENERAL INFORMATION..... 4**

**MODIFICATION LIST..... 5**

**CONDUCTED POWER LINE TEST ..... 6**

1 TEST PROCEDURE..... 6

2 RESULT OF CONDUCTED EMISSION TEST..... 6

**RADIATED EMISSION TEST..... 7**

1 TEST INSTRUMENTS & FACILITIES..... 7

2 TEST PROCEDURE..... 8

3 TEST SETUP ..... 8

4 CONFIGURATION OF THE EUT ..... 9

5 EUT OPERATING CONDITION..... 13

6 LIMIT OF RADIATED EMISSION CLASS B ..... 14

7 RESULT OF RADIATED EMISSION TEST..... 14

8 RADIATED EMISSION TEST DATA (PAGE 1)..... 15

9 RADIATED EMISSION TEST DATA (PAGE 2)..... 16

**HARMONICS TEST..... 17**

1 TEST PROCEDURE..... 17

2 RESULT OF HARMONICS TEST ..... 17

**VOLTAGE FLUCTUATIONS TEST ..... 18**

1 TEST PROCEDURE..... 18

2 RESULT OF VOLTAGE FLUCTUATIONS TEST ..... 18

**ELECTROSTATIC DISCHARGE IMMUNITY TEST (ESD) ..... 19**

1 TEST INSTRUMENTS & FACILITIES..... 19

2 TEST PROCEDURE..... 19

3 TEST SETUP ..... 19

4 CONFIGURATION OF THE EUT ..... 20

5 EUT OPERATION CONDITION..... 20

6 TEST CONDITION ..... 20

7 PERFORMANCE CRITERIA ..... 20

8 TEST RESULT ..... 21

**RADIO FREQUENCY ELECTROMAGNETIC FIELD IMMUNITY TEST (RF)..... 22**

1 TEST INSTRUMENTS & FACILITIES..... 22

2 TEST PROCEDURE..... 22

3 TEST SETUP ..... 23

4 CONFIGURATION OF THE EUT ..... 24

5 OPERATION CONDITION OF EUT..... 24



6 TEST CONDITION ..... 24

7 PERFORMANCE CRITERIA ..... 24

8 TEST RESULT ..... 25

**ELECTRICAL FAST TRANSIENT/BURST IMMUNITY TEST (EFT)..... 26**

1 TEST INSTRUMENTS & FACILITIES..... 26

2 TEST PROCEDURE..... 26

3 TEST SETUP ..... 26

4 CONFIGURATION OF THE EUT ..... 27

5 OPERATION CONDITION OF EUT ..... 27

6 TEST CONDITION ..... 27

7 PERFORMANCE CRITERIA ..... 27

8 TEST RESULT ..... 28

**SURGE IMMUNITY TEST ..... 29**

1 TEST PROCEDURE..... 29

2 RESULT OF SURGE IMMUNITY TEST ..... 29

**IMMUNITY TEST TO CS CONDUCTED DISTURBANCE ..... 30**

1 TEST INSTRUMENTS & FACILITIES..... 30

2 TEST PROCEDURE..... 30

3 TEST SETUP ..... 31

4 TEST LEVELS..... 32

5 CONFIGURATION OF THE EUT ..... 32

6 EUT OPERATION CONDITION..... 32

7 CONDITIONS DURING TESTING..... 32

8 PERFORMANCE CRITERIA ..... 33

9 TEST RESULT ..... 33

**VOLTAGE DIPS, SHORT INTERRUPTIONS IMMUNITY TEST AND MAIN SUPPLY VARIATIONS ..... 34**

1 TEST PROCEDURE..... 34

2 RESULT OF VOLTAGE DIPS, SHORT INTERRUPTIONS IMMUNITY TEST ..... 34

**APPENDIX A**

PHOTOS OF TEST CONFIGURATION

**APPENDIX B**

PHOTOS OF EUT

**GENERAL INFORMATION**

- 1 APPLICANT : Smart Home Engineering Corp.
- 2 ADDRESS : 10F., No. 493, Chung-Cheng Rd.,  
Hsin-Tien City, Taipei 231, Taiwan, R. O. C.
- 3 MANUFACTURER : Smart Home Engineering Corp.
- 4 ADDRESS : 10F., No. 493, Chung-Cheng Rd.,  
Hsin-Tien City, Taipei 231, Taiwan, R. O. C.
- 5 DESCRIPTION OF EUT :
- EUT : Component video & digital audio CAT5 Extender
- Model : YX0XX, YE0XXX
- Serial # : N/A

5.1 The difference between series of models YX0XX and YE0XXX are as shown below:

- (1) The first and second “X” represents different system input.
- (2) The third “X” represent different accessory.

The PCB layout is similar. The worst case of EMC test data were shown in this test report.

- 6 FEATURES OF EUT :

**Please refer to user manual or product specification.**



HomeTek Technology Inc.

## **MODIFICATION LIST**

THE FOLLOWING ACCESSORIES WERE ADDED TO THE EUT DURING TESTING :

NO MODIFICATION BY HOMETEK TECHNOLOGY INC.

## **CONDUCTED POWER LINE TEST**

### **1 TEST PROCEDURE**

According to **EN 61000-6-3 Class B**.

### **2 RESULT OF CONDUCTED EMISSION TEST**

N/A (Conducted Power Line Test is not applicable to this EUT ( Model : YE01D)).

## RADIATED EMISSION TEST

### 1 TEST INSTRUMENTS & FACILITIES

The following test Instruments was used during the radiated emission test :

Item	Instruments /facilities	Specification	Manufacturer	Model # / S/N#	Date of Cal.
1	OPEN AREA TEST SITE	<input checked="" type="checkbox"/> OATS 3			JUL/2006
2	EMI TEST RECEIVER	20Hz ~ 26.5GHz	ROHDE & SCHWARZ	ESMI 845442/006	FEB/2007
3	PRE-AMPLIFIER	9KHz ~ 3000MHz	ADVANTEST	BB525C 90081001	OCT/2006
4	ANTENNA (BI-LOG)	25MHz ~ 2GHz	SCHAFFNER	CBL6112B S/N : 2614	JUN/2006
5	Attenuation	50 $\Omega$ /6dB	JYE BAO	FAT-N (M-F) 001	JUL/2006
6	Cable	10m	SUHNER	RG214/U OS3-003	DEC/2006
7	Cable	14m	BELDEN	9913 OS3-001	DEC/2006
8	EMI 32 (software)	N/A	AUDIX	19991013-0923	N/A

Note : Items 1 ~ 7 were calibrated within period of 1 year.

## 2 TEST PROCEDURE

- 2.1 The EUT was test according to **CISPR 22 Class B**.
- 2.2 The radiated test was performed at HomeTek Lab's Open Site 3.
- 2.3 The frequency range from 30 MHz to 1 GHz, the measurement were made at 10 meters, with a BI-log antenna.

## 3 TEST SETUP

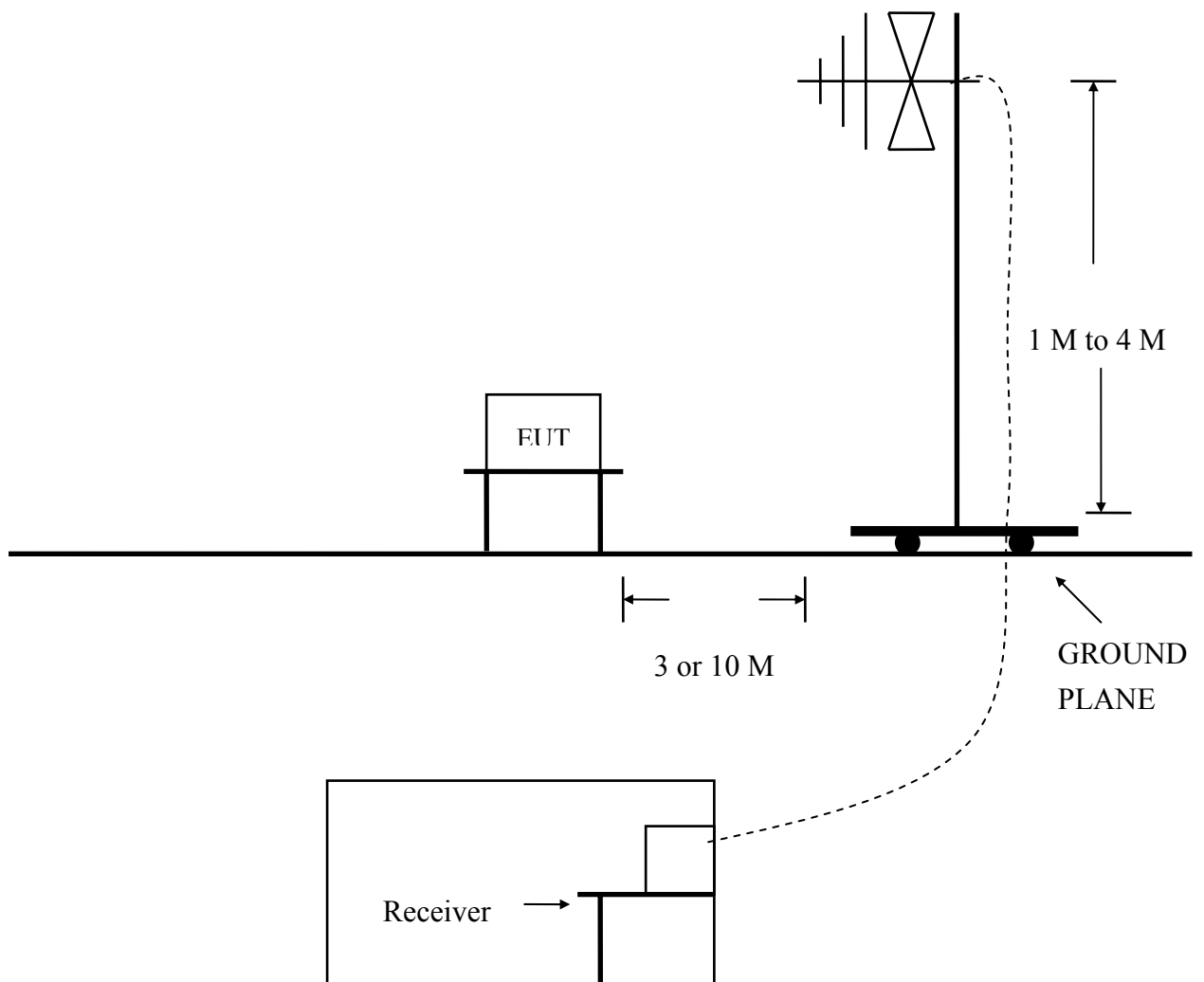

(Details for setup configuration, please refer to appendix A.)

#### 4 CONFIGURATION OF THE EUT

The EUT was configured according to **EN 61000-6-3**. All I/O ports were connected to the appropriate peripherals. All peripherals and cables are listed below (including internal device) :

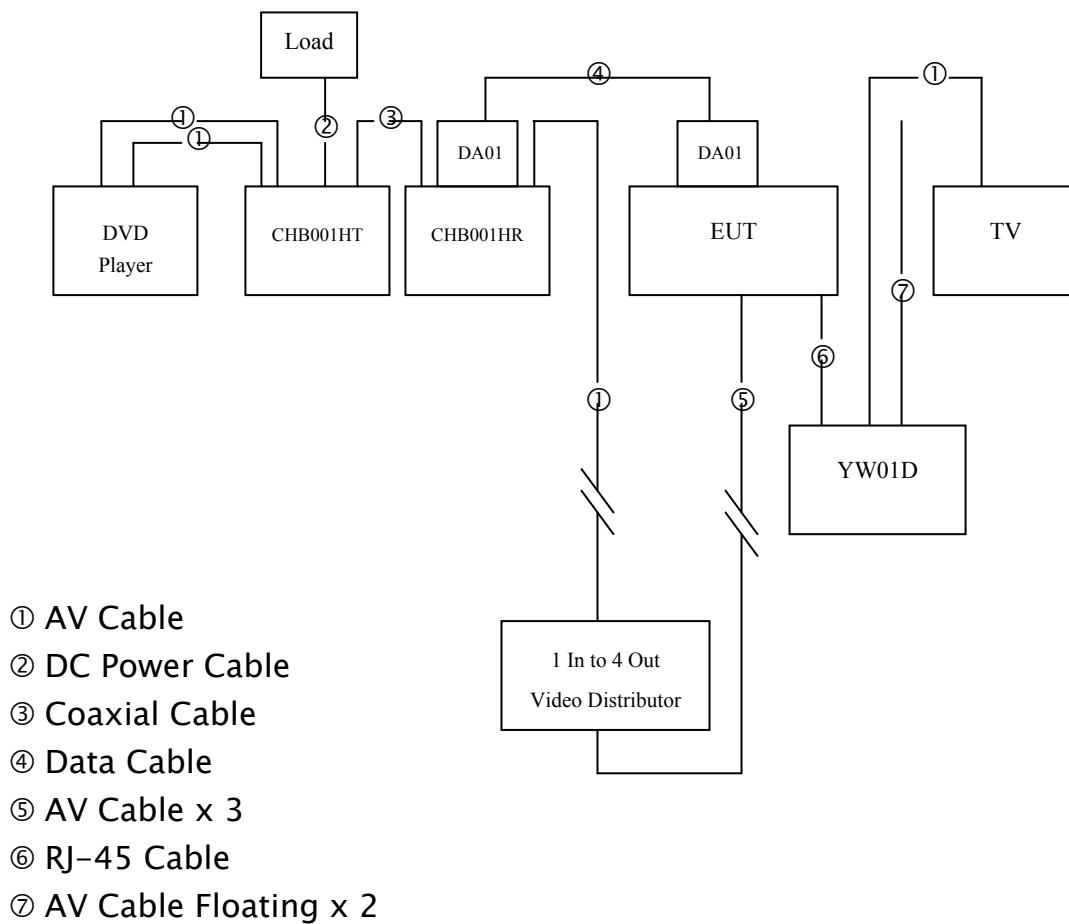

Figure 1



#### 4.1 EUT

EUT Type : Proto Type Engineer Type Mass Production  
Condition when received : Good Damage : \_\_\_\_\_  
Device : Component video & digital audio CAT5 Extender  
Applicant : Smart Home Engineering Corp.  
Manufacturer : Smart Home Engineering Corp.  
Model Number : YX0XX, YE0XXX  
Serial Number : N/A  
FCC ID : N/A  
RJ-45 Port : Plastics Type Connector  
Audio In Port : Metal Type Connector  
Y Port : Metal Type Connector  
Pb Port : Metal Type Connector  
Pr Port : Metal Type Connector  
Power Cord : N/A  
Power Supply Type : N/A

#### 4.2 PERIPHERALS

Digital Audio Transceiver x 2  
Manufacturer : SMART CABLING & TRANSMISSION CORP.  
Model Number : DA01  
Serial Number : N/A  
FCC ID : N/A  
Data Cable : Un-Shielded, 0.6 m  
Power Cord & Adaptor : N/A



Hi Frequency Interference Blocker

Manufacturer : SMART CABLING & TRANSMISSION CORP.  
Model Number : CHB001HT  
Serial Number : N/A  
FCC ID : N/A  
Data Cable 1 x 2 : Un-Shielded, 1.6 m, Connected to the AV port  
Data Cable 2 : Shielded, 1.8 m, Connected to the Coaxial port  
Power Cord : Un-Shielded, 1.8 m

Hi Frequency Interference Blocker

Manufacturer : SMART CABLING & TRANSMISSION CORP.  
Model Number : CHB001HR  
Serial Number : N/A  
FCC ID : N/A  
Data Cable 1 : Un-Shielded, 10 m, Connected to the AV port  
Data Cable 2 : Shielded, 1.8 m, Connected to the Coaxial port  
Power Cord : Un-Shielded, 1.8 m

Wall Plate Component Video & Digital Audio CAT5 Extender

Manufacturer : Smart Home Engineering Corp.  
Model Number : YW01D  
Serial Number : N/A  
FCC ID : N/A  
Data Cable 1 : Un-Shielded, 0.1 m, Connected to the RJ-45 port  
Data Cable 2 : Un-Shielded, 1.6 m, Connected to the AV port  
Power Cord : N/A



## HomeTek Technology Inc.

1 In to 4 Out Video Distributor

Manufacturer : SMART CABLING & TRANSMISSION CORP.  
Model Number : 15-VD14  
Serial Number : N/A  
FCC ID : N/A  
Data Cable x 4 : Un-Shielded, 0.6 m, Connected to the AV port  
Power Cord & Adaptor : Un-Shielded, 1.8 m

DVD Player

Manufacturer : LG  
Model Number : DS8421N  
Serial Number : N/A  
FCC ID : N/A  
Data Cable : Shielded, 1.6 m, Connected to the AV port  
Power Cord & Adaptor : Un-Shielded, 1.8 m

TV

Manufacturer : TCL  
Model Number : 1419A  
Serial Number : 010019502035F0039  
FCC ID : N/A  
Data Cable : Shielded, 1.6 m, Connected to the AV port  
Power Cord : Un-Shielded

Load

Manufacturer : HomeTek  
Specification : 20Ω  
Serial Number : N/A  
FCC ID : N/A  
Data Cable : N/A  
Power Cord : Un-Shielded, 0.3 m

4.3 REMARK : N/A

## 5 EUT OPERATING CONDITION

5.1 The frequency of the EUT is none.

5.2 The radiated emission in the frequency range from 30 MHz - 1000 MHz was test in a horizontal and vertical polarization at HomeTek Lab's open site 3.

5.3

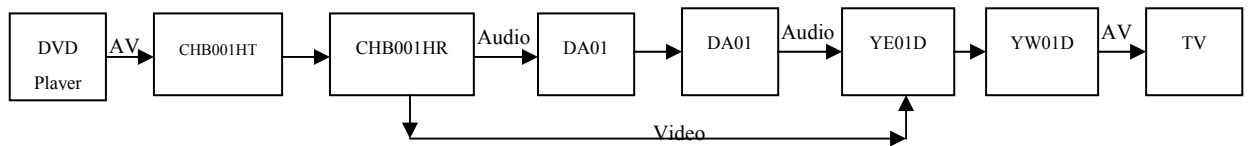

5.4 DVD Player send AV signal to CHB001HT, CHB001HR, DA01 x 2, YE01D, YW01D, and CHB001HT, CHB001HR, DA01 x 2, YE01D, YW01D change AV signal.

5.5 Then has changed AV signal send to TV display.

5.6 Measure the maximum emission noise.

**5.7 The photos of radiated test configuration, please refer to appendix A.**

## 6 LIMIT OF RADIATED EMISSION CLASS B

Frequency (MHz)	Measurement Distance	Limit (dBuV/m)
30 - 230	10 (M)	30
230 - 1000	10 (M)	37

## 7 RESULT OF RADIATED EMISSION TEST

- 7.1 The frequency range from 30 MHz to 1 GHz was investigated.
- 7.2 All readings below or equal 1 GHz are quasi-peak or peak values with resolution bandwidth of 120 KHz.
- 7.3 The measurements were made at 10 meters of HomeTek Lab's open site 3.
- 7.4 Temperature : 26 °C, Humidity : 56 % RH.
- 7.5 Deviation form the test standards and rules : None.
- 7.6 The radiated emission result were gained by the following method :  
 Level = Reading Level + Probe Factor (Antenna Factor) + Cable Loss – Preamp Factor  
 Over Limit = Level – Limit Line
- 7.7 Result : **PASSED**



HomeTek Technology Inc.

No 67-9, Shi-Men Rd., Tu-Chen City, Taipei County, Taiwan R.O.C. Tel: 02-22608375 Fax: 02-22748013

Data#: 4 File#: 6e028.EMI

Date: 2007-05-26 Time: 14:48:24

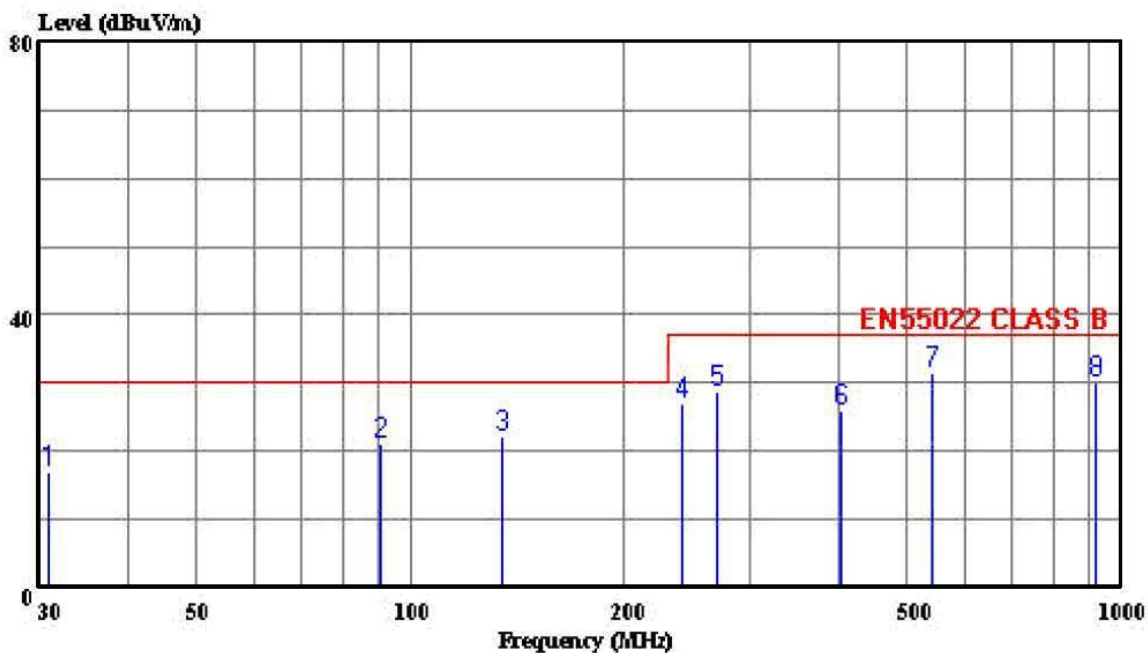

Trace:

Ref Trace:

Condition: EN55022 CLASS B 10m CHASE 2614 060506 HORIZONTAL  
cut : Component video & digital audio CAT5 Extender  
power: 230V/50Hz  
memo : YE01D

Page: 1

	Freq	Level	Limit	Over	ReadAntenna	Cable	Preamp	Remark
	MHz	dBuV/m	dBuV/m	dB	dBuV	dB/m	dB	dB
1	30.850	17.09	30.00	-12.91	24.25	18.22	0.64	26.02 Peak
2	90.750	20.97	30.00	-9.03	36.47	9.06	1.36	25.91 Peak
3	133.898	22.33	30.00	-7.67	34.97	11.46	1.73	25.83 Peak
4	241.501	27.11	37.00	-9.89	38.71	11.61	2.42	25.62 Peak
5	270.638	28.70	37.00	-8.30	39.05	12.62	2.60	25.56 Peak
6	404.483	26.07	37.00	-10.93	32.22	15.68	3.37	25.20 Peak
7	541.443	31.39	37.00	-5.61	32.79	18.49	4.78	24.68 Peak
8	920.290	30.21	37.00	-6.79	27.96	20.51	5.13	23.39 Peak
9	920.290	30.21	37.00	-6.79	27.96	20.51	5.13	23.39 Peak



# 9 RADIATED EMISSION TEST DATA (PAGE 2)



HomeTek Technology Inc.

No 67-9, Shi-Men Rd., Tu-Chen City,  
Taipei County, Taiwan R.O.C.  
Tel: 02-22608375  
Fax: 02-22748013

Data#: 3 File#: 6e028.EMI

Date: 2007-05-26 Time: 13:56:38

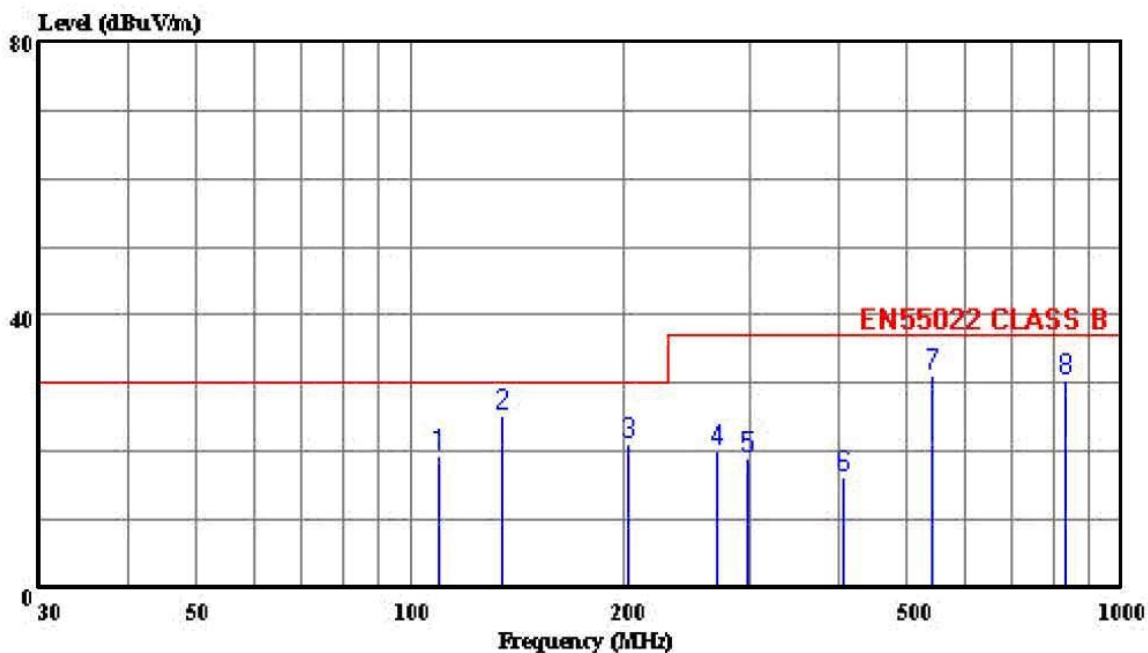

Trace:

Ref Trace:

Condition: EN55022 CLASS B 10m CHASE 2614 060506 VERTICAL  
cut : Component video & digital audio CAT5 Extender  
power: 230V/50Hz  
memo : YE01D

Page: 1

	Freq	Level	Limit	Over	Read	Antenna	Cable	Preamp	Remark
	MHz	dBuV/m	dBuV/m	dB	Level	Factor	Loss	Factor	
					dBuV	dB/m	dB	dB	
1	109.385	19.46	30.00	-10.54	31.77	12.03	1.54	25.88	Peak
2	133.963	25.21	30.00	-4.79	37.85	11.46	1.73	25.83	Peak
3	202.100	21.06	30.00	-8.94	35.53	9.10	2.13	25.71	Peak
4	269.988	20.06	37.00	-16.94	30.41	12.62	2.60	25.56	Peak
5	297.055	19.06	37.00	-17.94	28.75	13.06	2.75	25.50	Peak
6	405.138	16.11	37.00	-20.89	22.26	15.68	3.37	25.20	Peak
7	541.090	31.07	37.00	-5.93	32.47	18.49	4.78	24.68	Peak
8	834.787	30.32	37.00	-6.68	28.69	20.13	5.15	23.65	Peak

## **HARMONICS TEST**

### **1 TEST PROCEDURE**

According to **EN 61000-3-2 (2000)**.

### **2 RESULT OF HARMONICS TEST**

N/A (This standard is not applicable to this EUT ( Model : YE01D)).

## **VOLTAGE FLUCTUATIONS TEST**

### **1 TEST PROCEDURE**

According to **EN 61000-3-3 (1995) + A1 (2001)**.

### **2 RESULT OF VOLTAGE FLUCTUATIONS TEST**

N/A (This standard is not applicable to this EUT ( Model : YE01D)).

## ELECTROSTATIC DISCHARGE IMMUNITY TEST (ESD)

### 1 TEST INSTRUMENTS & FACILITIES

Instruments/ Facilities	Manufacturer	Model # Serial #	Data Of Cal.
ESD TESTER	HAEFELY	PESD 1610	NOV/2006
VCP	HOMETEK	--	--

### 2 TEST PROCEDURE

According to **IEC 61000-4-2 (2001)**

According to **EN 50130-4 (1995) + A1 (1998) +A2 (2003)**

### 3 TEST SETUP

TABLE SIZE

160L X 80W X 80H cm

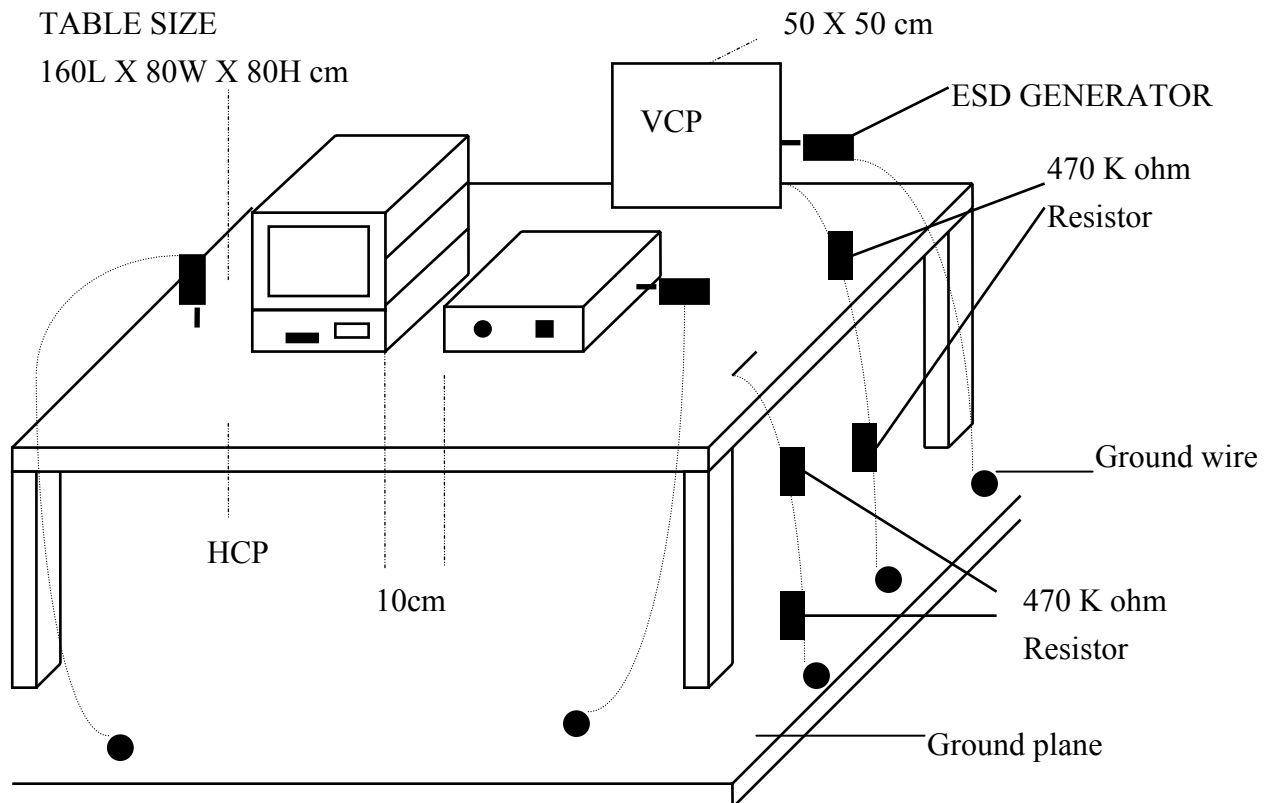

(Details for setup configuration, please refer to appendix A.)

#### 4 CONFIGURATION OF THE EUT

Same as “Radiated Emission test”, section 4

#### 5 EUT OPERATION CONDITION

Same as “Radiated Emission test”, section 5

#### 6 TEST CONDITION

##### 6.1 Test Level :

(A)  $\pm 2$ ,  $\pm 4$ ,  $\pm 8$ KV for air discharge.

(B)  $\pm 2$ ,  $\pm 4$ ,  $\pm 6$ KV for contact discharge.

6.2 Number of test : 10 Discharges / Test point / Polarity / Level

6.3 Time between test :  $\geq 1$  sec.

6.4 Temperature : 23 °C

6.5 Humidity : 41 % RH.

#### 7 PERFORMANCE CRITERIA

There shall be no damage, malfunction or change of status due to the conditioning. Flickering of an indicator during the application of the discharges is permissible, providing that there is no residual change in the EUT or any change in outputs, which could be interpreted by associated equipment as a change.

The EUT shall meet the acceptance criteria for the functional test, after the conditioning.

## 8 TEST RESULT

Test Point	Air Discharge	Contact Discharge	Result
HCP	---	$\pm 2, \pm 4, \pm 6\text{KV}$	<b>PASSED</b>
VCP	---	$\pm 2, \pm 4, \pm 6\text{KV}$	<b>PASSED</b>
CASE	$\pm 2, \pm 4, \pm 8\text{KV}$	$\pm 2, \pm 4, \pm 6\text{KV}$	<b>PASSED</b>
I/O PORTS	$\pm 2, \pm 4, \pm 8\text{KV}$	$\pm 2, \pm 4, \pm 6\text{KV}$	<b>PASSED</b>
SCREWS	$\pm 2, \pm 4, \pm 8\text{KV}$	$\pm 2, \pm 4, \pm 6\text{KV}$	<b>PASSED</b>

※ There is no significant change during the test.

## 9 Photos of test configuration please refer to appendix A.

## RADIO FREQUENCY ELECTROMAGNETIC FIELD IMMUNITY TEST (RS)

### 1 TEST INSTRUMENTS & FACILITIES

Item	Instruments Facilities	Manufacturer	Model # Serial #	Data Of Cal.
1	SIGNAL GENERATOR	ROHDE & SCHWARZ	SMY02 845181/025	MAR/2007
2	AMPLIFIER	AMPLIFIER RESEARCH	100W1000M1A	N/A
3	FIELD SENSOR	AMPLIFIER RESEARCH	FP2000	AUG/2006
4	FIELD MONITOR	AMPLIFIER RESEARCH	FM2000	AUG/2006
5	RF VOLTMETER	BOONTON	9200C 361701AA	MAR/2007
6	RF PROBE	BOONTON	952001B 37082	MAR/2007
7	DIRECTION COUPLER	AMPLIFIER RESEARCH	DC6180 20521	N/A
8	ANTENNA	EMCO	3142B S/N: 1789	N/A
9	CONTROL PC	KB TECH	KB P586/133	--

Note : Items 3 ~ 4 were calibrated with two years and verified before testing.

### 2 TEST PROCEDURE

According to **IEC 61000-4-3 (2002)**

According to **EN 50130-4 (1995) + A1 (1998) + A3 (2003)**

### 3 TEST SETUP

#### FERRITE TILE

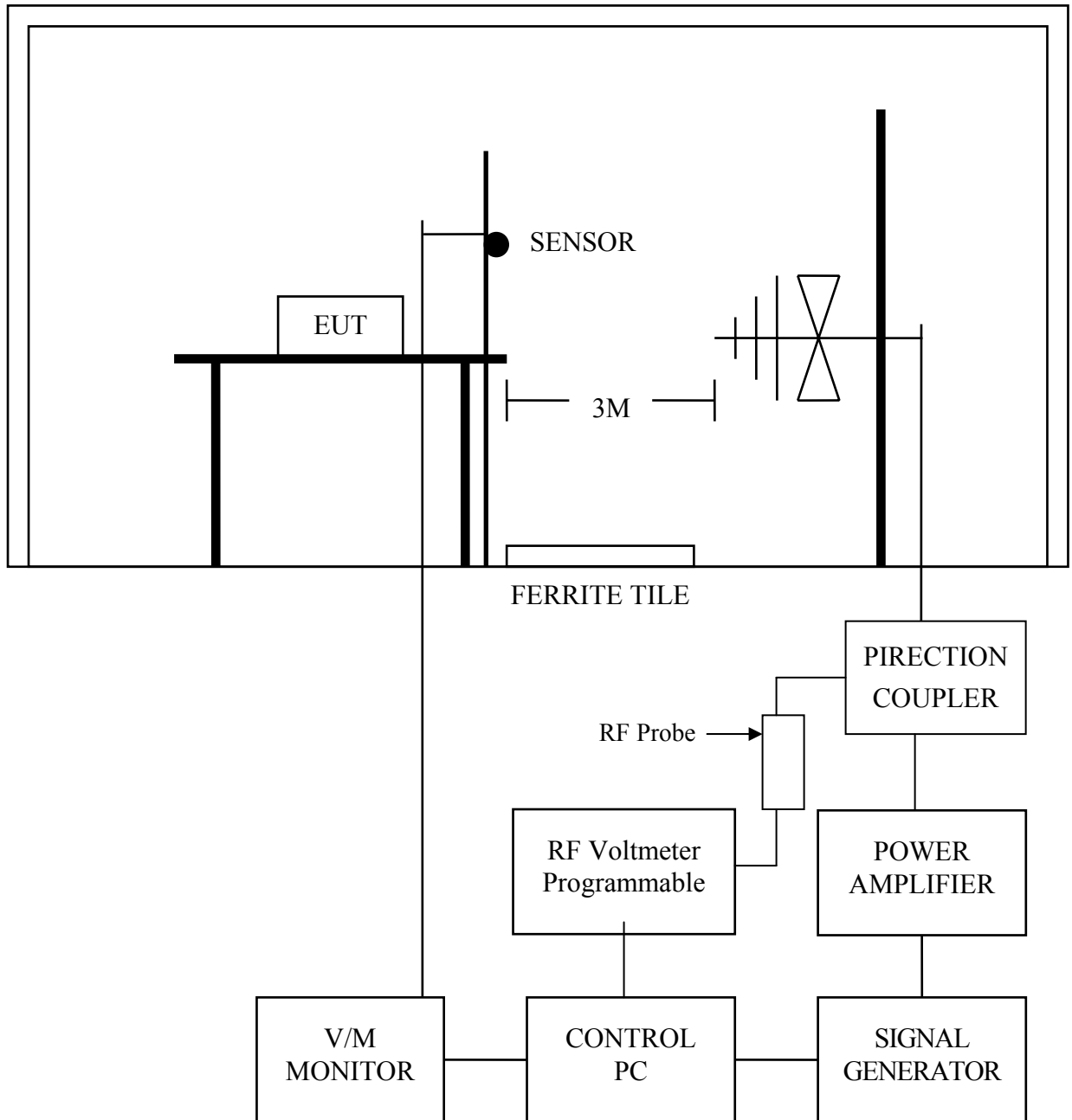

#### 3.1 Chamber Size :

12M x 5M x 5M

(Details for setup configuration, please refer to appendix A.)

#### 4 CONFIGURATION OF THE EUT

Same as “Radiated Emission test”, section 4

#### 5 OPERATION CONDITION OF EUT

Same as “Radiated Emission test”, section 5

#### 6 TEST CONDITION

6.1 Frequency Range : 80 MHz ~ 1000 MHz

6.2 Field Strength : 10 V / M (1KHz 80% Sinusoidal amplitude modulation)  
10 V / M (1KHz 0.5s on : 0.5s off pulse modulation)

6.3 Frequency Step : 1 %, 3 sec. / each step size

6.4 Antenna Polarity : HORIZONTAL & VERTICAL

6.5 The four sides of EUT are tested  
(FRONT, REAR, RIGHT, LEFT)

6.6 Temperature : 24 °C

6.7 Humidity : 58 % RH

#### 7 PERFORMANCE CRITERIA

There shall be no damage, malfunction or change of status due to the conditioning. Flickering of an indicator during the conditioning is permissible, providing that there is no residual change in the EUT or any change in outputs, which could be interpreted by associated equipment as a change, and no such flickering of indicators occurs at a field strength of 3 V/m.

For components of CCTV system, where the status is monitored by observing the TV picture, then deterioration of the picture is allowed at 10 V/m, providing :

- a There is no permanent damage or change to the EUT (e.g. no corruption of memory or changes to programmable setting etc.);
- b At 3 V/m, any deterioration of the picture is so minor that the system could still be used;
- c There is no observable deterioration of the picture at 1 V/m.

The EUT shall meet the acceptance criteria for the functional test, after the conditioning.

## 8 TEST RESULT

ANT SIDE	HORIZONTAL	VERTICAL
FRONT	PASSED	PASSED
REAR	PASSED	PASSED
RIGHT	PASSED	PASSED
LEFT	PASSED	PASSED

**9 Photos of test configuration please refer to appendix A.**

## ELECTRICAL FAST TRANSIENT/BURST IMMUNITY TEST (EFT)

### 1 TEST INSTRUMENTS & FACILITIES

Instruments/ Facilities	Manufacturer	Model # Serial #	Data Of Cal.
BURST-TESTER	HAEFELY	PEFT/JUNIOR	FEB/2007
CONTROL PC	KB TECH	KB P586/133	--

### 2 TEST PROCEDURE

According to **IEC 61000-4-4 (2004)**

According to **EN 50130-4 (1995) + A1 (1998) + A2 (2003)**

### 3 TEST SETUP

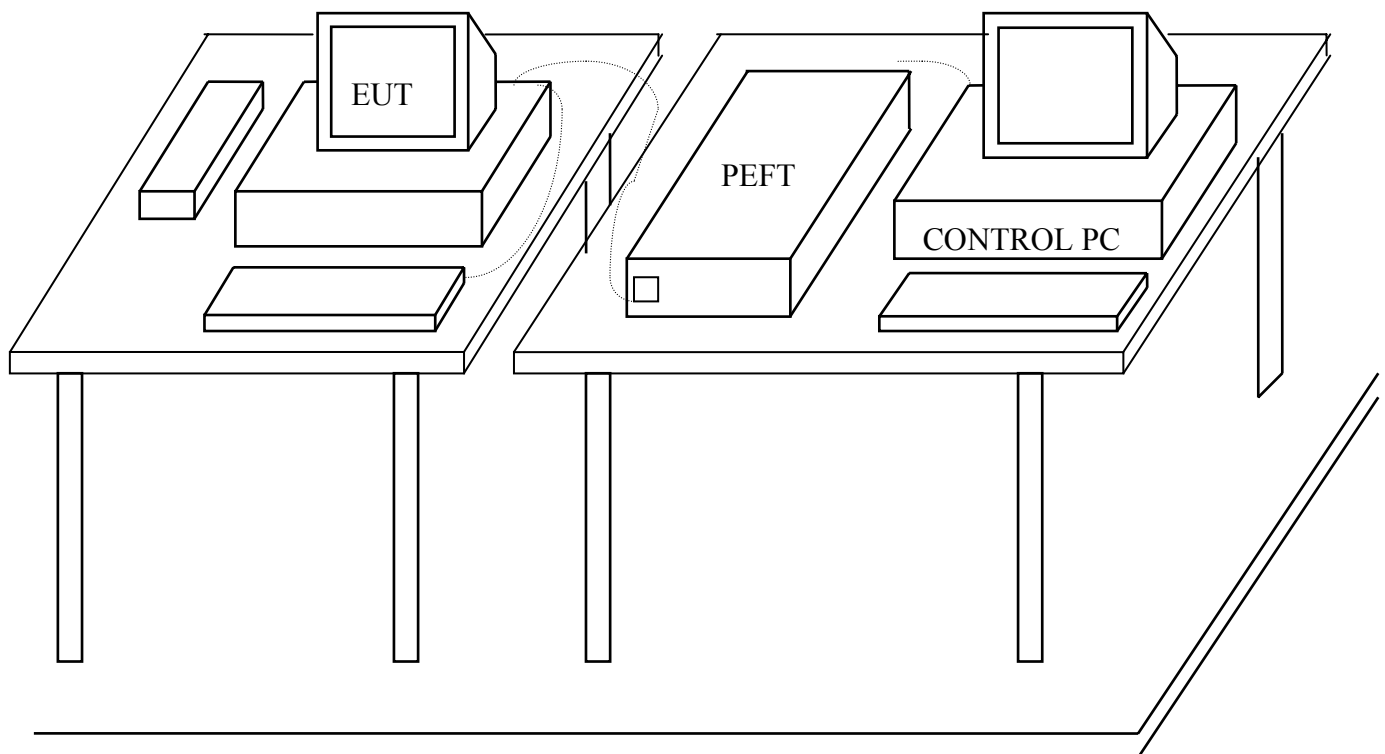

**GROUND PLANE**  
(Details for setup configuration, please refer to appendix A.)

#### 4 CONFIGURATION OF THE EUT

Same as “Radiated Emission test”, section 4

#### 5 OPERATION CONDITION OF EUT

Same as “Radiated Emission test”, section 5

#### 6 TEST CONDITION

6.1 Pulse Rise time & Duration : 5 nS / 50 nS

6.2 Pulse Repetition : 5 kHz

6.3 Polarity : POSITIVE / NEGATIVE

6.4 Coupling of power line :  
L, N, L+N

6.5 Test Voltage of Signal Control Line :  $\pm 0.25\text{KV}$ ,  $\pm 0.5\text{KV}$ ,  $\pm 1\text{KV}$

6.6 Temperature : 23 °C

6.7 Humidity : 55 % RH

#### 7 PERFORMANCE CRITERIA

There shall be no damage, malfunction or change of status due to the conditioning. Flickering of an indicator during the application of the bursts is permissible, providing that there is no residual change in the EUT or any change in outputs, which could be interpreted by associated equipment as a change.

The EUT shall meet the acceptance criteria for the functional test, after the conditioning.

## 8 TEST RESULT

Signal Control Line :

TEST VOLTAGE	PERFORMACE CRITERIA
±0.25KV	✓
±0.5KV	✓
±1KV	✓

8.1 Model : YE01D

8.2 Final Result : PASSED

8.3 Remark :

## 9 Photos of test configuration please refer to appendix A.

## **SURGE IMMUNITY TEST**

### **1 TEST PROCEDURE**

According To **IEC 61000-4-5 (2001)**

According To **EN 50130-4 (1995) + A1 (1998) + A2 (2003)**

### **2 RESULT OF SURGE IMMUNITY TEST**

N/A (This standard is not applicable to this EUT ( Model : YE01D)).

## IMMUNITY TEST TO CS CONDUCTED DISTURBANCE

### 1 TEST INSTRUMENTS & FACILITIES

Instruments/ Facilities	Manufacturer	Model # Serial #	Date Of Cal.
SIGNAL GENERATOR	ROHDE & SCHWARZ	SMY02 845181/025	MAR/2007
AMPLIFIER	AMPLIFIER RESEARCH	75A250 25680	N/A
RF VOLTMETER	BOONTON	9200C 361701AA	MAR/2007
RF PROBE	BOONTON	952001B 37082	MAR/2007
DIRECTION COUPLER	AMPLIFIER RESEARCH	DC2600 20508	N/A
COUPLING DECOUPLING NETWORK	FCC	FCC-801-M3-25A 9993	FEB/2007
CONTROL PC	KB TECH	KB P586/133	--

### 2 TEST PROCEDURE

According To **ENV 50141 (1993)**

According To **EN 50130-4 (1995) + A1 (1998) + A2 (2003)**

### 3 TEST SETUP

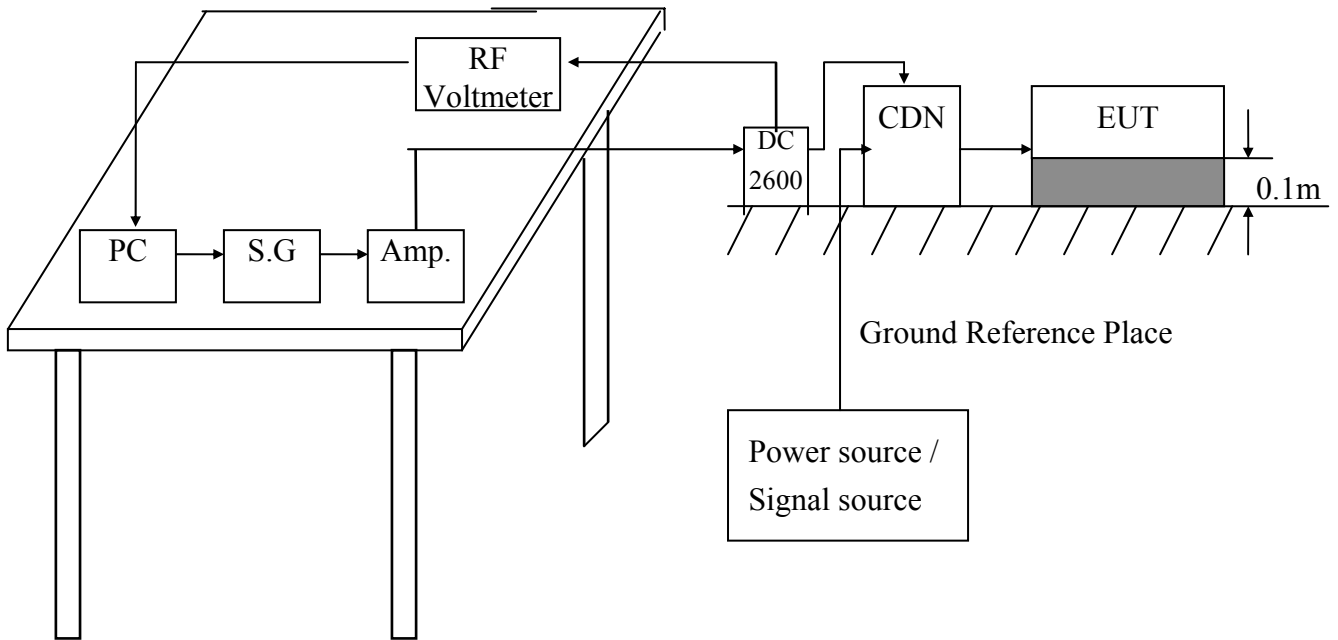

(Details for setup configuration, please refer to appendix A.)

#### 4 TEST LEVELS

- Ports for signal lines and control lines.
- DC input and DC output power ports.
- Input and Output AC Power Ports.
- Functional earth Ports.

Environmental	Test Specification	Units
Radio-frequency	0.15 - 100	MHz
Common mode	10	V
Amplitude Modulation	80	% (1KHz)
Pulse Modulation	1	Hz (0.5s on : 0.5s off)

#### 5 CONFIGURATION OF THE EUT

Same as “Radiated Emission test”, section 4

#### 6 EUT OPERATION CONDITION

Same as “Radiated Emission test”, section 5

#### 7 CONDITIONS DURING TESTING

7.1 The EUT tested type :

- Single unit
- Multiple unit

7.2 Dwell time : < 3 Seconds

7.3 Step size : < 1%

7.4 Test times : 3 times (pulse modulation)

7.5 Temperature : 23 °C (15°C ~ 35°C)

Humidity : 55 % RH.(10 % ~ 75%)

## 8 PERFORMANCE CRITERIA

There shall be no damage, malfunction or change of status due to the conditioning. Flickering of an indicator during the conditioning is permissible, providing that there is no residual change in the EUT or any change in outputs, which could be interpreted by associated equipment as a change, and no such flickering of the picture is allowed at 10V, providing :

- a There is no permanent damage or change to the EUT (e.g. no corruption of memory or changes to programmable settings etc.);
- b At  $U_0 = 3V$ , any deterioration of the picture is so minor that the system could still be used;
- c There is no observable deterioration of the picture at  $U_0 = 1V$ .

The EUT shall meet the acceptance criteria for the functional test, after the conditioning.

## 9 TEST RESULT

TEST Specification	Unit
0.15 - 100	MHz
10	V
80	% (1KHz)
1	Hz (0.5s on : 0.5s off)

9.1 Model : YE01D

9.2 Final Result : PASSED

9.3 Remark :

**10 Photos of test configuration please refer to appendix A.**

## **VOLTAGE DIPS, SHORT INTERRUPTIONS IMMUNITY TEST AND MAIN SUPPLY VARIATIONS**

### **1 TEST PROCEDURE**

According To **IEC 61000-4-11 (2004)**

According To **EN 50130-4 (1995) + A1 (1998) + A2 (2003)**

### **2 RESULT OF VOLTAGE DIPS, SHORT INTERRUPTIONS IMMUNITY TEST**

N/A (This standard is not applicable to this EUT ( Model : YE01D)).



HomeTek Technology Inc.

## **Appendix A**

# **PHOTOS OF TEST CONFIGURATION**

## PHOTO OF RADIATED EMISSION TEST

Model : YE01D

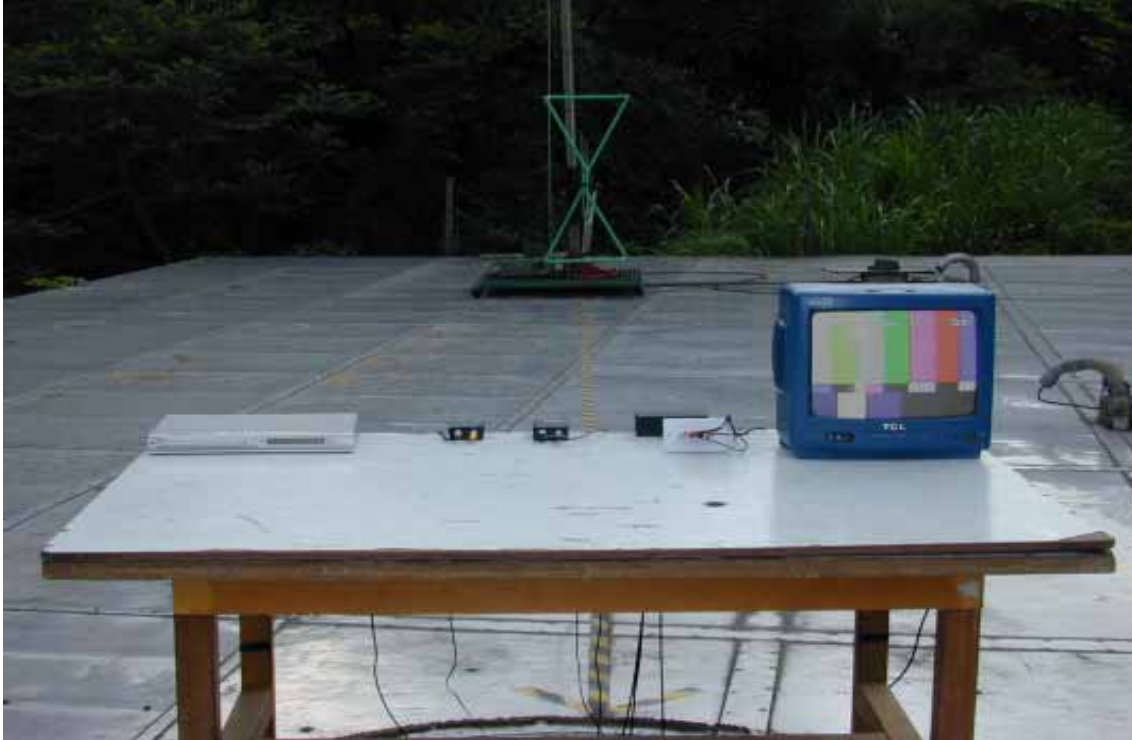

Front View



Rear View

**PHOTO OF RADIO FREQUENCY ELECTROMAGNETIC FIELD IMMUNITY TEST (RS)**

Model : YE01D



**PHOTO OF ELECTROSTATIC DISCHARGE IMMUNITY TEST (ESD)**



EB6K042



HomeTek Technology Inc.

## **Appendix B**

### **PHOTOS OF EUT**

### PHOTO OF EUT

Model : YE01D, YE02D



Full View of EUT

## PHOTO OF EUT

Model : YX0XX , YE0XXX



Component Side of Main Board

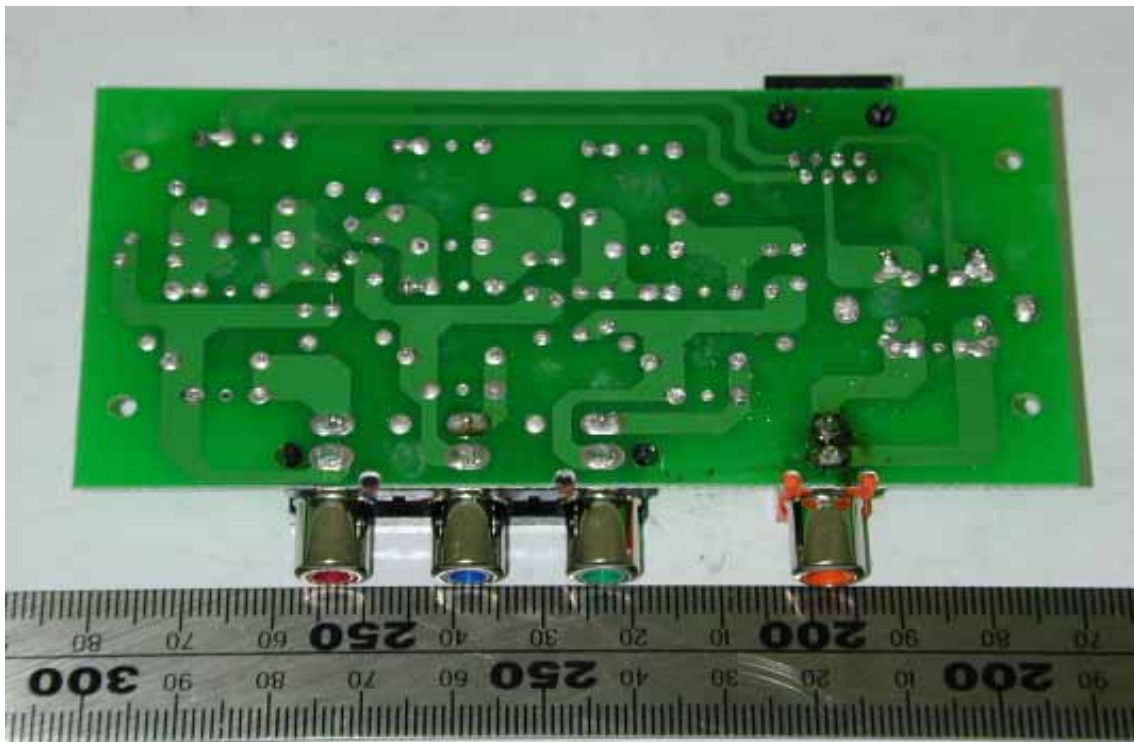

Solder Side of Main Board

# Declaration of Conformity

We(Manufacturer/Importer)

---

(company name)

---

(address)

declares under our sole responsibility that the product

Product name : Component video & digital audio CAT5  
Extender

Model No. : YX0XX, YE0XXX

to which this declaration relates is in conformity with the following standard(s) or other normative document(s)

- |   |   |
|---|---|
| <input checked="" type="checkbox"/> EN 61000-6-3 (2001)     | <input checked="" type="checkbox"/> EN 50130-4 (1995)<br>+ A1 (1998)<br>+ A2 (2003) |
| <input checked="" type="checkbox"/> CISPR 22 Class B (1997) | <input checked="" type="checkbox"/> IEC 61000-4-2 (2001)                            |
| <input checked="" type="checkbox"/> EN 61000-3-2 (2000)     | <input checked="" type="checkbox"/> IEC 61000-4-3 (2002)                            |
| <input checked="" type="checkbox"/> EN 61000-3-3 (1995)     | <input checked="" type="checkbox"/> IEC 61000-4-4 (2004)                            |
| + A1 (2001)   | <input checked="" type="checkbox"/> IEC 61000-4-5 (2001)                            |
|   | <input checked="" type="checkbox"/> ENV 50141 (1993)                                |
|   | <input checked="" type="checkbox"/> IEC 61000-4-11 (2004)                           |

following the provisions of 2004/108/EC Directive

Place: \_\_\_\_\_ Signature: \_\_\_\_\_

Date : \_\_\_\_\_ Full name: \_\_\_\_\_



Title: \_\_\_\_\_



TÜV Rheinland Taiwan Ltd.

# Certificate of Appointment

for the applicant:

**Hometek Technology Inc.  
No. 67-9, Shir Men Rd., Tu-Cheng City,  
Taipei Hsien 236, Taiwan, R.O.C.**

has been authorized to carry out EMC tests by order and under supervision of TÜV Rheinland. It has successfully demonstrated capability to conduct measurement and to process test data according to:

**European and International EMC Standards as listed in the  
Scope of Authorization on the attachment to this certificate**

An assessment of the facility was conducted by TÜV Rheinland auditors according to the TÜV Rheinland requirements for "Test Site Approval" with reference to

**ISO 17025: 2005**

Certificate No. : 10012161-2007

Valid until : Sept. 7, 2008

TÜV Rheinland Taiwan Ltd.  
Taipei, June 20, 2007

  
Dipl.-Ing. Andreas Klinker  
Certification Body

  
Dipl.-Ing. Bodo Kretzschmar  
Product Safety and Quality



Attachment to  
**Certificate**

of Appointment

SCOPE OF AUTHORIZATION

**Hometek Technology Inc.**  
**No. 67-9, Shir Men Rd., Tu-Cheng City,**  
**Taipei Hsien 236, Taiwan, R.O.C.**

**European Standards**

EN 50081-1	EN 61000-3-3	ENV 50140
EN 50081-2	EN 61000-6-1	ENV 50141
EN 50082-1	EN 61000-6-2	ENV 50204
EN 50130-4	EN 61000-6-3	
EN 50091-2	EN 61000-6-4	
EN 55011	EN 61000-3-11	
EN 55013	EN 61000-4-2	
EN 55014-1	EN 61000-4-3	
EN 55014-2	EN 61000-4-4	
EN 55022	EN 61000-4-5	
EN 55024	EN 61000-4-6	
EN 60601-1-2	EN 61000-4-8	
EN 60801	EN 61000-4-11	
EN 60945	EN 61204-3	
EN 61000-3-2	EN 62040-2	

**International Standards**

CISPR 11	IEC 61000-4-2	IEC 61000-3-2
CISPR 13	IEC 61000-4-3	IEC 61000-3-3
CISPR 14-1	IEC 61000-4-4	IEC 61000-3-11
CISPR 14-2	IEC 61000-4-5	IEC 61000-6-1
CISPR 22	IEC 61000-4-6	IEC 61000-6-2
CISPR 24	IEC 61000-4-8	IEC 61000-6-3
IEC 801.2	IEC 61000-4-11	IEC 61000-6-4
IEC 801.3	IEC 61000-4-12	IEC 60945
IEC 801.4		IEC 62040-2

**Certificate No. : 10012161-2007**

Taipei, June 20, 2007

  
Dipl.-Ing. Bodo Kretzschmar  
Product Safety and Quality