



HomeTek Technology Inc.

ADDRESS: No. 67-9, Shir Men Road, Tu Cheng City,
Taipei Hsien, Taiwan

PHONE : 886-2-22608375 FAX : 886-2-22748013

E - mail : hometek@ms15.hinet.net

FCC TEST REPORT FOR

APPLICANT	: <u>SMART CABLING & TRANSMISSION CORP.</u>
ADDRESS	: <u>10F, No. 493, Chung-Cheng Rd.,</u> <u>Hsin Tien City, Taipei 231, Taiwan, R. O. C.</u>
EUT	: <u>Video Distribution Amplifier</u>
MODEL NO.	: <u>CD8XXX</u>



Accredited by the National Voluntary Laboratory Accreditation Program
for the specific scope of accreditation under Lab Code 200331-0

MEASUREMENT PROCEDURE USED

FCC RULES AND CISPR 22-1997 AND FCC / ANSI C63.4-2003

PREPARED BY :

HomeTek Technology Inc.

No. 67-9, Shir Men Road, Tu Cheng City,

Taipei Hsien. Taiwan

Report # : FD5F020



TABLE OF CONTENTS..... 2

CERTIFICATION..... 3

GENERAL INFORMATION..... 4

MODIFICATION LIST..... 5

CONDUCTED POWER LINE TEST 6

1 TEST INSTRUMENTS & FACILITIES..... 6

2 TEST PROCEDURE..... 6

3 TEST SETUP 7

4 CONFIGURATION OF THE EUT 9

5 EUT OPERATING CONDITION..... 16

6 LIMIT OF CONDUCTED POWER LINE EMISSION CLASS B..... 17

7 RESULT OF CONDUCTED POWER LINE TEST..... 17

8 CONDUCTED POWER LINE TEST DATA (PAGE 1)..... 18

9 CONDUCTED POWER LINE TEST DATA (PAGE 2)..... 19

10 CONDUCTED POWER LINE TEST DATA (PAGE 3)..... 20

11 CONDUCTED POWER LINE TEST DATA (PAGE 4)..... 21

RADIATED EMISSION TEST..... 22

1 TEST INSTRUMENTS & FACILITIES..... 22

2 TEST PROCEDURE..... 23

3 TEST SETUP 23

4 CONFIGURATION OF THE EUT 25

5 EUT OPERATING CONDITION..... 25

6 LIMIT OF RADIATED EMISSION CLASS B 25

7 RESULT OF RADIATED EMISSION TEST..... 26

8 RADIATED EMISSION TEST DATA (PAGE 1)..... 27

9 RADIATED EMISSION TEST DATA (PAGE 2)..... 28

SAMPLE OF FCC DOC LABEL 1 29

SAMPLE OF FCC DOC LABEL 2 29

APPENDIX A

PHOTOS OF TEST CONFIGURATION

APPENDIX B

PHOTOS OF EUT

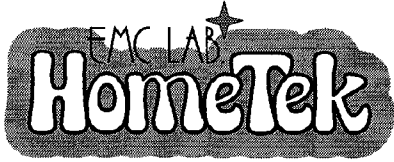

HomeTek Technology Inc.

ADDRESS: No. 67-9, Shir Men Road, Tu Cheng City, Taipei Hsien, Taiwan
PHONE : 886-2-22608375 FAX : 886-2-22748013
E - mail : hometek@ms15.hinet.net

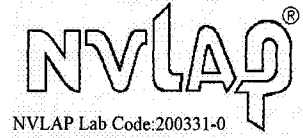

CERTIFICATION
for
FCC Part 15, Subpart B Class B

APPLICANT : SMART CABLING & TRANSMISSION CORP.
ADDRESS : 10F, No. 493, Chung-Cheng Rd., Hsin Tien City, Taipei 231, Taiwan, R. O. C.
Receipt Date : 06/15/2006 Final Test Date: 06/22/2006
EUT : Video Distribution Amplifier
MODEL NO. : CD8XXX

MEASUREMENT PROCEDURE USED :

PART 15 SUBPART B FCC RULES AND CISPR 22-1997
AND FCC / ANSI C63.4-2003

TEST PROCEDURE AND DATA ARE TRACEABLE TO NIST/USA,
TL or NML/TAIWAN.

- THE MAXIMUM EMISSION LEVELS WERE COMPARED TO THE CISPR 22 CLASS B LIMITS BOTH RADIATED AND CONDUCTED EMISSION.
THE ABOVE DEVICE WAS TESTED BY HOMETEK TECHNOLOGY INC. TO SHOWS THE MAXIMUM EMISSION LEVEL FROM THE DEVICE.
THIS TEST RESULTS OF THIS REPORT APPLIES TO ABOVE TESTED SAMPLE ONLY.
THIS TEST REPORT SHALL NOT BE REPRODUCE IN PART WITHOUT WRITTEN APPROVAL OF HOMETEK TECHNOLOGY INC.
THE REPORT MUST NOT BE USED BY THE CLIENT TO CLAIM PRODUCT ENDORSEMENT BY NVLAP OR ANY AGENCY OF THE U. S. GOVERNMENT.
THE TEST RESULTS ARE TRACEABLE TO THE NATIONAL OR INTERNATIONAL STANDARD.

APPROVED BY :

Albert Tsai 06/29/2006
ALBERT TSAI / Senior Engineer

GENERAL INFORMATION

- 1 APPLICANT : SMART CABLING & TRANSMISSION CORP.
- 2 ADDRESS : 10F, No. 493, Chung-Cheng Rd.,
Hsin Tien City, Taipei 231, Taiwan, R. O. C.
- 3 MANUFACTURER : SMART CABLING & TRANSMISSION CORP.
- 4 ADDRESS : 10F, No. 493, Chung-Cheng Rd.,
Hsin Tien City, Taipei 231, Taiwan, R. O. C.
- 5 DESCRIPTION OF EUT :
- EUT : Video Distribution Amplifier
- FCC ID : N/A
- Model Number : CD8XXX
- Serial # : N/A

5.1 The difference between series of models CD8XXX are as shown below:

C D 8 X X X

- (1) The first “X” represent different system input.
- (2) The second “X” represent different accessory.
- (3) The third “X” represent different color.

The PCB layout is similar. The worst case of model is CD816, and the final test data were shown in this test report.

- 6 FEATURES OF EUT :

Please refer to user manual or product specification.



HomeTek Technology Inc.

MODIFICATION LIST

THE FOLLOWING ACCESSORIES WERE ADDED TO THE EUT DURING TESTING :

NO MODIFICATION BY HOMETEK TECHNOLOGY INC.

CONDUCTED POWER LINE TEST

1 TEST INSTRUMENTS & FACILITIES

The following test Instruments was used during the conducted test :

Item	Instruments/ Facilities	Specification	Manufacturer	Model # S/N	Date Of Cal.
1	EMI Receiver	9KHz ~ 30MHz	ROHDE & SCHWARZ	ESHS 30 844827/007	FEB/2006
2	LISN (for EUT)	50Ω/50uH/100A 150KHz ~ 30MHz	SCHWARZ BECK	NNLK 8121 8121370	OCT/2005
3	LISN (for Support Unit)	50Ω/50uH/10A 9KHz ~ 30MHz	ROHDE & SCHWARZ	ESH3-Z5 846128/007	MAR/2006
4	Terminator	50Ω	N/A	N/A	NOV/2005
5	Attenuation	50Ω/10dB	Mini-Circuit	NAT-10 AT-002	JUL/2005
6	Cable	5.4m	SUHNER	RG-223 CON2-002	AUG/2005
7	ESXS-K1 (software)	Version 2.03b 9KHz ~ 30MHz	ROHDE & SCHWARZ	1082.9678.02 840.913/246	N/A

Note : Items 1 ~ 6 were calibrated within period of 1 year.

2 TEST PROCEDURE

- 2.1 The EUT was tested according to **ANSI C63.4 – 2003 Section 5.2, 7.1, 7.2 & CISPR 22 - 1997 & C18-01-12 (HomeTek test procedure)**.
- 2.2 The EUT was placed 0.4 meter from the conducting wall of shielding room and kept at least 0.8 meter from any other grounded conducting surface.
- 2.3 The frequency range form 0.15 MHz to 30 MHz was investigated.
- 2.4 The LISN used was 50 Ohm / 50 uHenry as specified by Section 4.1.2 of **ANSI C63.4 - 2003**.
- 2.5 All the support peripherals are connect to the other LISN.
- 2.6 Cables and peripherals were moved to find the maximum emission levels for each frequency.

3 TEST SETUP

3.1 Typical : Setup Of Conducted Test

ELECTRICAL AND ELECTRONIC EQUIPMENT IN THE RANGE OF 9kHz TO 40 GHz

ANSI
C63.4-2003

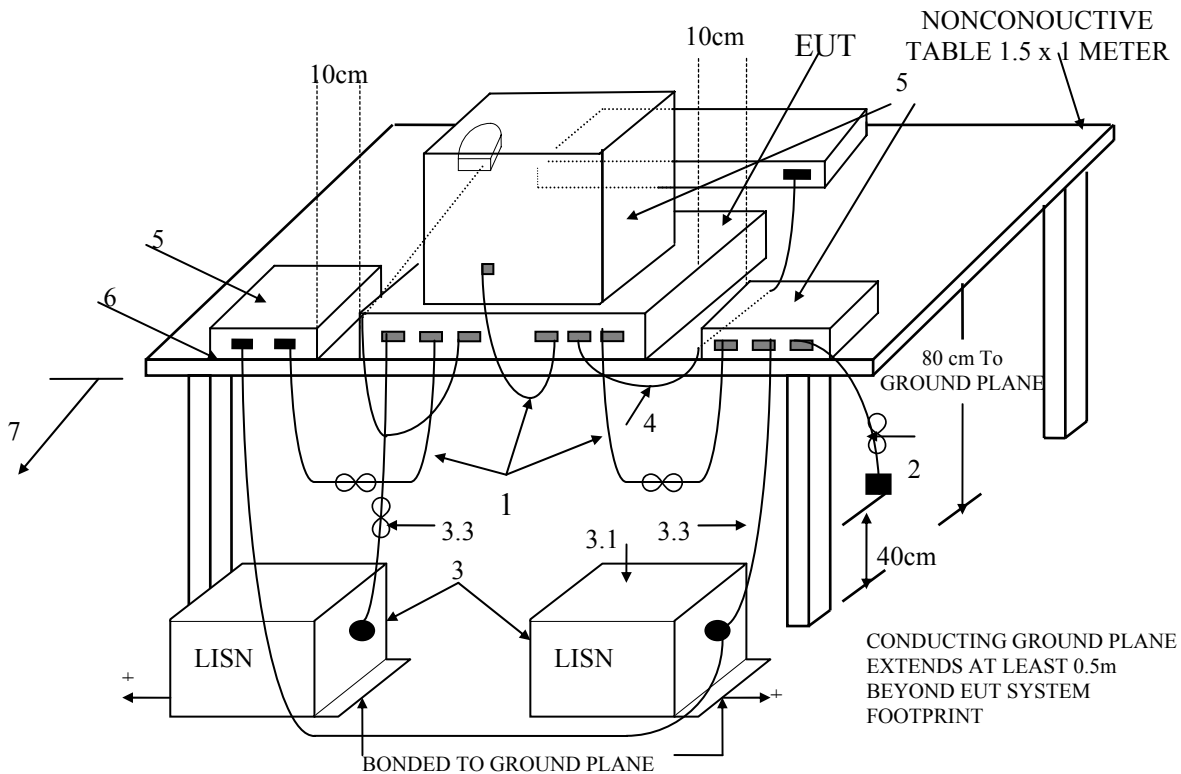

+LISNs may have to be moved to the side to meet 3.3 below.

(Details for setup configuration, please refer to appendix A.)

LEGEND:

1. Interconnecting cables that hang closer than 40 cm to the ground plane shall be folded back and forth forming a bundle 30 to 40 cm long, hanging approximately in the middle between ground plane and table.
2. I/O cables that are connected to a peripheral shall be bundled in center. The end of the cable may be terminated if required using correct terminating impedance. The total length shall not exceed 1m.
3. EUT connected to one LISN. Unused LISN connectors shall be terminated in 50 Ω. LISN can be placed on top of, or immediately beneath, ground plane.
 - 3.1 All other equipment powered from second LISN.
 - 3.2 Multiple outlet strip can be used for multiple power cords of non-EUT equipment.
 - 3.3 LISN at least 80 cm from nearest part of EUT chassis.
4. Cables of hand-operated devices, such as keyboards, mice, etc., have to be placed as close as possible to the host.
5. Non-EUT components being tested.
6. Rear of EUT, including peripherals, shall be all aligned and flush with rear of tabletop.
7. Rear of tabletop shall be 40 cm removed from a vertical conducting plane that is bonded to the floor ground plane (see 5.2).

**Test Configuration
Tabletop Equipment Conducted Emission**

3.2 Block Diagram Of Conducted Test

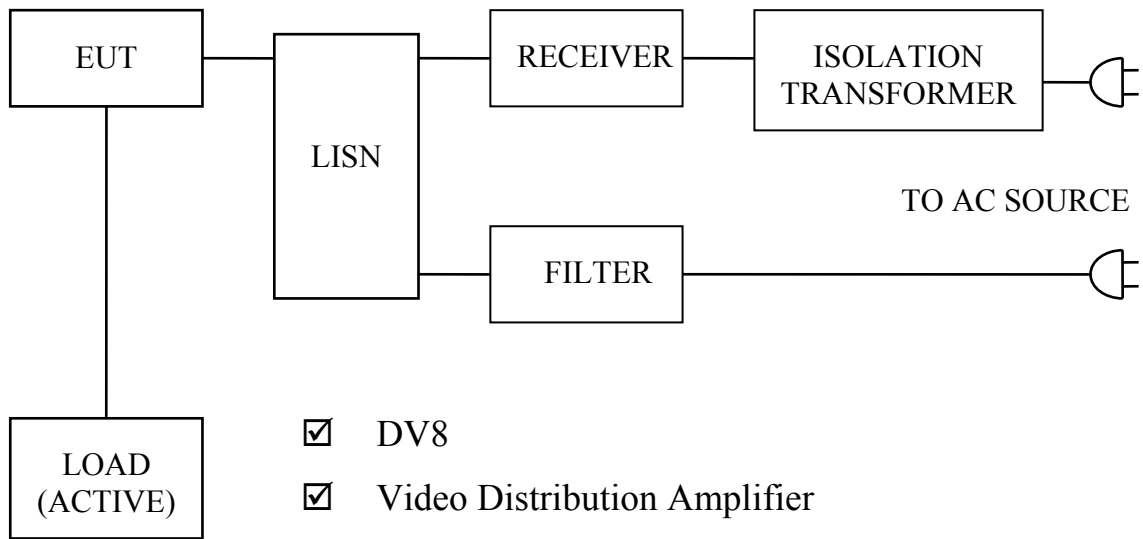

- DV8
- Video Distribution Amplifier
- Video Amplifier
- Power Center
- CAT5 AV Multimedia Transmission
- Terminator
- TV
- Adapter
- Video Distributor

4 CONFIGURATION OF THE EUT

The EUT was configured according to **ANSI C63.4 - 2003 & CISPR 22 - 1997**. All I/O ports were connected to the appropriate peripherals. All peripherals and cables are listed below (including internal device) :

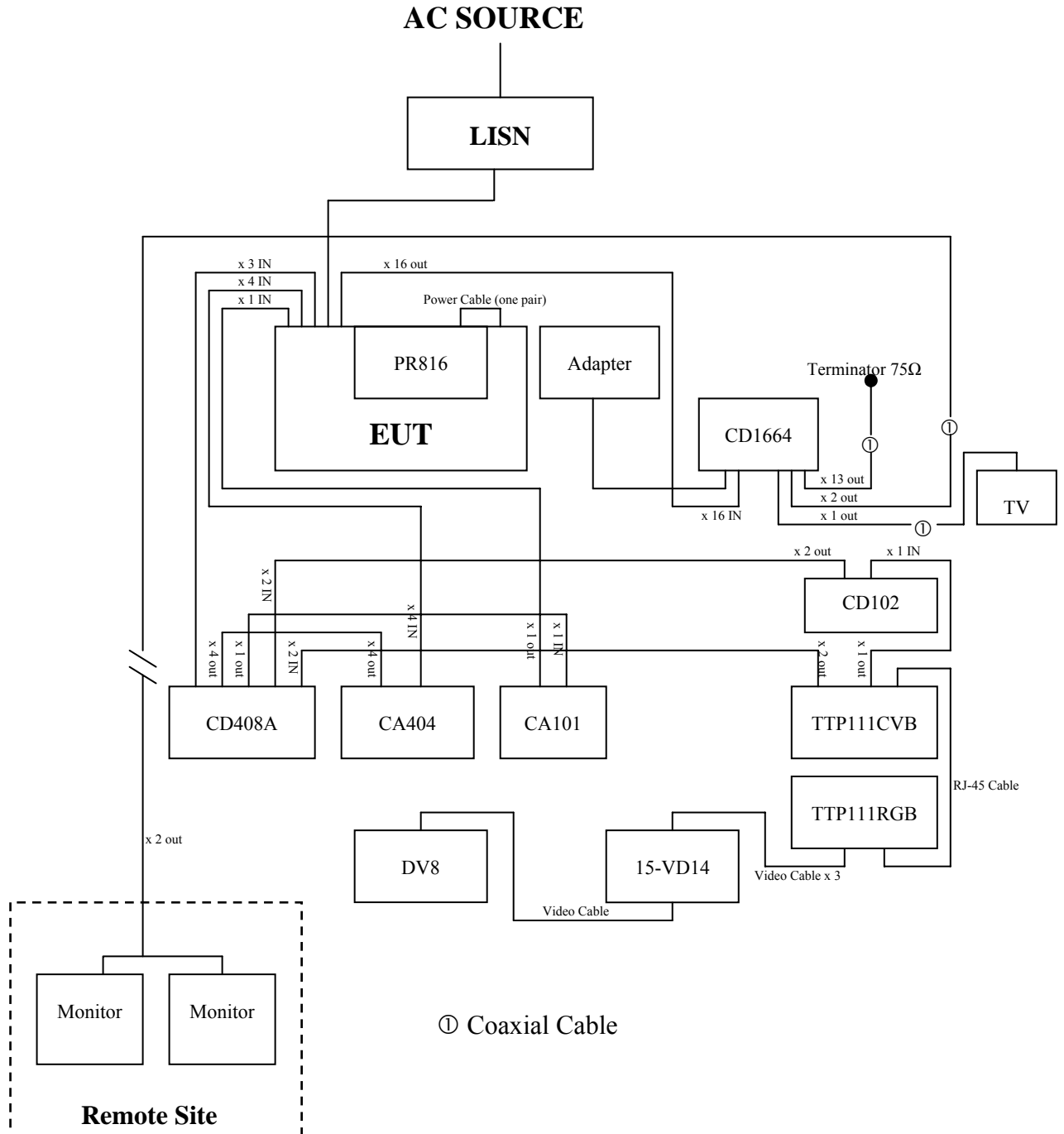

Figure 1

4.1 EUT

EUT Type : Proto Type Engineer Type Mass Production
 Condition when received : Good Damage : _____
 Device : Video Distribution Amplifier
 Applicant : SMART CABLING & TRANSMISSION CORP.
 Manufacturer : SMART CABLING & TRANSMISSION CORP.
 Model Number : CD8XXX
 Serial Number : N/A
 FCC ID : N/A
 Video Input Port x 8 : Metal Type Connector
 Video Output Port x 16 : Metal Type Connector
 Power Cord (AC) : Un-Shielded, 1.8 m, 2 pin
 Power Cord (DC) : Un-Shielded, 0.2 m, 2 pin
 Power Supply Type : Form Power center

4.2 PERIPHERALS

DV8

Manufacturer : SONY
 Model Number : DCR-PC110
 Serial Number : 1158142
 FCC ID : FCC DoC
 Data Cable : Shielded, 1.8 m, Connected to the coaxial port
 Power Cord : N/A



Video Distribution Amplifier

Manufacturer : SMART CABLING & TRANSMISSION CORP.
Model Number : CD1664
Serial Number : N/A
FCC ID : N/A
Data Cable x 16 : Shielded, 1.0 m, Connected to the Video Output Port
Power Cord : Un-Shielded, 1.8 m

Video Amplifier

Manufacturer : SMART CABLING & TRANSMISSION CORP.
Model Number : CA404
Serial Number : N/A
FCC ID : N/A
Data Cable x 4 : Shielded, 1.0 m, Connected to the Video Input Port
Power Cord : Un-Shielded, 1.8 m

Video Amplifier

Manufacturer : SMART CABLING & TRANSMISSION CORP.
Model Number : CA101
Serial Number : N/A
FCC ID : N/A
Data Cable : Shielded, 1.0 m, Connected to the Video Input Port
Power Cord : Un-Shielded, 1.8 m



Video Distribution Amplifier

Manufacturer : SMART CABLING & TRANSMISSION CORP.
Model Number : CD408A
Serial Number : N/A
FCC ID : N/A
Data Cable x 3 : Shielded, 1.0 m, Connected to the Video Input Port
Power Cord : Un-Shielded, 1.8 m

Video Distribution Amplifier

Manufacturer : SMART CABLING & TRANSMISSION CORP.
Model Number : CD102
Serial Number : N/A
FCC ID : N/A
Data Cable : Shielded, 1.0 m, Connected to the coaxial port
Power Cord : Un-Shielded, 1.8 m

Power Center

Manufacturer : SMART CABLING & TRANSMISSION CORP.
Model Number : PR816
Serial Number : N/A
FCC ID : N/A
Data Cable : N/A
Power Cord (AC) : Un-Shielded, 1.8 m
Power Cord (DC) : Un-Shielded, 0.2 m



CAT5 AV Multimedia Transmission

Manufacturer : SMART CABLING & TRANSMISSION CORP.
Model Number : TTP111RGB
Serial Number : N/A
FCC ID : N/A
Data Cable : Shielded, 1.0 m, Connected to the coaxial port
Power Cord : N/A

CAT5 AV Multimedia Transmission

Manufacturer : SMART CABLING & TRANSMISSION CORP.
Model Number : TTP111CVB
Serial Number : N/A
FCC ID : N/A
Data Cable : Shielded, 1.0 m, Connected to the coaxial port
Power Cord : N/A

Terminator

Manufacturer : HomeTek
Model Number : 75Ω
Serial Number : N/A
FCC ID : N/A
Data Cable : Shielded, 1.8 m, Connected to the coaxial port
Power Cord : N/A



TV

Manufacturer : TCL
Model Number : 1419A
Serial Number : N/A
FCC ID : N/A
Data Cable : Shielded, 1.8 m, Connected to the coaxial port
Power Cord : Un-Shielded, 1.8 m

Video Distributor

Manufacturer : SMART CABLING & TRANSMISSION CORP.
Model Number : 15-VD14
Serial Number : N/A
FCC ID : N/A
Data Cable : Shielded, 1.8 m, Connected to the coaxial port
Power Cord : Un-Shielded, 1.8 m

Adapter

Manufacturer : YUH NIAN
Model Number : HPA-501242U3 A2
Serial Number : N/A
FCC ID : N/A
Data Cable : N/A
Power Cord (AC) : Un-Shielded, 1.8 m
Power Cord (DC) : Shielded, 1.0 m



Monitor x 2 (Remote Site)

Manufacturer : SMART CABLING & TRANSMISSION CORP.

Model Number : MT14A

Serial Number : N/A

FCC ID : N/A

Data Cable : Shielded, 10 m, Connected to the coaxial port

Power Cord : Un-Shielded, 1.8 m

4.3 REMARK : N/A

5 EUT OPERATING CONDITION

- 5.1 The frequency of the EUT is none.
- 5.2 Configure the EUT according to the **ANSI C63.4 - 2003 & CISPR 22 - 1997**.
- 5.3 The operation condition of EUT, Please refer to section 4.
- 5.4 Support unit 1 represent Video Distributor(15-VD14).
Support unit 2 represent CAT5 AV Multimedia Transmission(TTP111RGB).
Support unit 3 represent Video Distribution Amplifier(CD102).
Support unit 4 represent Video Distribution Amplifier(CD408A).
Support unit 5 represent Video Amplifier(CA404).
Support unit 6 represent Video Amplifier(CA101).
Support unit 7 represent CAT5 AV Multimedia Transmission(TTP111CVB).
Support unit 8 represent Video Distribution Amplifier(CD1664).
- 5.5 DV gives color Bar signal to Support unit 1 via Video Port.
- 5.6 Support unit 1 is video distributors with one video input to three video output and transmits the signal to Support unit 2 via three video ports.
- 5.7 Support unit 2 transforms three video signals(input) into CAT 5 signal(output) then Support unit 2 transmits CAT 5 signal to Support unit 7 via one CAT 5 UTP cable.
- 5.8 Support unit 7 transforms CAT 5 signal(input) into three video signals(output) then Support unit 7 transmits video signal to Support unit 3 via one coaxial cable and Support unit 4 via two coaxial cable.
- 5.9 Support unit 3 is video distributors with one video input to two video output and transmits the signal to Support unit 4 via two video ports.
- 5.10 Support unit 4 receives four video signal through Support unit 7 and Support unit 3, then it transforms four video signals(input) into eight video signals(output).
- 5.11 Support unit 4 transmits four video signals to Support unit 5 via four coaxial cables.
- 5.12 Support unit 4 transmits one video signal to Support unit 6 via one coaxial cable.
- 5.13 Support unit 4 transmits three video signals to EUT via three coaxial cables.
- 5.14 Support unit 5 receives four video signals through Support unit 4 then it transmits and amplifies four video signals(input) to EUT via coaxial cables.
- 5.15 Support unit 6 receives video signal through Support unit 4 then it transmits and amplifies video signal(input) to EUT via coaxial cable.
- 5.16 EUT receives video signal through Support unit 4, Support unit 5 and Support unit 6.
- 5.17 EUT is video distributors with eight video input to sixteen video output and transmits the signals to Support unit 8 via coaxial cables.
- 5.18 Support unit 8 is video distributors with sixteen video inputs to sixty-four video outputs and transmits one signal to TV via coaxial cables and two signals to remote side (two Monitor) via 10m coaxial cable.
- 5.19 TV displays Color Bar.
- 5.20 Thirteen ports of Support unit 8 connects with terminator (75ohm).
- 5.21 The other ports are verified that they are not high incidence of EMC characteristic.
- 5.22 Measure the emission noise.
- 5.23 The photos of conducted test configuration, please refer to appendix A.**

6 LIMIT OF CONDUCTED POWER LINE EMISSION CLASS B

Frequency Range	Quasi Peak	Average
0.15 ~ 0.5 MHz	66 - 56 dBuV	56 - 46 dBuV
0.5 ~ 5 MHz	56 dBuV	46 dBuV
5 ~ 30 MHz	60 dBuV	50 dBuV

6.1 In the above table, the tighter limit applies at the band edges.

7 RESULT OF CONDUCTED POWER LINE TEST

7.1 The frequency range from 0.15 MHz to 30 MHz was investigated. All readings are quasi-peak values and average.

7.2 IF bandwidth : 9 kHz, Meas Time : 1 sec.

7.3 Temperature : 26 °C, Humidity : 54 % RH.

7.4 Deviations from the test standards and rules : None

7.5 The conducted test result were gained by following procedures :

Level = Reading Level + Insertion Loss of LISN + Cable Loss

(All calculation were done by ESHS30 EMI test receiver.)

7.6 Result : **PASSED**

8 CONDUCTED POWER LINE TEST DATA (PAGE 1)

HomeTek EMC LAB. TEL :886-2-22608375

15 Jun 2006 18:54

CONDUCTED EMISSIONS

EUT: Video Distribution Amplifier
 Manuf: 5F020
 Op Cond: LINE 1
 Operator: CHAD
 Test Spec: FOR CISPR22 CLASS B
 Comment: 110V/60Hz
 CD816
 Result File: 5f02011b.dat : CD816

Prescan Measurement: Detectors: X PK / + AV
 Meas Time: see scan settings
 Subranges: 16
 Acc Margin: 55 dB

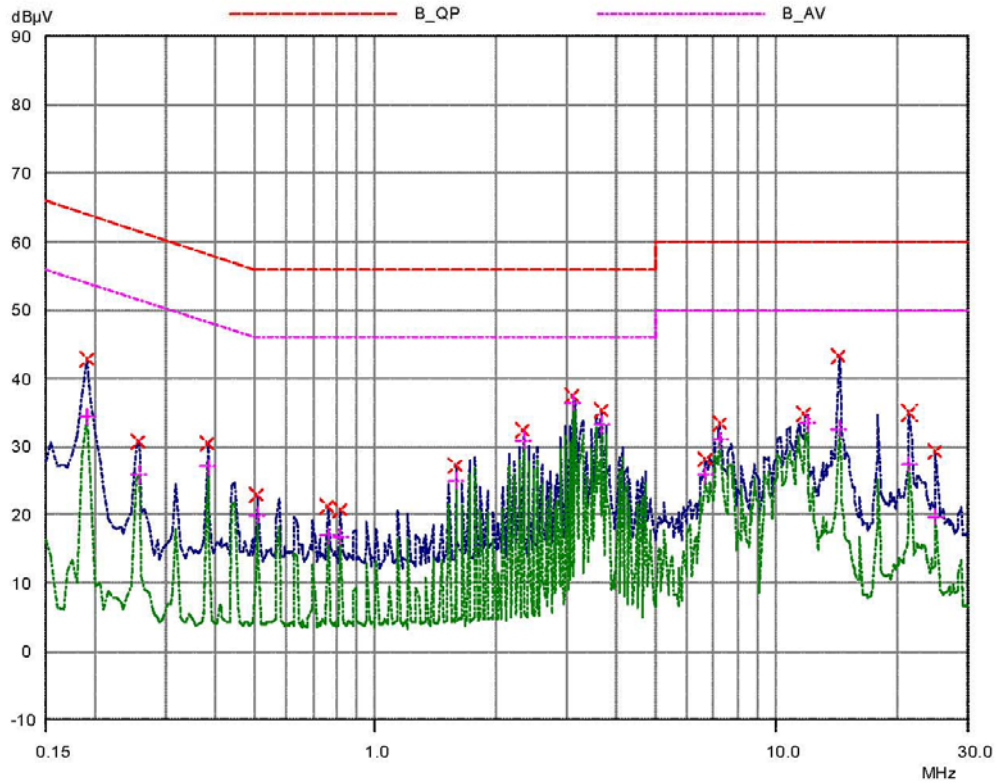



9 CONDUCTED POWER LINE TEST DATA (PAGE 2)

HomeTek EMC LAB. TEL :886-2-22608375

15 Jun 2006 18:54

CONDUCTED EMISSIONS

EUT: Video Distribution Amplifier
 Manuf: 5F020
 Op Cond: LINE 1
 Operator: CHAD
 Test Spec: FOR CISPR22 CLASS B
 Comment: 110V/60Hz
 CD816
 Result File: 5f02011b.dat : CD816

Prescan Measurement: Detectors: X PK / + AV
 Meas Time: see scan settings
 Subranges: 16
 Acc Margin: 55 dB

Peak Search Results

Frequency MHz	PK Level dBµV	PK Limit dBµV	PK Delta dB
0.19	42.92	64.04	21.12
0.255	30.86	61.59	30.73
0.38	30.60	58.28	27.68
0.505	22.82	56.00	33.18
0.76	21.11	56.00	34.89
0.82	20.73	56.00	35.27
1.58	27.12	56.00	28.88
2.34	32.50	56.00	23.50
3.1	37.61	56.00	18.39
3.67	35.37	56.00	20.63
6.64	28.10	60.00	31.90
7.21	33.42	60.00	26.58
11.76	34.90	60.00	25.10
14.3	43.41	60.00	16.59
21.46	35.05	60.00	24.95
25.07	29.37	60.00	30.63

Frequency MHz	AV Level dBµV	AV Limit dBµV	AV Delta dB
0.19	34.49	54.04	19.55
0.255	25.91	51.59	25.68
0.38	27.03	48.28	21.25
0.505	19.99	46.00	26.01
0.76	16.89	46.00	29.11
0.82	16.82	46.00	29.18
1.58	24.99	46.00	21.01
2.34	31.04	46.00	14.96
3.1	36.55	46.00	9.45
3.67	33.34	46.00	12.66
6.64	25.87	50.00	24.13
7.21	31.11	50.00	18.89
11.89	33.48	50.00	16.52
14.35	32.67	50.00	17.33
21.46	27.39	50.00	22.61
25.04	19.70	50.00	30.30

* limit exceeded

10 CONDUCTED POWER LINE TEST DATA (PAGE 3)

HomeTek EMC LAB. TEL :886-2-22608375

15 Jun 2006 18:59

CONDUCTED EMISSIONS

EUT: Video Distribution Amplifier
 Manuf: 5F020
 Op Cond: LINE 2
 Operator: CHAD
 Test Spec: FOR CISPR22 CLASS B
 Comment: 110V/60Hz
 CD816
 Result File: 5f02021b.dat : CD816

Prescan Measurement: Detectors: X PK / + AV
 Meas Time: see scan settings
 Subranges: 16
 Acc Margin: 55 dB

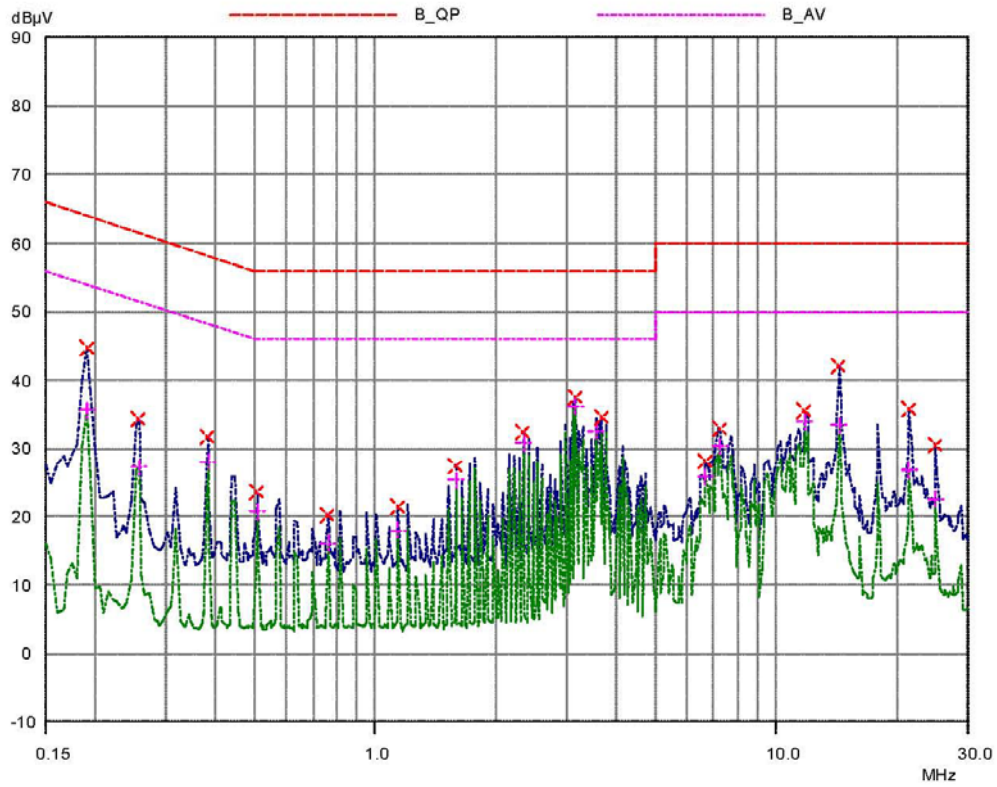



11 CONDUCTED POWER LINE TEST DATA (PAGE 4)

HomeTek EMC LAB. TEL :886-2-22608375

15 Jun 2006 18:59

CONDUCTED EMISSIONS

EUT: Video Distribution Amplifier
 Manuf: 5F020
 Op Cond: LINE 2
 Operator: CHAD
 Test Spec: FOR CISPR22 CLASS B
 Comment: 110V/60Hz
 CD816
 Result File: 5f02021b.dat : CD816

Prescan Measurement: Detectors: X PK / + AV
 Meas Time: see scan settings
 Subranges: 16
 Acc Margin: 55 dB

Peak Search Results

Frequency MHz	PK Level dBµV	PK Limit dBµV	PK Delta dB
0.19	44.82	64.04	19.22
0.255	34.41	61.59	27.18
0.38	31.78	58.28	26.50
0.505	23.60	56.00	32.40
0.76	20.34	56.00	35.66
1.14	21.52	56.00	34.48
1.58	27.48	56.00	28.52
2.34	32.58	56.00	23.42
3.16	37.45	56.00	18.55
3.67	34.61	56.00	21.39
6.64	28.10	60.00	31.90
7.27	33.06	60.00	26.94
11.76	35.58	60.00	24.42
14.3	42.13	60.00	17.87
21.46	35.94	60.00	24.06
25.07	30.51	60.00	29.49

Frequency MHz	AV Level dBµV	AV Limit dBµV	AV Delta dB
0.19	35.68	54.04	18.36
0.255	27.29	51.59	24.30
0.38	28.15	48.28	20.13
0.505	20.75	46.00	25.25
0.76	16.07	46.00	29.93
1.14	18.00	46.00	28.00
1.58	25.32	46.00	20.68
2.34	30.89	46.00	15.11
3.16	36.34	46.00	9.66
3.54	32.69	46.00	13.31
6.64	25.82	50.00	24.18
7.21	30.36	50.00	19.64
11.76	34.03	50.00	15.97
14.35	33.56	50.00	16.44
21.46	26.87	50.00	23.13
25.04	22.58	50.00	27.42

* limit exceeded

RADIATED EMISSION TEST

1 TEST INSTRUMENTS & FACILITIES

The following test Instruments was used during the radiated emission test :

Item	Instruments /facilities	Specification	Manufacturer	Model # / S/N#	Date of Cal.
1	OPEN AREA TEST SITE	<input checked="" type="checkbox"/> OATS 3			JUL/2005
2	EMI TEST RECEIVER	20Hz ~ 26.5GHz	ROHDE & SCHWARZ	ESMI 845442/006	FEB/2006
3	PRE-AMPLIFIER	9KHz ~ 3000MHz	ADVANTEST	BB525C 90081001	OCT/2005
4	ANTENNA (BI-LOG)	25MHz ~ 2GHz	SCHAFFNER	CBL6112B S/N : 2614	JUN/2006
5	Attenuation	50Ω/6dB	JYE BAO	FAT-N (M-F) 001	JUL/2005
6	Cable	10m	SUHNER	RG214/U OS3-003	DEC/2005
7	Cable	14m	BELDEN	9913 OS3-001	DEC/2005
8	EMI 32 (software)	N/A	AUDIX	19991013-0923	N/A

Note : Items 1 ~ 7 were calibrated within period of 1 year.

2 TEST PROCEDURE

- 2.1 The EUT was test according to **ANSI C63.4 – 2003 Section 5.4, 5.5, 8.1, 8.2, 8.3 & CISPR 22 - 1997 & C18-01-11 (HomeTek test procedure)**.
- 2.2 The radiated test was performed at HomeTek Lab's Open Site III.
- 2.3 The frequency range from 30 MHz to 1 GHz, the measurement were made at 10 meters, with a BI-log antenna.

3 TEST SETUP

3.1 TEST SETUP OF OPEN SITE.

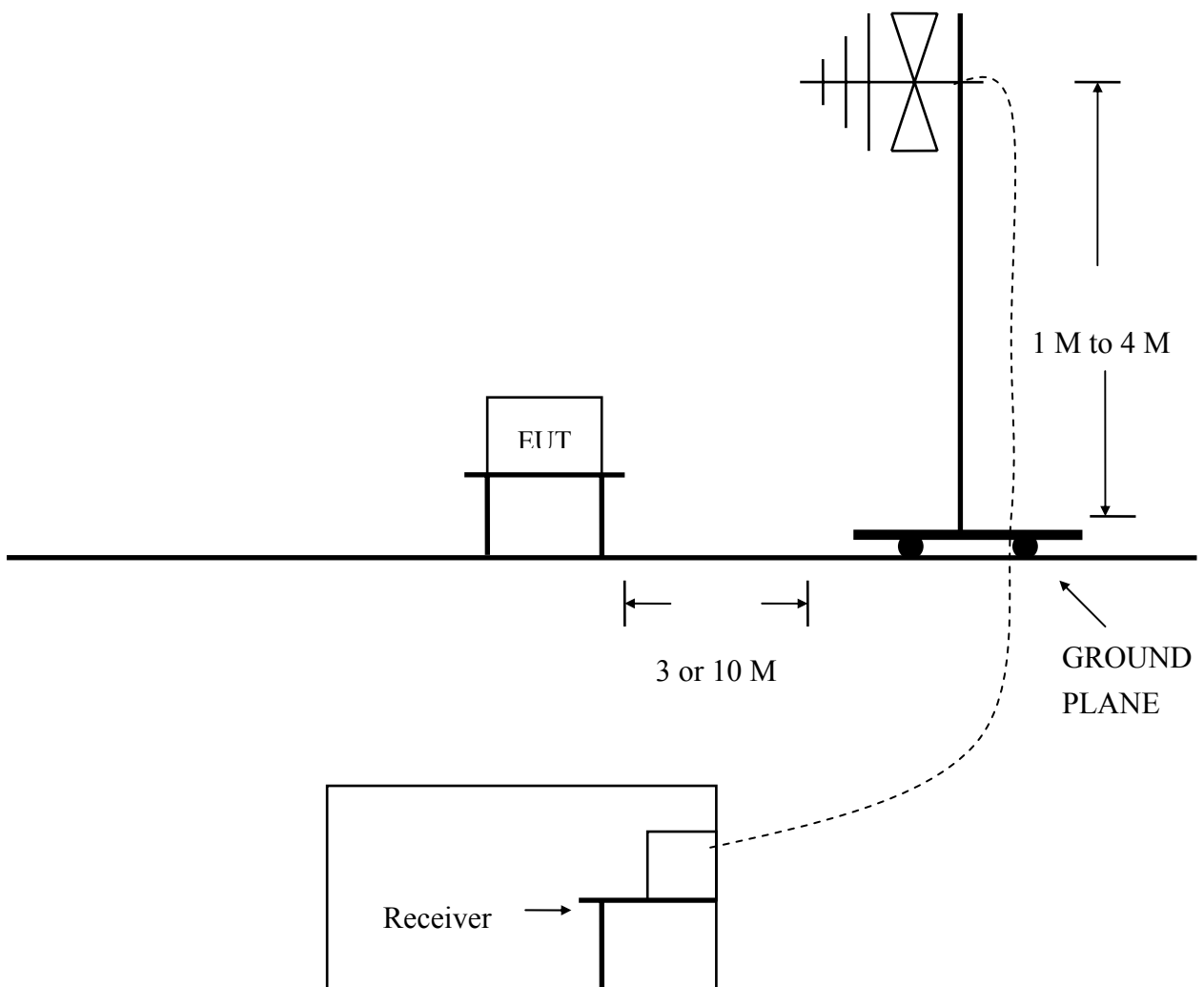

3.2 TEST SETUP OF EUT

ELECTRICAL AND ELECTRONIC EQUIPMENT IN THE RANGE OF 9kHz TO 40 GHz

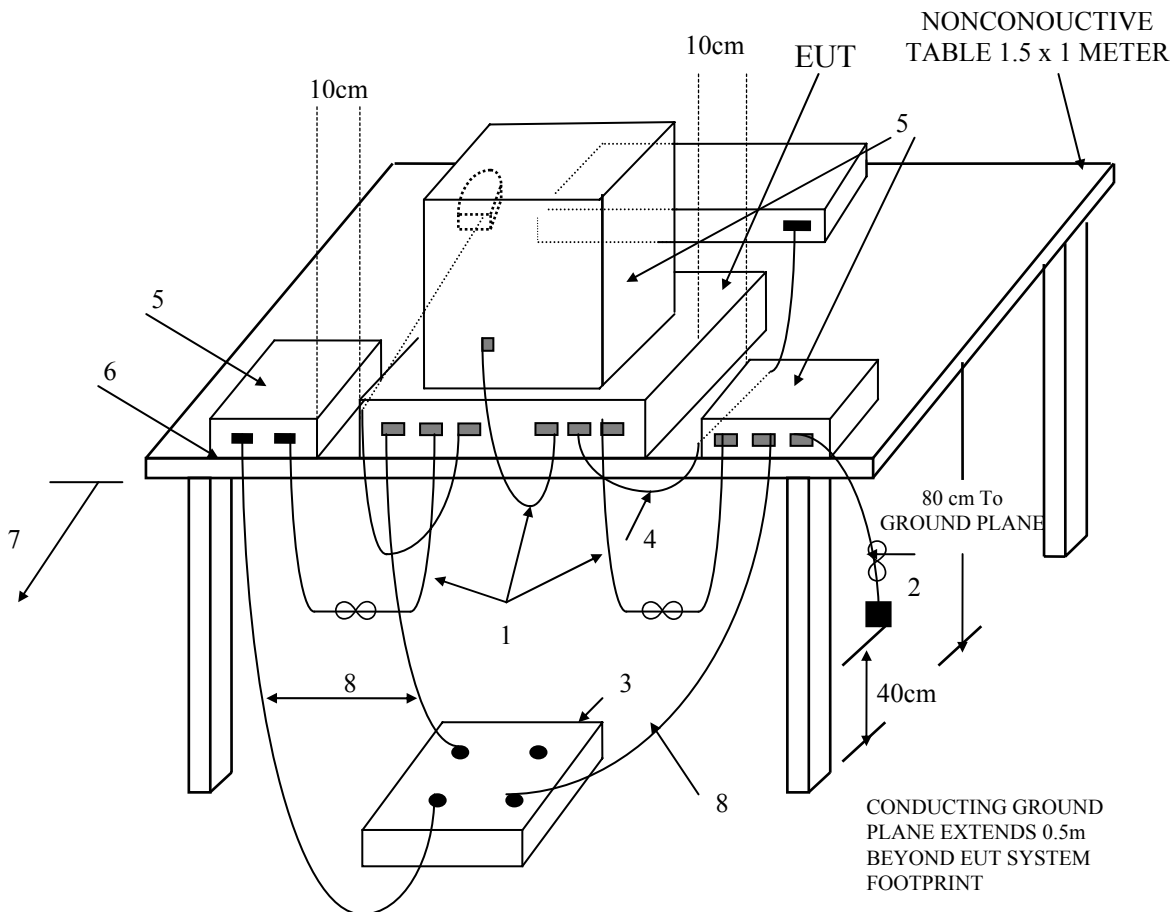
ANSI
C63.4-2003

(Details for setup configuration, please refer to appendix A.)

LEGEND:

1. Interconnecting cables that hang closer than 40 cm to the ground plane shall be folded back and forth forming a bundle 30 to 40 cm long, hanging approximately in the middle between ground plane and table.
2. I/O cables that are connected to a peripheral shall be bundled in center. The end of the cable may be terminated if required using correct terminating impedance. The total length shall not exceed 1m.
3. If LISNs are kept in the test setup for radiated emissions, it is preferred that they be installed under the ground plane with the receptacle flush with the ground plane.
4. Cables of hand-operated devices, such as keyboards, mice, etc., have to be placed as close as possible to the controller.
5. Non-EUT components of EUT system being tested.
6. The rear of all components of the system under test shall be located flush with the rear of the table.
7. No vertical conducting wall used.
8. Power cords drape to the floor and are routed over to receptacle.

Test Configuration

Tabletop Equipment Radiated Emission

4 CONFIGURATION OF THE EUT

Same as “Conducted Power Line test”, section 4

5 EUT OPERATING CONDITION

5.1 Same as “Conducted Power Line test”, section 5

5.2 The radiated emission in the frequency range from 30 MHz - 1000 MHz was test in a horizontal and vertical polarization at HomeTek Lab’s open site III.

5.3 The photos of radiated test configuration, please refer to appendix A.

6 LIMIT OF RADIATED EMISSION CLASS B

CISPR 22

Frequency (MHz)	Measurement Distance	Limit (dBuV/m)
30 - 230	10 (M)	30
230 - 1000	10 (M)	37

6.1 The tighter limit shall apply at the edge between two frequency bands.

6.2 Measurement distance in meters between the measuring instrument antenna and the closed point of any part of the EUT or peripherals.

7 RESULT OF RADIATED EMISSION TEST

- 7.1 The frequency range from 30 MHz to 1 GHz was investigated.
- 7.2 All readings below or equal 1 GHz are quasi-peak or peak values with resolution bandwidth of 120 KHz.
- 7.3 All readings above 1 GHz are average or peak values with resolution bandwidth of 1 MHz
- 7.4 The measurements were made at 10 meters of HomeTek Lab's open site III.
- 7.5 Temperature : 32 °C, Humidity : 47 % RH.
- 7.6 Deviation form the test standards and rules : None
- 7.7 The radiation emission result were gained by the following method :
Level = Reading Level + Probe Factor (Antenna Factor) + Cable Loss – Preamp Factor
Over Limit = Level – Limit Line
- 7.8 The radiated mission test was passed at minimum margin :
Vertical 82.02 MHz/ 24.85 dBuV/m, Antenna Height 1.5 Meter,
Turn Table 120 degree, The Model : CD816.
- 7.9 Result : **PASSED**



8 RADIATED EMISSION TEST DATA (PAGE 1)



HomeTek Technology Inc.

No 67-9, Shi-Men Rd., Tu-Chen City,
Taipei County, Taiwan R.O.C.
Tel: 02-22608375
Fax: 02-22748013

Data#: 1 File#: 5F020.EMI

Date: 2006-06-22 Time: 09:00:44

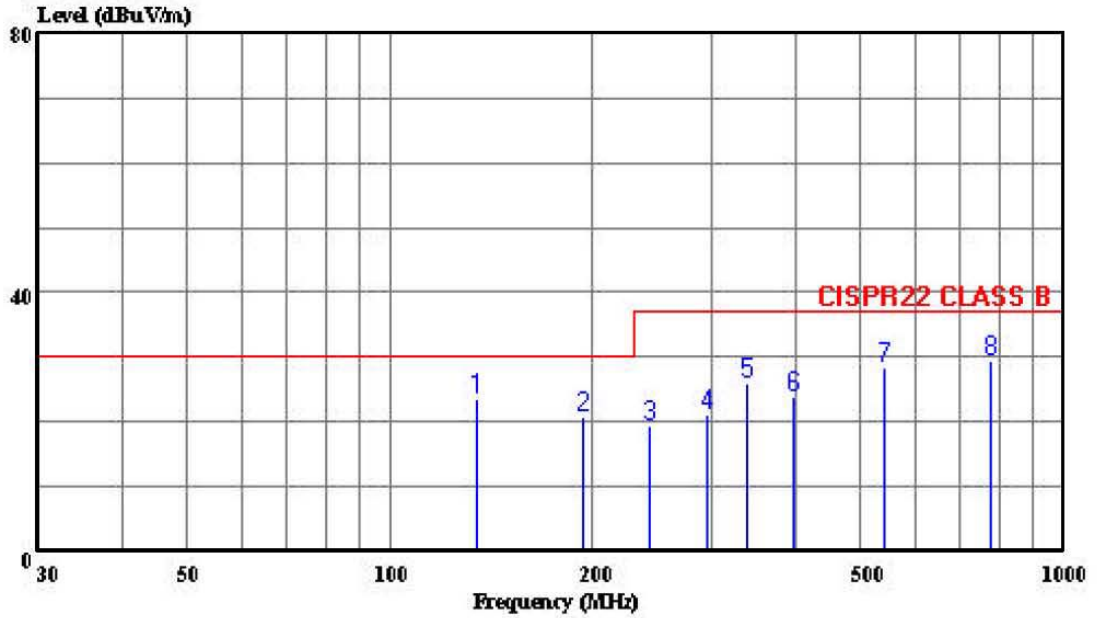

Trace:

Ref Trace:

Condition: CISPR22 CLASS B 10m CHASE 2614 060506 HORIZONTAL
eut : Video Distribution Amplifier
power: 110V/60Hz
memo : CD816

Page: 1

	Freq	Level	Limit	Over	ReadAntenna	Cable	Preamp		
	MHz	dBuV/m	dBuV/m	Limit	Level	Factor	Loss	Factor	Remark
				dB	dBuV	dB/m	dB	dB	
1	134.340	23.49	30.00	-6.51	36.18	11.45	1.58	25.72	Peak
2	192.913	20.83	30.00	-9.17	35.54	8.98	1.94	25.64	Peak
3	242.740	19.33	37.00	-17.67	31.10	11.66	2.14	25.58	Peak
4	296.000	20.97	37.00	-16.03	31.10	13.04	2.35	25.52	Peak
5	337.440	25.93	37.00	-11.07	34.73	14.09	2.56	25.44	Peak
6	397.940	23.89	37.00	-13.11	30.79	15.55	2.88	25.33	Peak
7	539.447	28.33	37.00	-8.67	31.22	18.44	3.47	24.80	Peak
8	779.333	29.44	37.00	-7.56	29.32	19.70	4.26	23.85	Peak



9 RADIATED EMISSION TEST DATA (PAGE 2)



HomeTek Technology Inc.

No 67-9, Shi-Men Rd., Tu-Chen City, Taipei County, Taiwan R.O.C. Tel:02-22608375 Fax:02-22748013

Data#: 2 File#: 5F020.EMI

Date: 2006-06-22 Time: 09:47:20

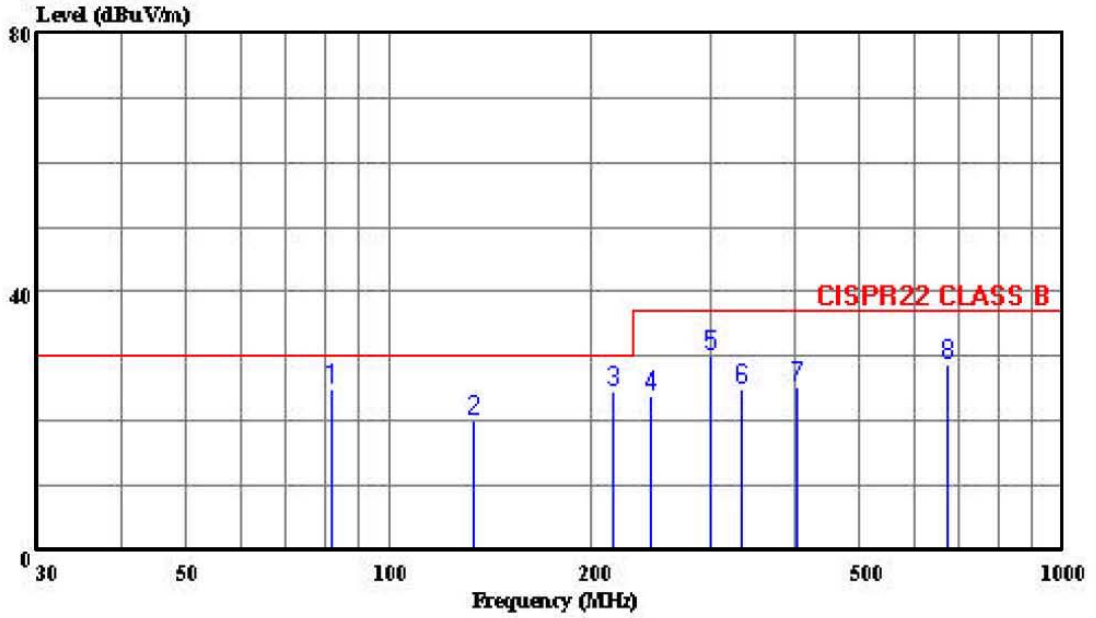

Trace:

Ref Trace:

Condition: CISPR22 CLASS B 10m CHASE 2614 060506 VERTICAL
eut : Video Distribution Amplifier
power: 110V/60Hz
memo : CD816

Page: 1

	Freq	Level	Limit	Over	ReadAntenna	Cable	Preamp		
	MHz	dBuV/m	dBuV/m	Limit	Level	Factor	Loss	Factor	Remark
				dB	dBuV	dB/m	dB	dB	
1	82.027	24.85	30.00	-5.15	41.89	7.57	1.22	25.83	Peak
2	133.500	20.08	30.00	-9.92	32.77	11.46	1.58	25.72	Peak
3	215.553	24.61	30.00	-5.39	39.08	9.10	2.04	25.61	Peak
4	244.007	23.77	37.00	-13.23	35.37	11.82	2.15	25.58	Peak
5	300.000	30.18	37.00	-6.82	40.21	13.13	2.37	25.52	Peak
6	333.527	24.94	37.00	-12.06	33.84	14.01	2.54	25.45	Peak
7	404.460	25.42	37.00	-11.58	32.14	15.68	2.91	25.31	Peak
8	674.887	28.89	37.00	-8.11	30.03	18.90	4.07	24.11	Peak

SAMPLE OF FCC DoC LABEL 1

This device complies with part 15 of the FCC Rules.
Operation is subject to the following two conditions: (1)
This device may not cause harmful interference. And (2)
this device must accept any interference received, including
interference that may cause undesired operation.

SAMPLE OF FCC DoC LABEL 2

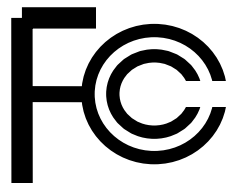

Trade Name
Model Number



HomeTek Technology Inc.

Appendix A

PHOTOS OF TEST CONFIGURATION

PHOTO OF CONDUCTED POWER LINE TEST

Model : CD816



Front View



Rear View

PHOTO OF RADIATED EMISSION TEST

Model : CD816



Front View



Rear View



HomeTek Technology Inc.

Appendix B

PHOTOS OF EUT

PHOTO OF EUT

Model : CD816



Full View of EUT

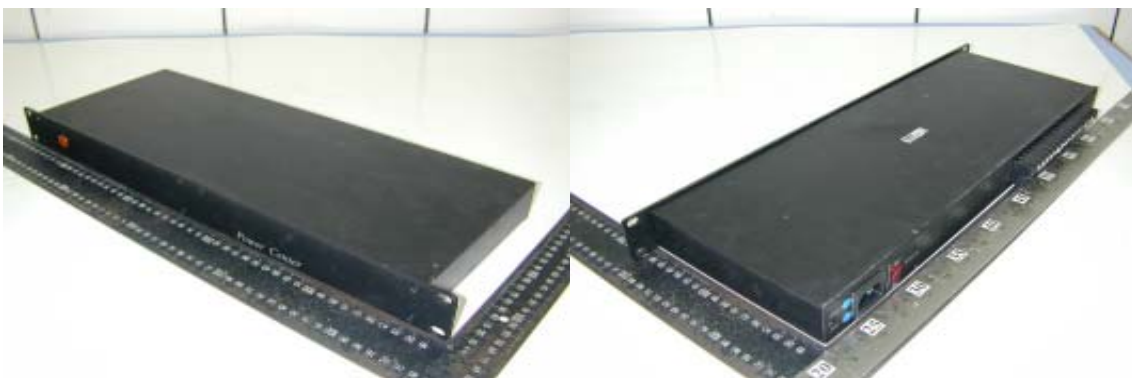

Full View of Support Unit

PHOTO OF EUT

Model : CD816

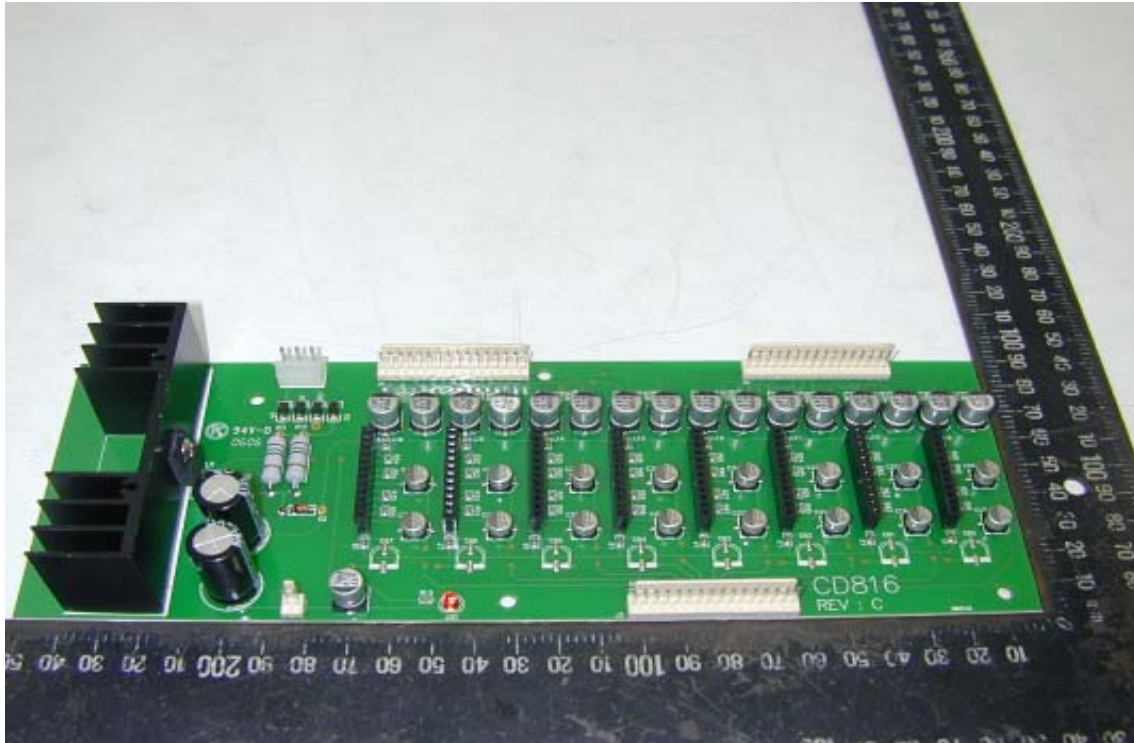

Component Side of Main Board 1

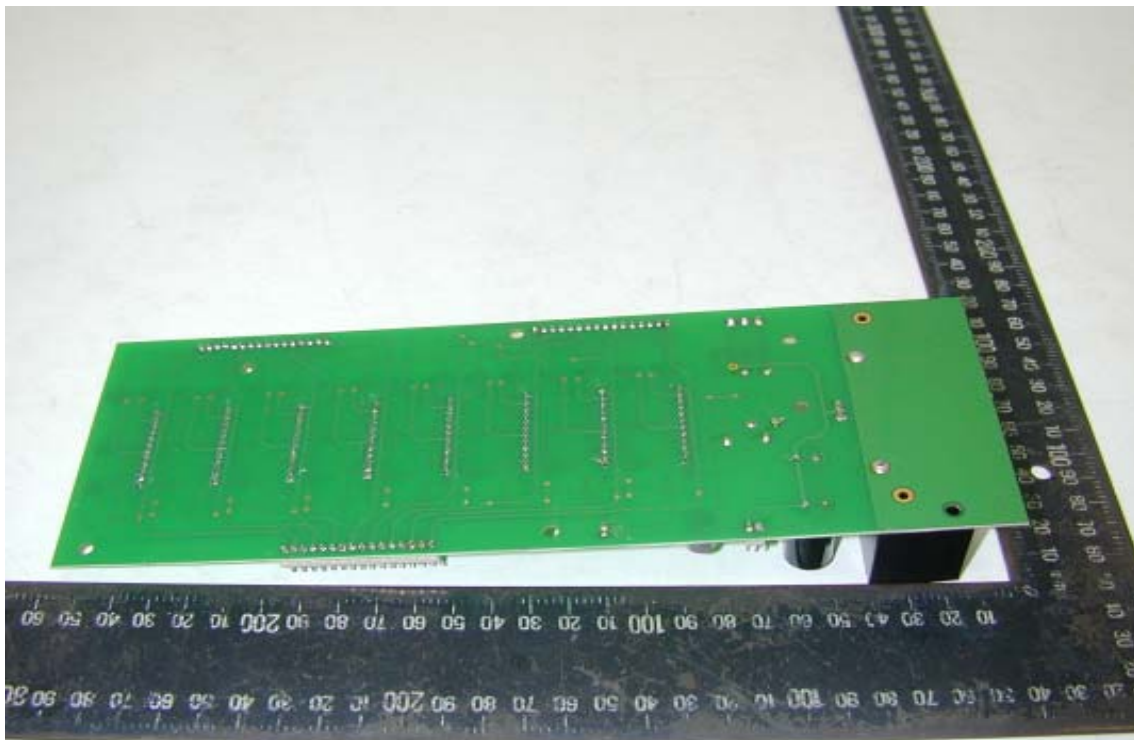

Solder Side of Main Board 1

PHOTO OF EUT

Model : CD816

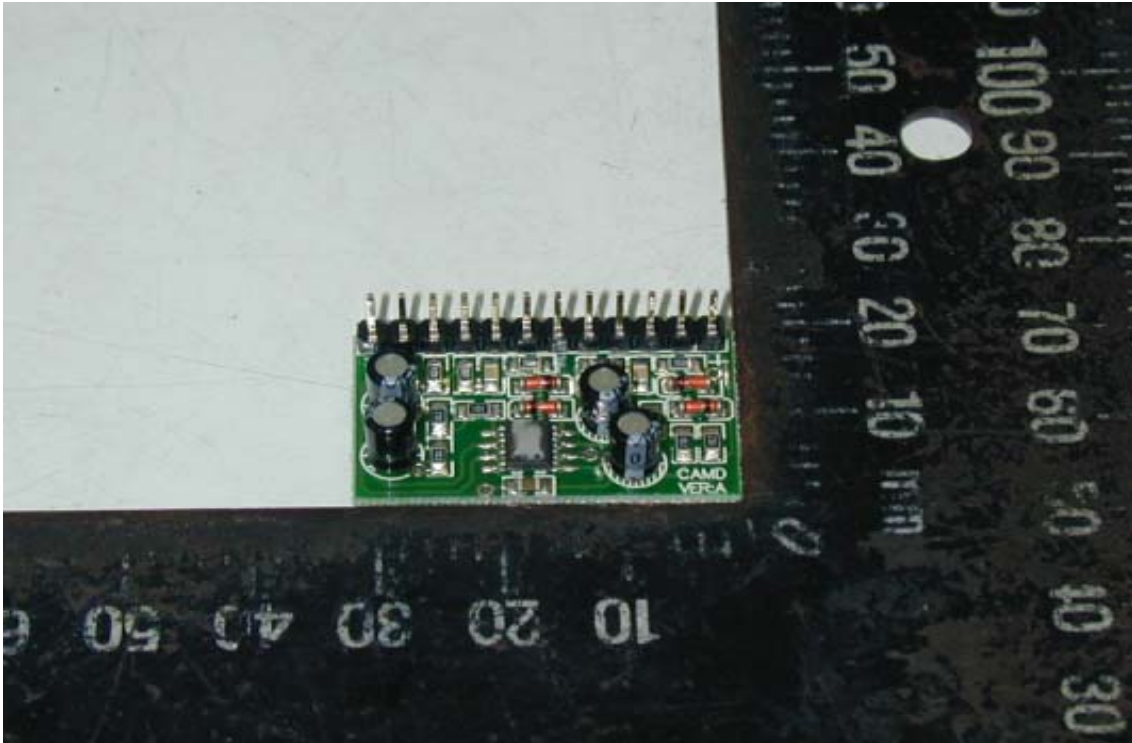

Component Side of Main Board 2

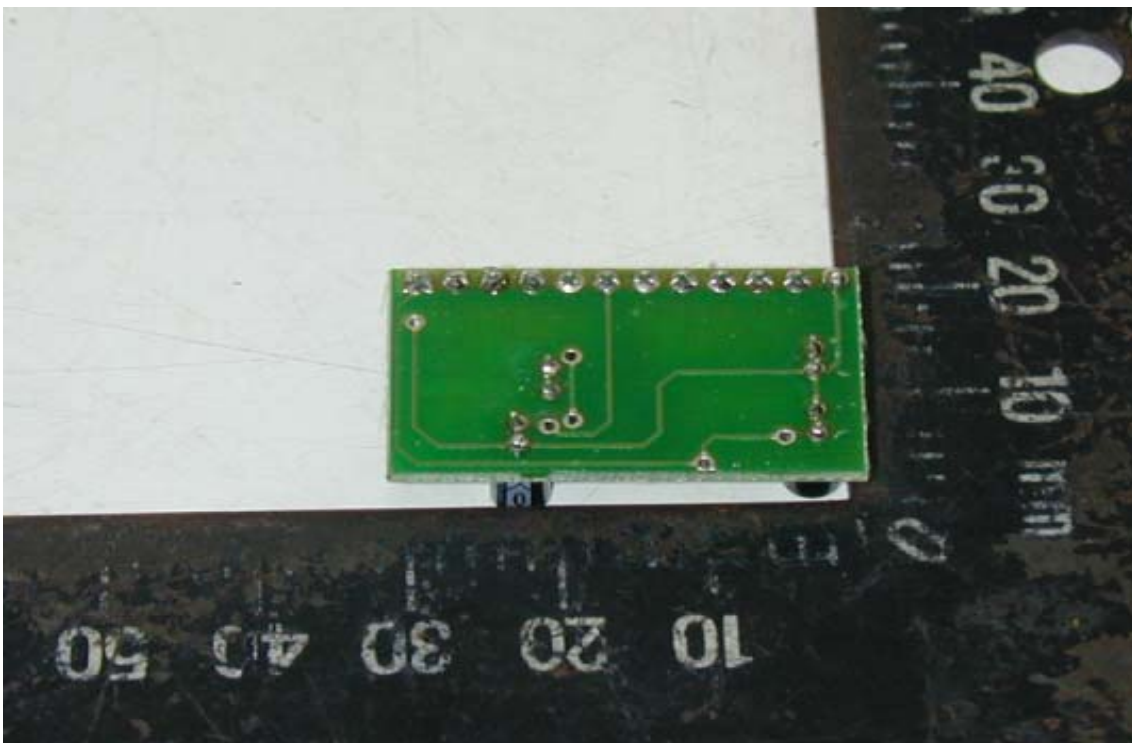

Solder Side of Main Board 2

PHOTO OF EUT

Model : CD816

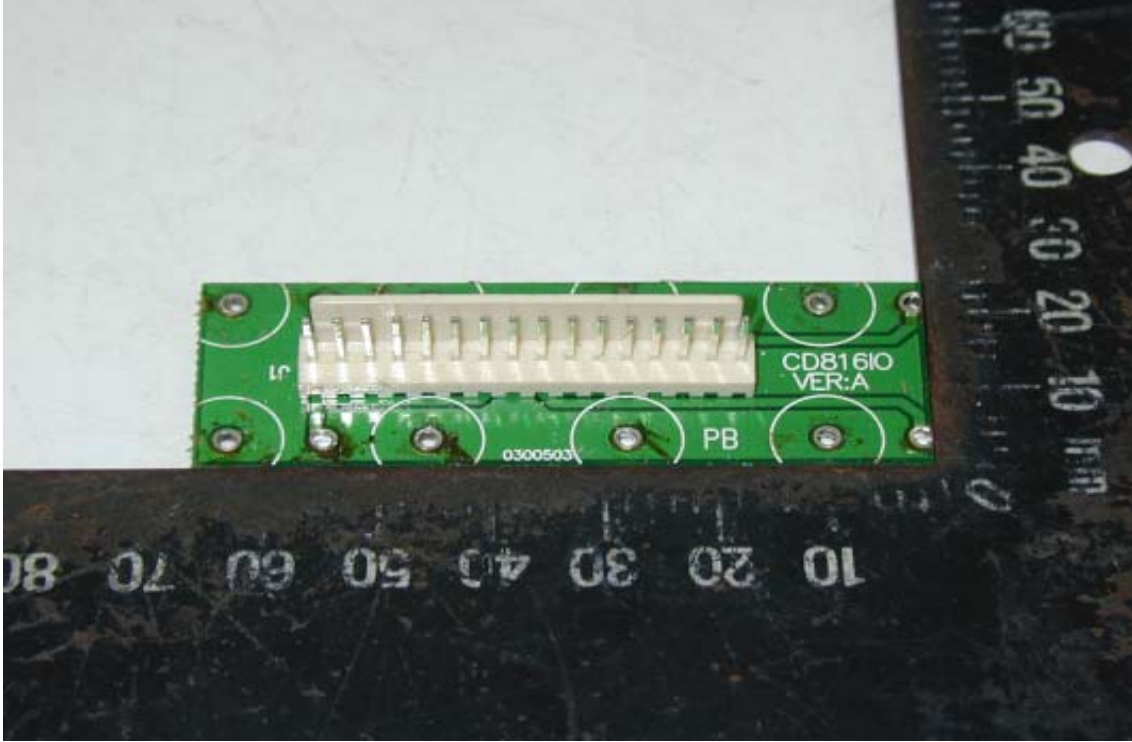

Component Side of Main Board 3

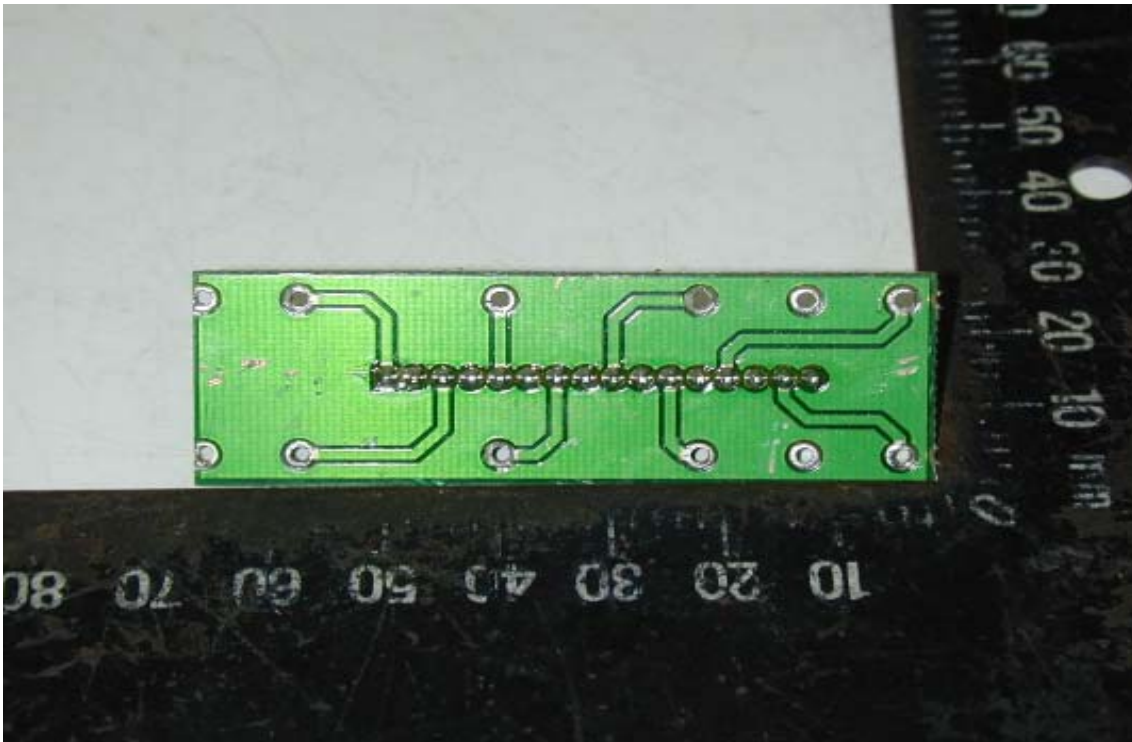

Solder Side of Main Board 3

Declaration of Conformity

Responsible Party Name :

Address :

Phone No :

Fax No :

Declares under our sole responsibility that the product

Product Name : Video Distribution Amplifier

Model No. : CD8XXX

to which this declaration relates is in conformity with the following standards or other normative documents

This device complies with Part 15 of the FCC Rules. Operation is subject to the following two conditions : (1) this device may not cause harmful interference, and (2) this device must accept any interference received, including interference that may cause undesired operation.

Representative Person's Name : _____

Signature : _____

Date : _____

United States Department of Commerce
National Institute of Standards and Technology



Certificate of Accreditation to ISO/IEC 17025:1999

NVLAP LAB CODE: 200331-0

HomeTek Technology Inc.

Taipei Shien 236
TAIWAN

*is recognized by the National Voluntary Laboratory Accreditation Program for conformance with criteria set forth in
NIST Handbook 150:2001 and all requirements of ISO/IEC Guide 17025:1999.
Accreditation is granted for specific services, listed on the Scope of Accreditation, for:*

ELECTROMAGNETIC COMPATIBILITY AND TELECOMMUNICATIONS

2005-10-01 through 2006-09-30

Effective dates



For the National Institute of Standards and Technology

A handwritten signature in black ink, appearing to read "N. P. Mark".



SCOPE OF ACCREDITATION TO ISO/IEC 17025:1999

HomeTek Technology Inc.
P.O Box: 13-131, Pan-Chiao City
No. 67-9 Shir Men Rd., Tu Chen City
Taipei Shien 236
TAIWAN
Mr. Grant Huang
Phone: 886-2-22608375 Fax: 886-2-22748013
E-Mail: hometek@ms15.hinet.net

ELECTROMAGNETIC COMPATIBILITY AND TELECOMMUNICATIONS

NVLAP LAB CODE 200331-0

NVLAP Code Designation / Description

Emissions Test Methods:

- 12/CIS14a EN 55014-1 (1993), A1 (1997), A2 (1999):
12/CIS14a2 BS EN 55014-1 (2001) with A1 and A2: Electromagnetic compatibility - Requiements for household appliances, electric tools and similar apparatus - Part 1: Emission
12/CIS14b1 AS/NZS CISPR 14-1 (2003): Electromagnetic Compatibility - Requirements for household appliances, electric tools and similar apparatus - Part 1: Emission
12/CIS14c CNS 13783-1: Electromagnetic Compatibility Requirements for household appliances, electric tools and similar apparatus - Part 1: Emissions
12/CIS14d IEC/CISPR 14-1 (2001) and A1 (2001): Electromagnetic Compatibility - Requirements for household appliances, electric tools and similar apparatus - Part 1: Emissions
12/CIS14x IEC/CISPR 14-1, Ed. 4 (2003): Electromagnetic Compatibility - Requirements for household appliances, electric tools and similar apparatus - Part 1: Emission
12/CIS22 IEC/CISPR 22 (1997) & EN 55022 (1998) + A1(2000): Limits and methods of measurement of radio disturbance characteristics of information technology equipment
12/CIS22a IEC/CISPR 22 (1993) and EN 55022 (1994): Limits and methods of measurement of radio disturbance characteristics of information technology equipment, Amendment 1 (1995) and Amendment 2 (1996)

2005-10-01 through 2006-09-30

Effective dates

Handwritten signature of Nian P. Mah

For the National Institute of Standards and Technology



**National Voluntary
Laboratory Accreditation Program**



**ELECTROMAGNETIC COMPATIBILITY
AND TELECOMMUNICATIONS**

NVLAP LAB CODE 200331-0

<i>NVLAP Code</i>	<i>Designation / Description</i>
12/CIS22b	CNS 13438 (1997): Limits and Methods of Measurement of Radio Interference Characteristics of Information Technology Equipment
12/CIS22c	IEC/CISPR 22, Fourth Edition (2003-04) & EN 55022 (1998): Information technology equipment - Radio disturbance characteristics - Limits and methods of measurement
12/FCC15b	ANSI C63.4 (2003) with FCC Method 47 CFR Part 15, Subpart B: Unintentional Radiators
12/T51a	AS/NZS CISPR 22 (2004): Information technology equipment - Radio disturbance characteristics - Limits and methods of measurement
12/VCCIa	VCCI: Agreement of Voluntary Control Council for Interference by Information Technology Equipment - Technical Requirements: V-3/2004.04

2005-10-01 through 2006-09-30

Effective dates

For the National Institute of Standards and Technology