

## HDMI (HDBaseT) Matrix Switcher Series

### ITEM NO.: HE04M 4 x 4 HDMI + HDBaseT Matrix Switcher

With the latest and more affordable HDBaseT technology extend HDMI sources up to 100M at 1080p or 1920x1200. HE04M HDMI 4 by 4 Matrix Switcher allows for effortless control of up to 4 devices through Ethernet Control, Android App Control, IR remote control, RS-232 and the front panel.



### HE04M 4 x 4 HDMI (HDBaseT) Matrix Switcher

- ◆ 4 x HDMI inputs, 4 x HDMI Outputs Matrix switcher
- ◆ Dual Output: local HDMI port and remote RJ45 HDBaseT™
- ◆ Work with HE02ER, HE02R receiver at each monitor up to 100 meters over CAT5e/6.
- ◆ Work with HE02EIR receiver at each monitor up to 70 meters over CAT6a cable.
- ◆ Three control option: Front panel button, IR remote control, RS232 through remote PC.
- ◆ Support local/remote IR control to select input/output.
- ◆ Built in RS232 console port to select input/output.
- ◆ **Built 1 in 4 out IR distributor function, allow the HE04M control each monitor and also could be using the IR remote control to select the input source from the monitor side.**
- ◆ **Built in Ethernet Control and Android App Control.**
- ◆ Uncompressed high definition video 1080p@60Hz 12 bit and 3D capable
- ◆ HDMI 1.4 video features supported, HDCP compliant.
- ◆ Built in 4 channel IR & RS232 extender (work with Receiver: HE02EIR, HE02ER,)
- ◆ Input/Output status could be displayed at front panel LCM & LED.
- ◆ **Optional Model:**  
RC04 : 4 x 4 Keypad remote control (select HE04M input/output)



### ◆ Optional CAT5E/CAT6 Receiver Model:

- HE02ER: 100m HDMI Receiver
- HE02R : 100m HDMI, bidirectional IR and RS232 Receiver
- HE02EIR: 70m HDMI and IR mono directional



## 1.0 HE04M Panel View:

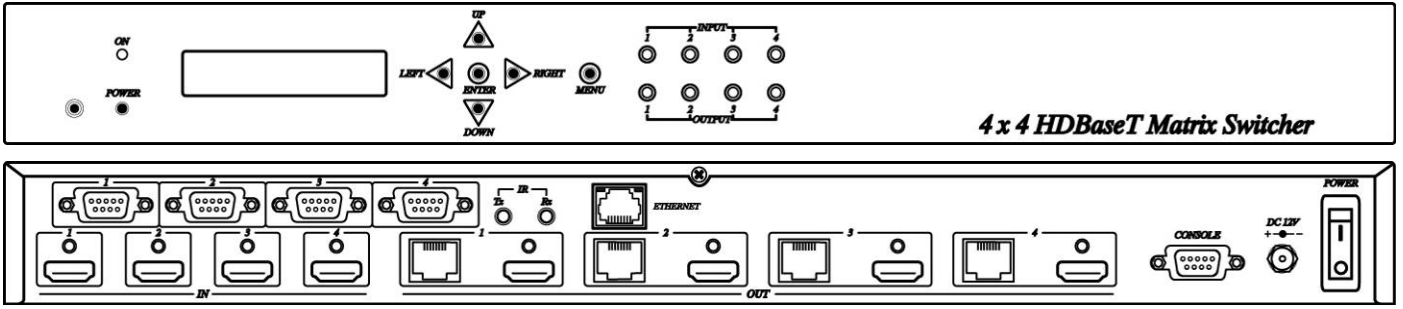

## 2.0 HE04M Connection View:

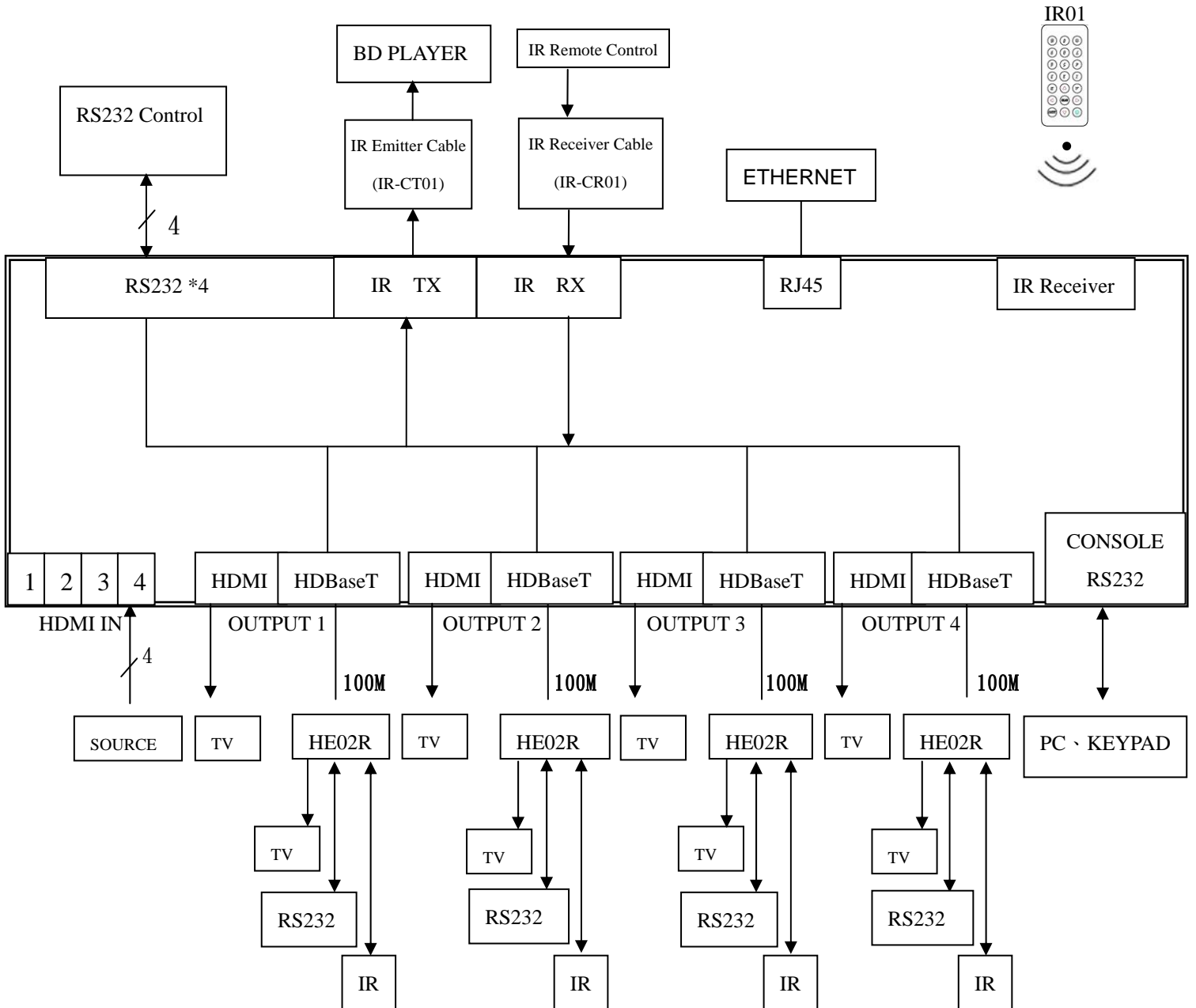

\* Under dual Output connection: local HDMI port or remote RJ45 termination  
 Once you link both HDMI & HDBaseT connection, the output will be effected HDMI port only.  
 For HDBaseT active output, you must disconnection HDMI output link.

## 3.0 Keypad and Leds

### 3.1 Back Panel Switch:

POWER	Light on	Power on
	Light off	Power off

### 3.2 Front LED Indication:

ON	BLUE	Power on
	RED	Standby
	LED off	Power Off
INPUT 1, 2, 3, 4	BLUE	Presence signal indication
	LED off	No signal incoming
OUTPUT 1, 2, 3, 4	BLUE	HDMI output indications
	RED	HDBaseT output indication
	LED off	Output unlink

### 3.3 Standby mode: The IR Remote only could control POWER on/off.

#### Front Button Function:

Power	Power on/standby
UP	up
DOWN	down
LEFT	left
RIGHT	right
ENTER	select confirm key
MENU	back to main menu

\*When the sub-menu setting changed, press the ENTER key to complete the setting. If no press ENTER key, then the setting will be failed.

### 3.4 LCM Panel Function:

#### 4X4 HDMI MATRIX: Power on Main Screen

When the power is on and the main screen appears, press the MENU key to enter the main menu

## Main MENU Option:

- \* SWITCH SETTING
  - RS232 SETTING
  - IR TX SETTING
  - IR RX SETTING
  - HDBaseT IR ID
  - MATRIX IR ID
  - ETHERNET
  - EDID
  - FIRMWARE VER.
  - KEYLOCK

## Operation:

- Press UP or DOWN key to move \* to select an item for setting and press ENTER key to enter into subpage.
- When the selected sub-page setting is completed, press the MENU button to return to the main page



## 4.0 LCM Main MENU Function Operation:

### 4.1 SWITCH SETTING : (Default: 1 2 3 4)

OUTPUT	1	2	3	4
INPUT	1	2	3	4

This function is used to switch the input/output port. Enter the SWITCH SETTING menu. Press the ENTER key, then the LCM second line INPUT will flash. Press LEFT or RIGHT button to select the output to be modified. Then press UP or Down button to select the input port. After that, press ENTER to confirm setting.

At HDBaseT remote port you could use IR01 remote control to do a quick input selection

①~④ represent select HDMI input ports 1~4. Press  or  to turn off the video output. (See cap. 4.5 HDBaseT IR ID)

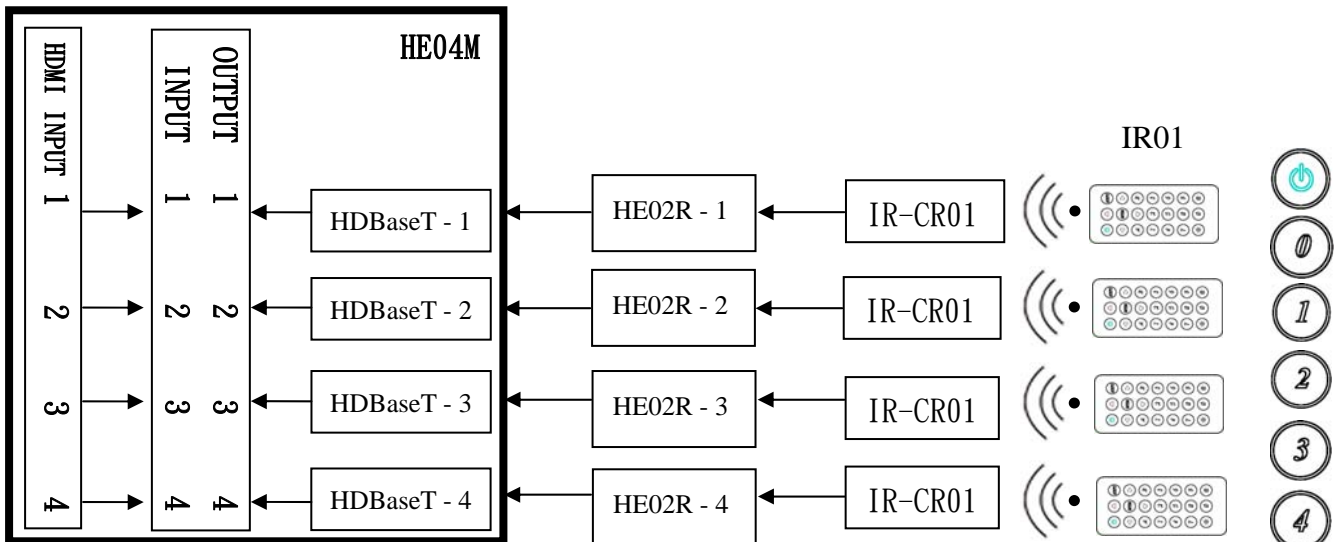

## 4.2 RS-232 SETTING : (Default: FIX MODE)

HDBaseT RS-232 extender function works in two mode. Enter RS-232 SETTING MENU, press ENTER. The \* will flash, then press UP or DOWN button to select FIX MODE or MATRIX MODE. Press ENTER key to confirm setting.

- ◆ FIX MODE is one to one transmission, RS-232 port 1 only work with HDBaseT port 1, RS-232 port 2 only work with HDBaseT port 2, and so on...

\* FIX MODE  
MATRIX MODE

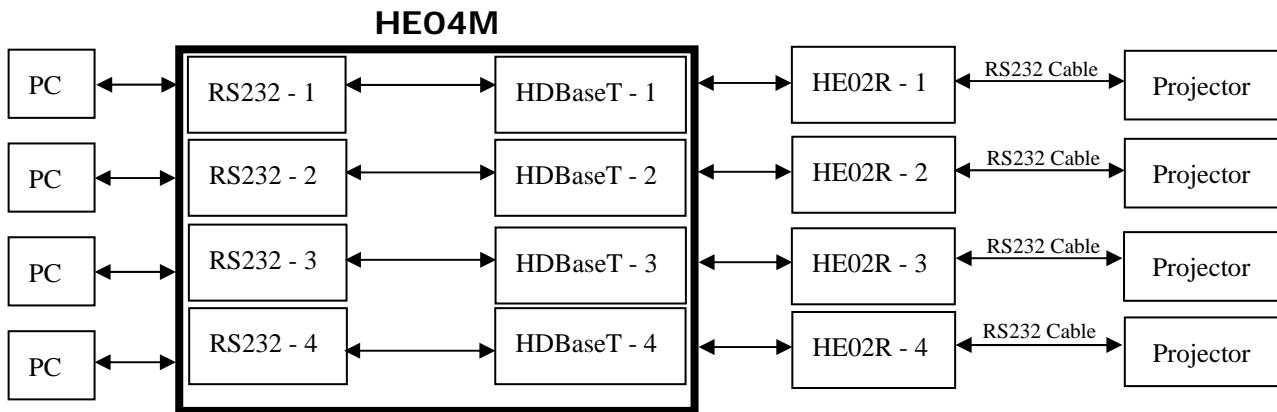

RS-232 SETTING : FIX MODE

- ◆ RS-232 MATRIX MODE is based on the Status of the Matrix. The RS-232 transmission will follow the HDMI switching. In the example below, RS-232 port 1 work with HDBaseT port 1, 2 and 3. RS-232 port 4 works with HDBaseT port 4

FIX MODE  
\* MATRIX MODE

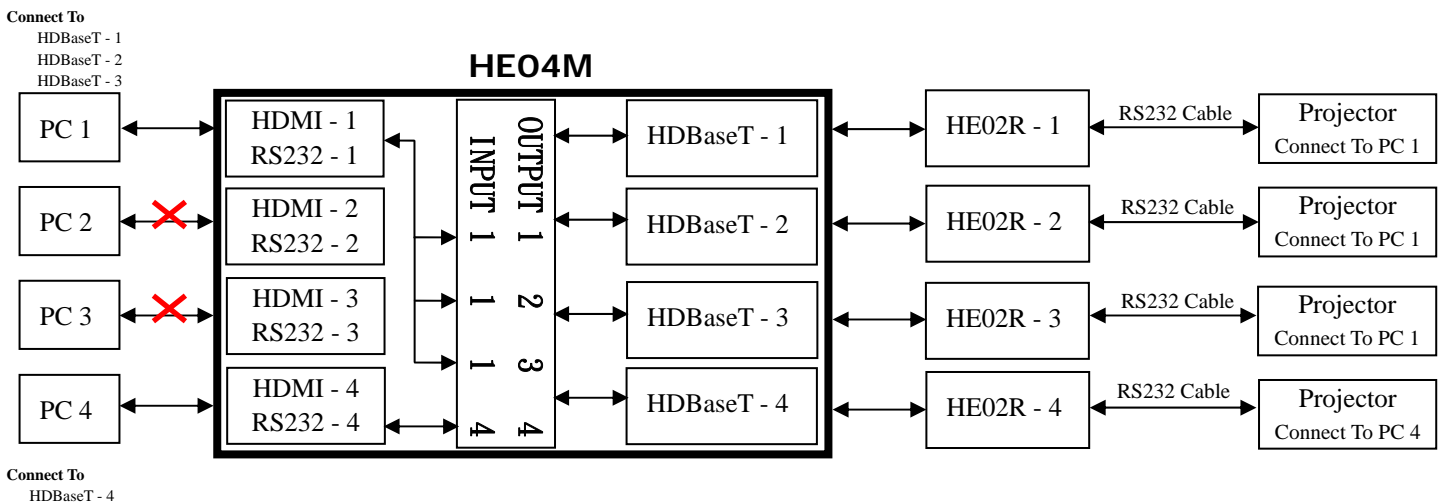

RS-232 SETTING : MATRIX MODE

**4.3 IR TX SETTING** (From matrix to remote locations): **(Default IR TX: 0 0 0 0)**

This function setup the IR signal whether from MATRIX, by IR Rx input jack, is sent to HDBaseT ports. Setting 0 the transmission is enabled, setting X transmission is off.

This is the typical application when the user wants to control from the matrix side the remote destination like a TV.

After entering IR TX SETTING menu, press ENTER. Then LCM second line of text will flash. Press RIGHT or LEFT button to select the IR TX output to be modified Press Press UP or DOWN button to select O or X. Then press ENTER to confirm setting.

HDBaseT	1	2	3	4
IR TX	0	X	0	X

**0 : on      X : off**

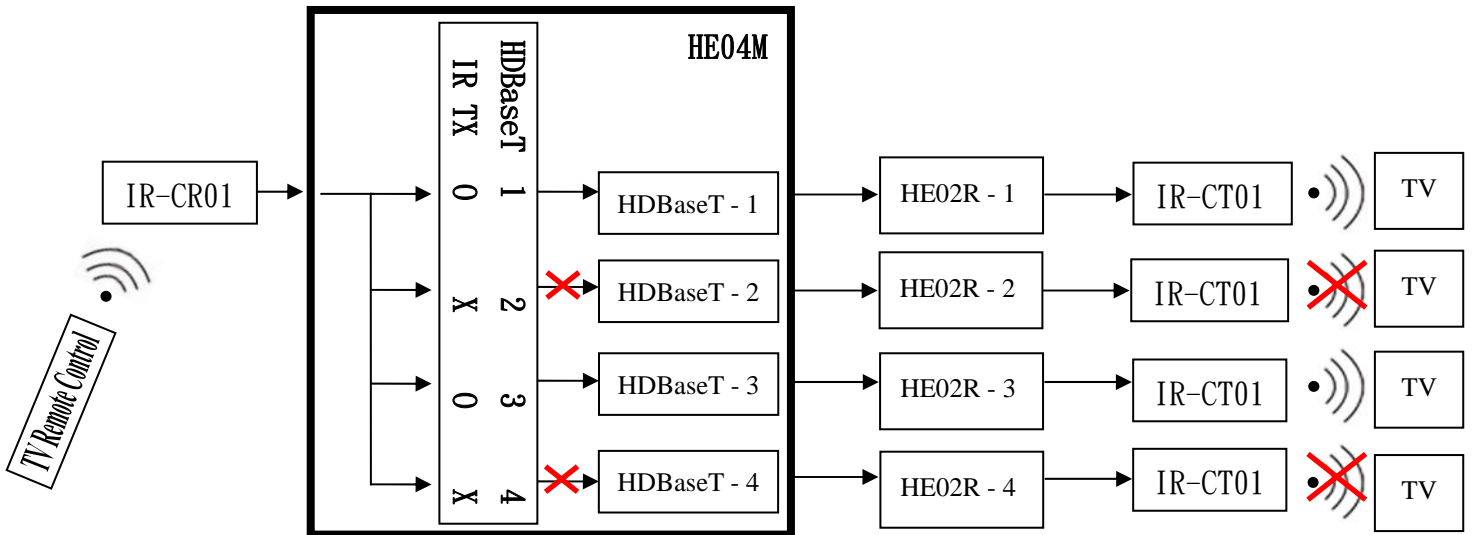

#### 4.4 IR RX SETTING : (Default IR RX: 0 0 0 0)

This function setup the IR signal whether from HDBaseT location is sent to MATRIX to control local device through the IR Tx output jack. Setting 0 the transmission is enabled, setting X transmission is off.

This is a typical application when the user wants to control from the remote location a source like a DVD player.

After entering IR RX SETTING menu, press ENTER. Then LCM second line of text will flash. Press RIGHT or LEFT button to select the IR RX input to be modified. Press UP or DOWN button to select 0 or X. Then press ENTER to confirm setting.

HDBaseT	1	2	3	4
IR RX	0	X	0	X

0 : on      X : off

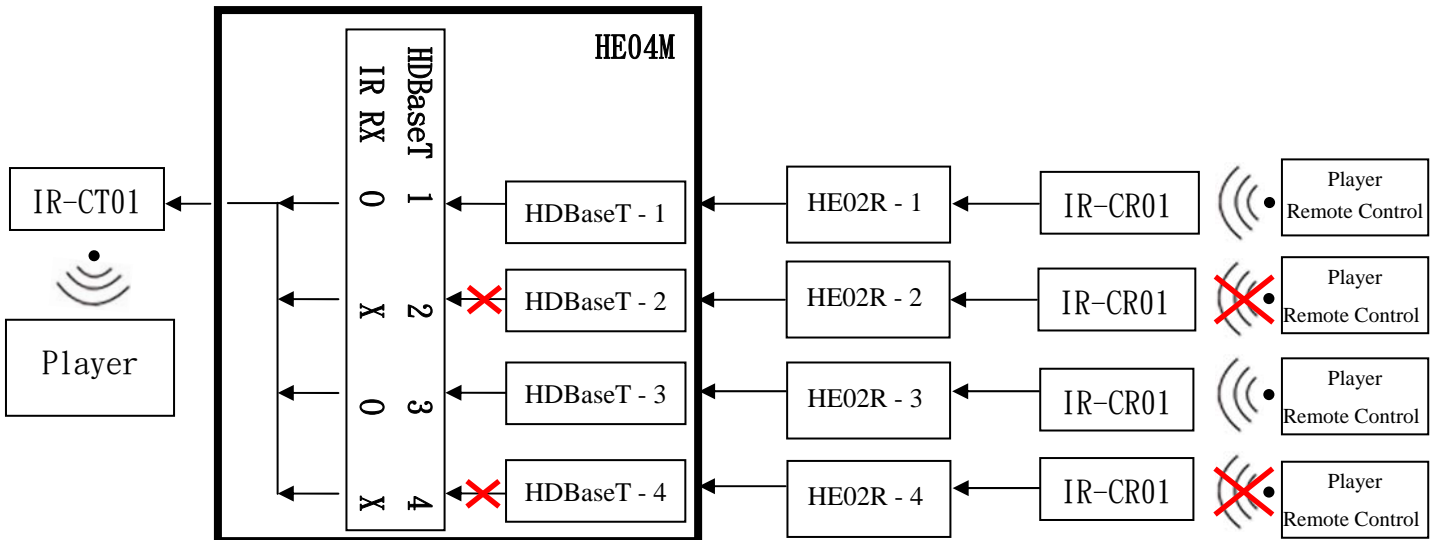

#### 4.5 HDBaseT IR ID : (Default IR ID: 0 1 2 3)

HDBaseT	1	2	3	4
IR ID	0	1	2	3

This function must be set to have different ID in order to avoid HDBaseT remote control IR01 conflicts with other devices remote control.

After entering HDBaseT IR ID menu, press ENTER. Then LCM second line of text will flash. Press RIGHT or LEFT button to select the IR ID input to be modified. Press UP or DOWN button to select the ID. Then press ENTER to confirm setting.

When you finish the HDBaseT IR ID setting, the HDBaseT remote controls IR01 must also be set with the **same ID** in order to perform the right operations. (See 5.2)

Remote IR ID setting mode: Press and hold the POWER button, then press the number button which can be set from 0 to 9, total 10 groups. (See 5.2)

These settings on IR01 remote control have to be done the first time you use the IR01 or when you change the batteries.

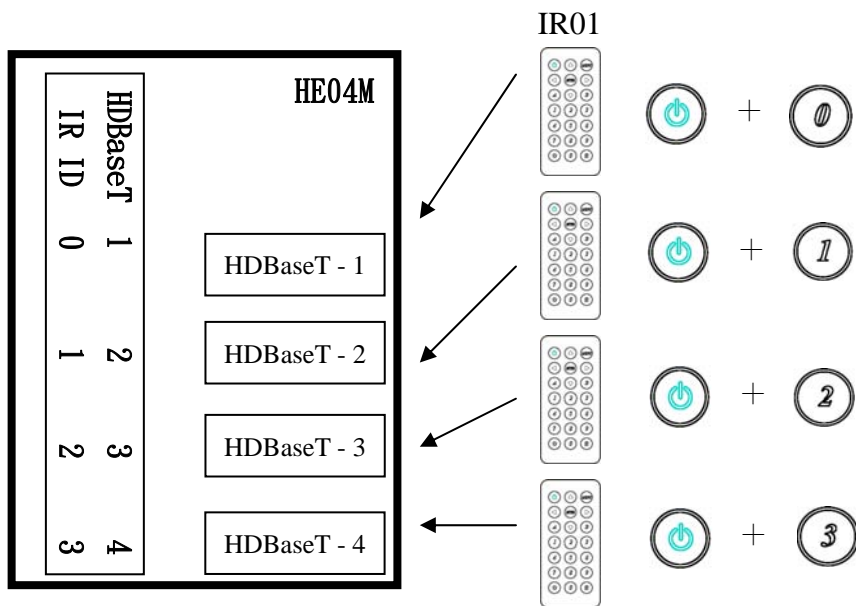

#### 4.6 MATRIX IR ID : (Default IR ID: 4)



This function must be set to match the Matrix remote control IR01 with the matrix itself. Conflicts with other devices remote control is therefore avoided.

After entering MATRIX IR ID menu, press ENTER, the LCM LINE 1 number will flash. Then Press UP or DOWN button to select the number, and then press ENTER to confirm.

When finish MATRIX IR ID setting, MATRIX remote control IR01 must also set the same ID in order to operation in normal.

When you finish the MATRIX IR ID setting, the remote control IR01 that will control locally the matrix, also is setted with the **same ID** in order to perform the right operations. (See 5.1)

Remote IR ID setting mode: Press and hold the POWER button, then press the number button which can be set from 0 to 9, total 10 groups. (See 5.1)

These settings on IR01 remote control have to be done the first time you use the IR01 or when you change the batteries.

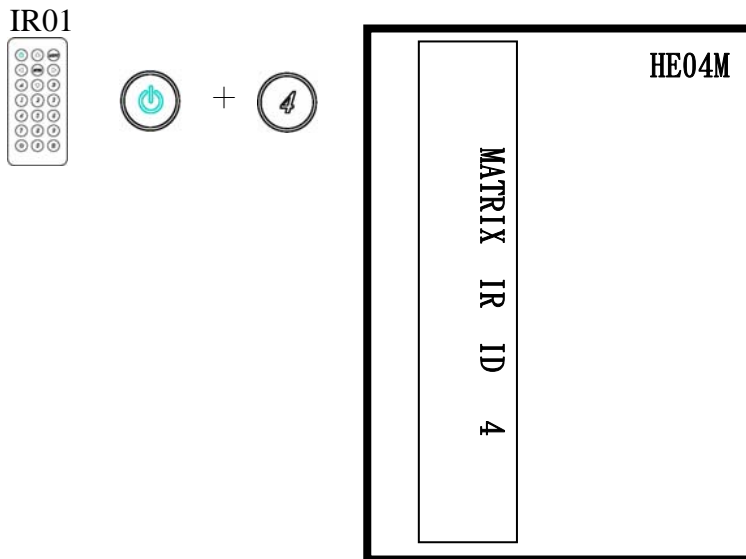

## 4.7 Ethernet

- \* IP Address
- Subnet Mask
- Gateway
- DHCP Client
- Media Type
- MAC Filter

IP Address: (Default: 192.168.0.200)

IP Address 192. 168. 0. 200
--------------------------------

This function can be setup MATRIX host intranet "IP Address", press the ENTER, the left-most number of second row will flash, then press the UP or DOWN button to change the numbers, , press LEFT or RIGHT to move to another location, the move to a position number will flash, press ENTER to complete the setting.

**Subnet Mask: (Default 255.255.255.0)**

Subnet Mask 255. 255. 255. 000
-----------------------------------

This function can be setup MATRIX host intranet "Subnet Mask", press the ENTER, the left-most number of second row will flash, then press the UP or DOWN button to change the numbers Press the ENTER, , press LEFT or RIGHT to move to another location, the move to a position number will flash, press ENTER to complete the setting.

Gateway: (Default 192.168.0.1)

Gateway 192.168. 0. 1
--------------------------

This function can be setup MATRIX host intranet "Gateway", press the ENTER, the left-most number of second row will flash, then press the UP or DOWN button to change the numbers Press the ENTER, , press LEFT or RIGHT to move to another location, the move to a position number will flash, press ENTER to complete the setting.

### DHCP Client: (Default Disable)

DHCP Client Disable
------------------------

When DHCP Clients setup at “Enable”, the MATRIX host will automatically get IP Address, Subnet Mask, Gateway, if setup at “Disable”, the MATRIX Host IP Address need go through “ ETHERNET” menu to set IP Address, Subnet Mask, Gateway, to press the ENTER, the second row will flash, then press the UP or DOWN to select DISABLE, ENABLE, then press ENTER to complete the setting.

### Media Type: (Default 100M)

Media Type 100M
--------------------

This function can be setup MATRIX host intranet “Media Type, press the ENTER, the second row will flash, then press the UP or DOWN button to select 10M, 100M, AUTO, press ENTER to complete the setting.

### MAC Filter : (Default Disable)

MAC Filter can be setup with registered MAC Address in order to connect the MATRIX host Web UI, MAC Address required by the Web page to fill in, this function can only be setup at “DISABLE”, “ENABLE”, then to press the ENTER, the second row will flash, then press the UP or DOWN to select DISABLE, ENABLE, then press ENTER to complete the setting.

## 4.8 EDID : (Default: LPCM-2CH)

Because the player output display resolution will be based on TV EDID , this Matrix provides two default EDID mode: “ BUILD-IN MODE” and “COPY MODE”.

BUILD-IN MODE COPY MODE
----------------------------

### 4.8.1 BUILD-IN MODE :

This mode supports video resolution 480p, 720p, 1080i / p at 24/50/60Hz, support LPCM two-channel audio and 5.1 channel . After enter BUILD-IN MODE menu, press UP or DOWN key to select LPCM-2CH or LPCM-5.1CH, then press ENTER to confirm setting.

LPCM-2CH LPCM-5.1CH
------------------------

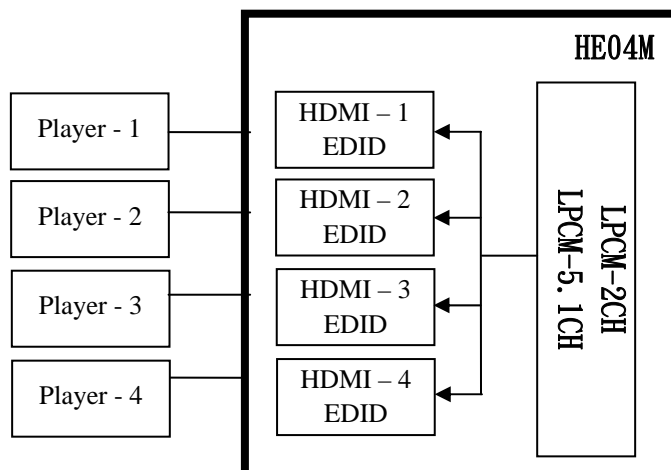

#### 4.8.2 COPY MODE :

To fully support the TV resolution and audio mode, the matrix provides “copy mode” to copy TV EDID for input source reference. When use the copy mode, recommend to copy the lowest resolution TV EDID. Otherwise it may cause no picture display if the TV resolution is not able to support higher resolution.

After entering COPY MODE menu, press UP or DOWN button to select the OUTPUT (1 to 4). Then press ENTER. Press UP or DOWN button to select the INPUT (1 to 4). Then press ENTER to confirm.

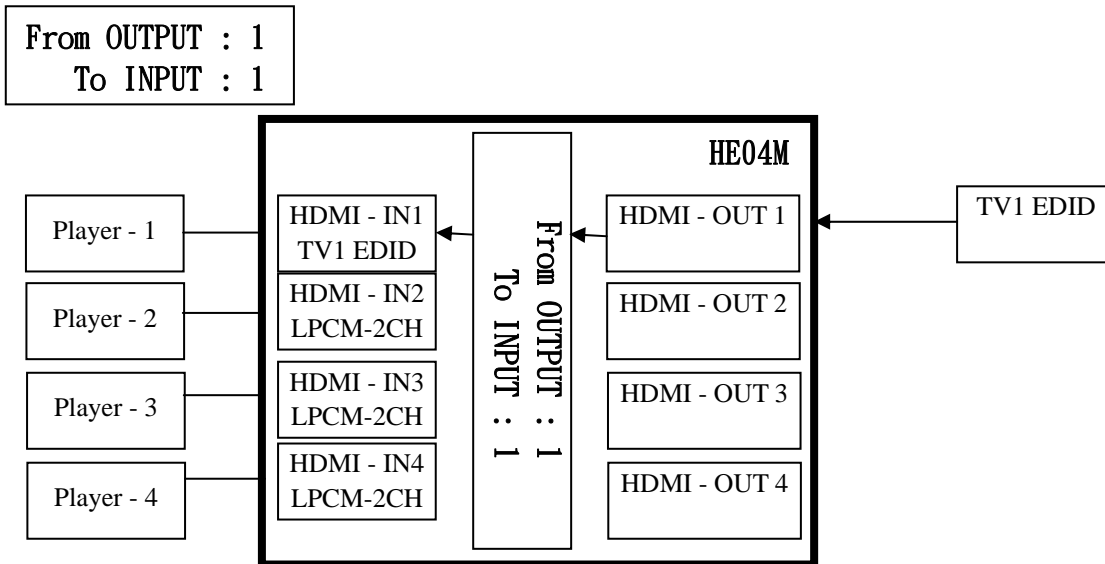

#### 4.9 FIRMWARE VER. :

Display HE04M Matrix firmware version

#### 4.10 KEYLOCK :

KEYLOCK function is to avoid any wrong button press. Under keylock mode press “POWER + MENU” to unlock

## 5.0 Remote Control Function ( IR01):

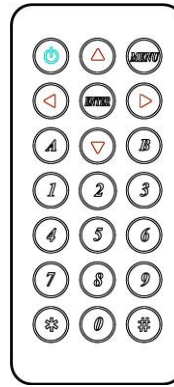

5.1 To command the matrix locally, setup the remote control IR01 ID with the same code of the Matrix (see 4.6). The default code is 4. (Power+4)

5.2 To command from remote HDBaseT output which input port must be routed on the output, setup the remote control IR01 according to chapter 4.5



- Power+0      enable to work on Output 1
- Power+1      enable to work on Output 2
- Power+2      enable to work on Output 3
- Power+3      enable to work on Output 4

5.3 Warning: These settings have to be done the first time you use the IR01 or when you change the batteries.

- IR ID setup : press and hold POWER button , then press Number key

### Remote control button define :

Symbol	Local Side	Remote Side
	Power	ON/Standby(same as Matrix)
	LEFT	left (same as Matrix)
	RIGHT	right (same as Matrix)
	UP	up (same as Matrix)
	DOWN	down (same as Matrix)
	ENTER	confirm (same as Matrix)
	MENU	menu (same as Matrix)
	Quick key1	select input 1
	Quick key2	select input 2
	Quick key3	select input3
	Quick key4	select input4
	no function	no function
	no function	no function
	no function	no function

	no function	no function
	no function	no function
	turn off output	turn off output

Local side (HE04M Matrix) Remote control Quick key operation:

For example: to connect output port 1 to input port 4, press the quick key 1 (OUTPUT 1) and then press the quick key 4 (INPUT 4).

Remote side (HDBaseT) remote control quick key operation:  
Press 1 to 4 to select the source input, press 0 to turn off the output.

\* Under using quick key operation, LCM screen will jump to the output / input setting page, it won't allow to use the front panel button to operate the HE04M Matrix.

## 6.0 RS232 Computer Local Control Function : (CONSOLE)

CONSOLE

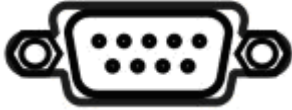

6.1 Connect the RS232 CONSOLE port to the COM port of the host by a F/M RS232 straight cable (pin 2 to pin 2; pin 3 to pin 3, pin 5 to pin 5).

The Matrix communication format is 9600,8, N, 1 (9600 bps, 8 data bits, no parity check, 1 stop bit)

### 6.2 Operation Instruction format:

Command + Space + parameter + Enter

The Matrix will reply **OK** once string is correct, **NG** in case of incorrect string

TX[x] SP [y] is the string to switch on output x the input y  
PWR SP [z] is the string to put the matrix in Standby and On status

[SYMBOL]	[PARAMETER]	
x	1   2   3   4	Output 1 to 4
y	01   02   03   04   00	Input 1 to 4, 00: Off
z	00   01	00: Standby, 01: On

Example:

-To route input 4 to output 1, send the following string:

Command            Input  
TX1            SP    04            Enter

-To route input 2 to output 3, send the following string:

Command            Input  
TX3            SP    02            Enter

-To put in standby the matrix, send the following string:

Command  
PWR            SP    00            Enter

Command are **case insensitive**. Be sure that your terminal after Enter (0D Hex) character doesn't send LF (0A). In this case, command will not be executed.

## 7.0 RS-232 Extender function : (Default: FIX MODE)



\*Cable connection please refer to the connection view page.

\* Transmission baud rate up to 115200 bps.

## 8.0 Remote side IR Extender Function:

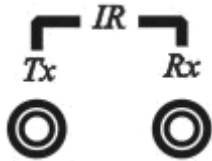

### ◆ Tx Function:

Receiving IR signal via the 4 sets HDBaseT ports, it sends out the IR signal by Tx jack (connect with 3.5 mm IR Emitter) to control source device.

### ◆ Rx Function :

Feeding IR signal to Rx jack (connect 3.5 mm IR Receiver cable) it controls remote destinations at the 4 sets HDBaseT ports at the same time.

## HDBaseT IR Function:

1. Use IR01 (remote control) to control the Matrix input port switching from receiver side. (Work with IR-CR01 IR receiver cable). See chap. 4.5
- 2 . Using remote control of source device or TV, to control source device or TV. (Work with IR-CT01 IR emitter cable, IR-CR01 IR receiver cable).

## HDBaseT linking cable:

Recommend to use high quality Cat.5e 、 Cat.6 、 Cat.6a UTP / STP or FTP cable. AWG24 or AWG23 solid type is recommended.

## HDBaseT transmission distance:

Transmission distances up to 100 meters with AWG24 cable. Using a lower resolution won't extend to longer distance.

If the CAT5e/6 cable connections go through wall socket from the wall outlet to HE02R receiver, the cable length must less 5 meters between HE02R receiver and wall socket. The wiring diagram as below:

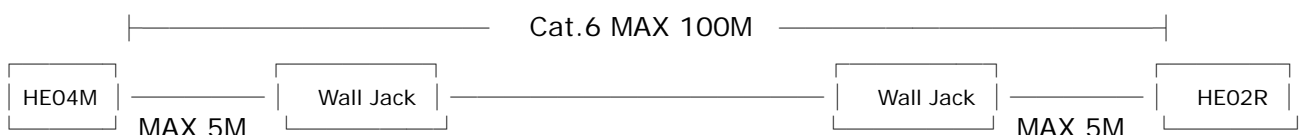

## 9.0 HDBaseT RJ45 Pin Define:

Video Link ( TIA/EIA-568-B )

1. Orange-white	DATA0 +
2. Orange	DATA0 -
3. Green-white	DATA1 +
4. Blue	DATA2 +
5. Blue-white	DATA2 -
6. Green	DATA1 -
7. Brown-white	DATA3 +
8. Brown	DATA3 -

### Caution:

1. First time to use HE04M remote control or change new batteries must set up IR ID.
2. The wiring must away from any equipment with electromagnetic wave, i.e.: microwave, mobile phone, radio equipment, high voltage, Fluorescent light fixtures, power lines, etc.
3. HDBaseT not regular network device, do not connect with any networking equipments to avoid damage.
4. IP Address, Subnet Mask, Gateway, DHCP Client, Media Type, MAC Filter setting made by HE04M ETHERNET MENU.
5. HDBaseT IR operation: Do not make IR emitter and receiver cable too close, to avoid interference and caused wrong operation.
6. HDBaseT RS232 under distribution mode: it not able to send two devices simultaneously.

## 10.Ethernet Control Function:

## Initial IP Configuration

1. Setup MATRIX IP Address same as your PC with same domains.(Default 192.168.0.200)  
MATRIX IP Address method, please refer. to “ETHERNET” Chapter
2. Input IP Address on a web page, you could link to the Web UI of the MATRIX host.
3. Web UI Operation :

### SWITCH SETTING:

MATRIX

SWITCH SETTING

RS232\_TCPIP

Power	Output	Input	
Power On	Output 1	Input 1	Reload
	Output 2	Input 2	Advanced
	Output 3	Input 3	
	Output 4	Input 4	Apply

- **Power** : Control MATRIX power on and standby.
- **Output** : Display output 1~4, it can change the display name by the Aliases page.
- **Input** : Display input 1~4, this field is a drop down menu, this field is a drop-down menu, a drop-down menu include Input 1 ~ 4 and OFF, It can change the display name by the Aliases page.
- **Reload** : Get MATRIX host message.
- **Advanced** : Enter into the “Advanced” page.
- **Apply** : Complete the setting

### Advanced:

## MATRIX

### Advanced

IP address	<input type="text" value="192.168.0.200"/>
Subnet mask	<input type="text" value="255.255.255.0"/>
Gateway IP	<input type="text" value="0.0.0.0"/>
Media Type	<input type="text" value="Auto detect"/>
DHCP Client	<input type="text" value="Disable"/>
Auto Reset (No data input)	<input type="text" value="0"/> (1 ~ 255 Minute)
Device Name	<input type="text" value="RS232_TCPIP"/>

MAC address  OnLine

- **IP address** : Change **IP address**
- **Subnet mask** : Change **Subnet mask**
- **Gateway IP** : Change **Gateway IP**
- **Media Type** : Change **10 / 100 / Auto detect**
- **DHCP Client** : When setup at **Enable**, the MATRIX host will automatic get **IP Address** 、 **Subnet Mask** 、 **Gateway**, If setup at **Disable**, the **MATRIX** host **IP Address** 、 **Subnet Mask** 、 **Gateway** need to set from Advanced page.
- **Auto Reset** : The terminal connection people will be 4 users on line at same time, this function could setup the linking time to avoid long time linking and other user can not used. When over the setting link time, the terminal will automatically disconnect the link. . (0: no time setup, 1 ~ 255 Minute time range that can be setup)
- **MAC Filter** : Enter to **MAC Filter to setup page**
- **Aliases** : Enter to **Aliases** to setup page
- **Device Name** : Can change device name
- **Back** : Jump back **SWITCH SETTING** page
- **Online** : Terminal connection users display, the max. 4 users on line.

### Aliases:

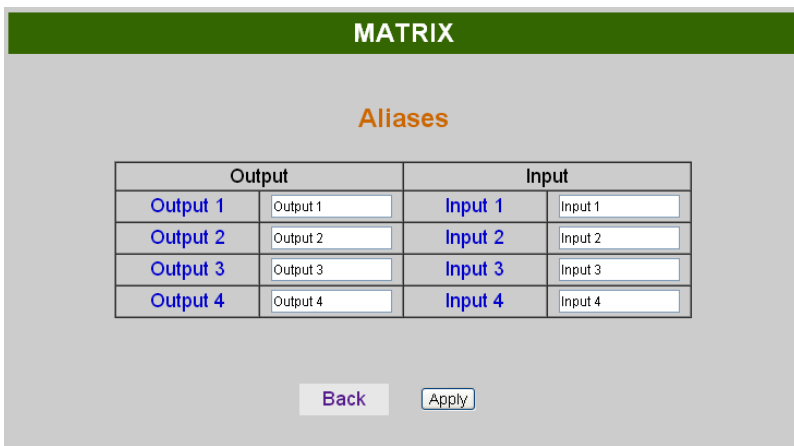

- Aliases page can change input/output name, enter **Apply** to finish the setting after change. The new name will update and correspond to SWITCH SETTING page Output / Input.
- Press Back jump back to **advanced** page.

**MAC Filter:**

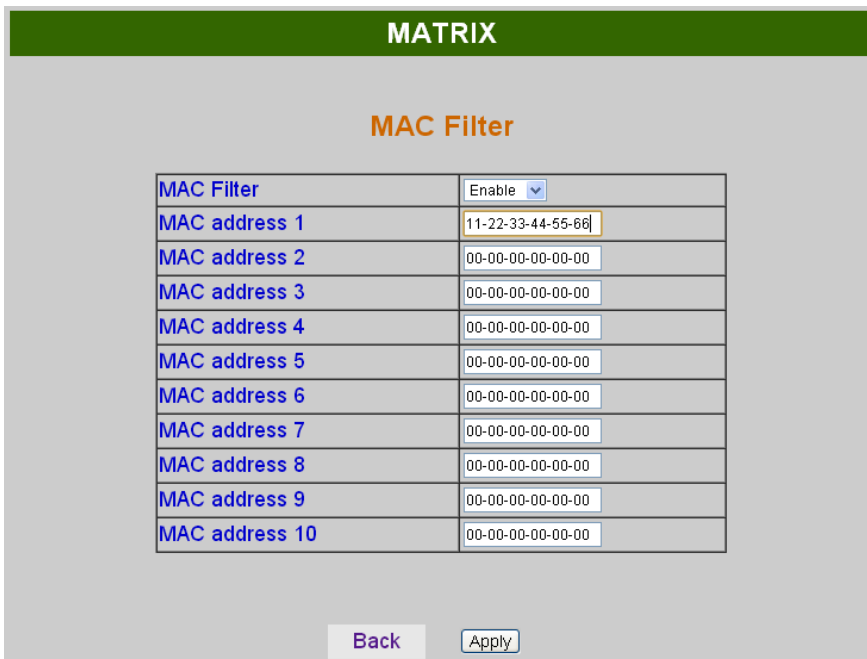

- MAC Filter can be setup as registered MAC Address to link MATRIX host Web UI, the max. up to 10 groups MAC Address
- After MAC Address fill in, select **Enable** and press **Apply** to complete the setting.
- Press **Back** jump to **advanced** page.

## Android APP Function: (Google Play : [https://play.google.com/store/apps/details?id=sct.com.matrix\\_controller02](https://play.google.com/store/apps/details?id=sct.com.matrix_controller02))

### Main Page:

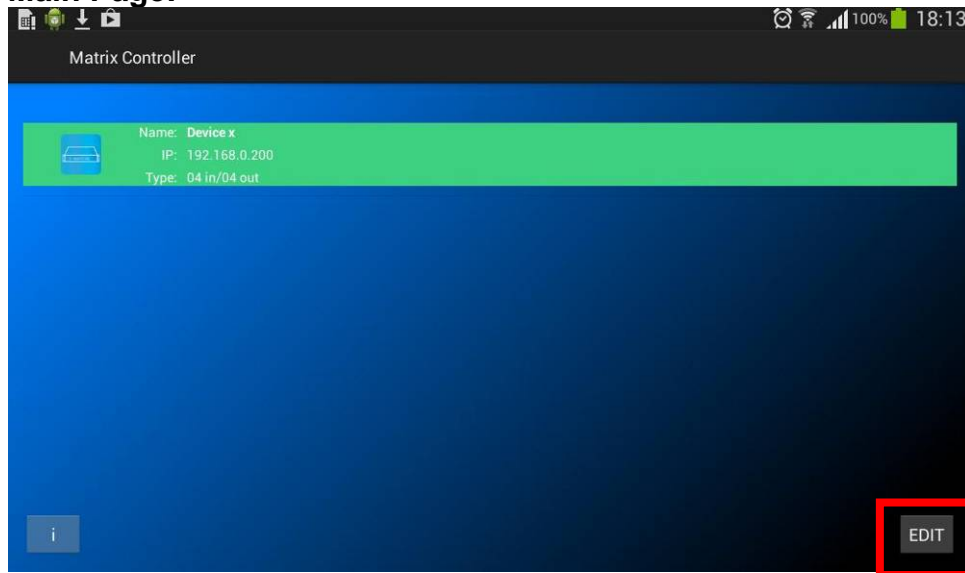

- Middle Column: **MATRIX host information**
- **I**: **Version information**
- **Edit**: **Edit button** (red box), enter to check the **Edit page description**.

## EDIT Page:

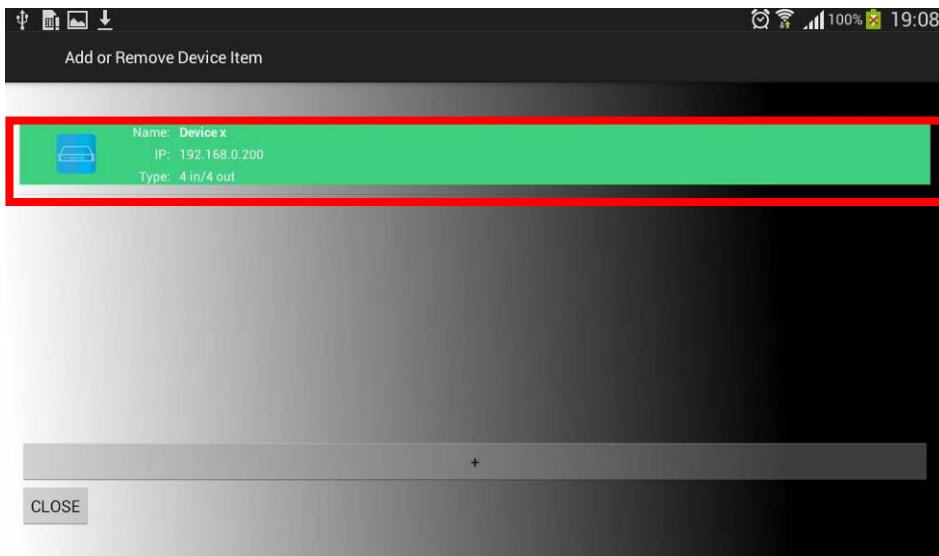

Drawing 1

- Press + to add column.
- Press middle column ( red box) to enter and modify information page, press middle column as drawing 2

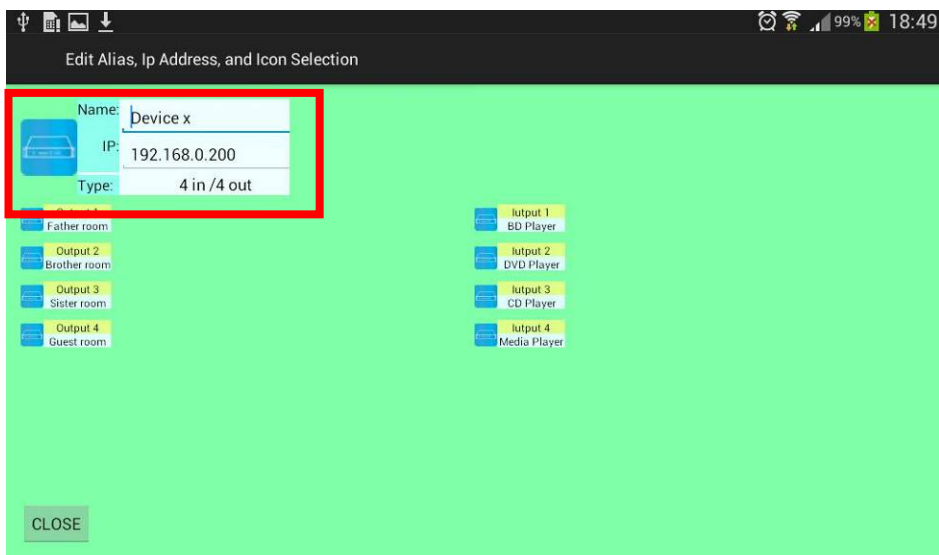

Drawing 2

- Change **Name** and **IP** , **IP** need to setup same as **MATRIX** host
- Enter **Output** and **Input** to change **Alias**, as drawing 3
- Enter drawing 3 Red box to change the icon as drawing 4
- Press **Close** to turn off the currently edit status

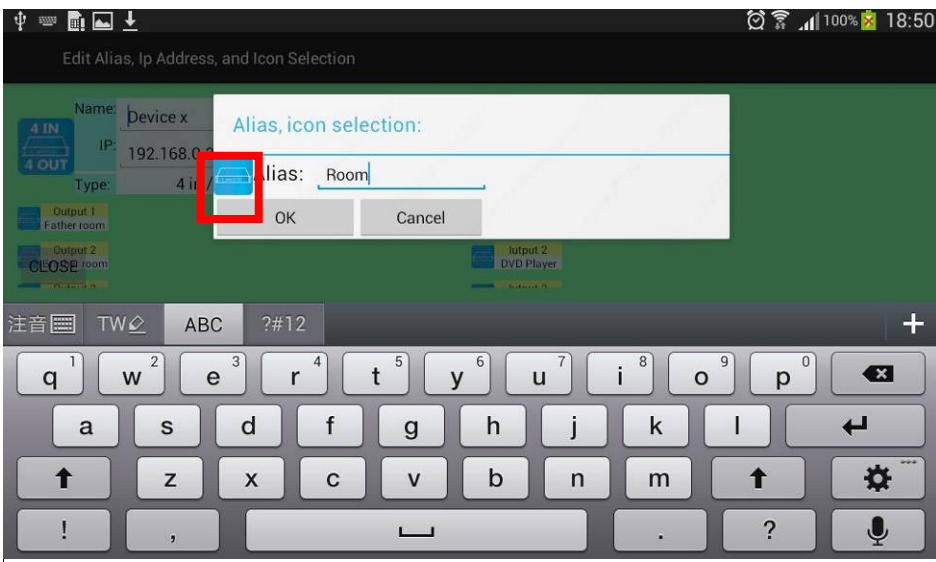

Drawing 3

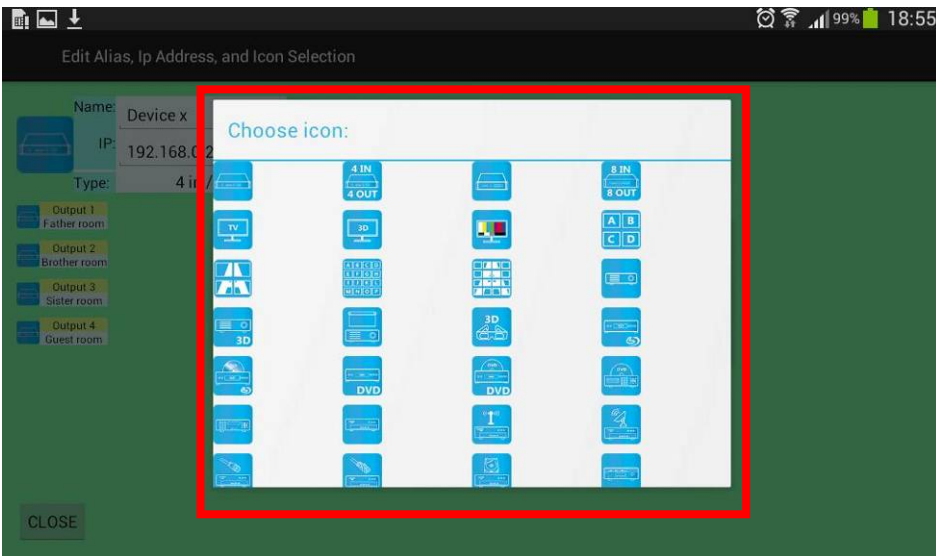

Drawing 4

## Mobile Phone Control Input port Switch Main Page:



- Middle column (Red box) is **MATRIX** information column, press middle column enter INPUT/OUTPUT control page.

## Input Port Switch page:

Drawing 1:

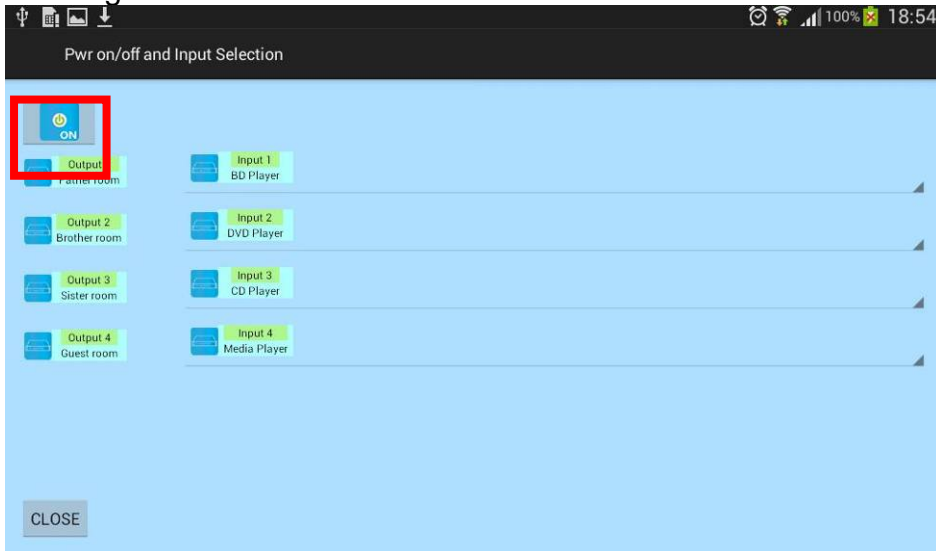

- **POWER** : Switch **MATRIX** power on/standby

Drawing 2:

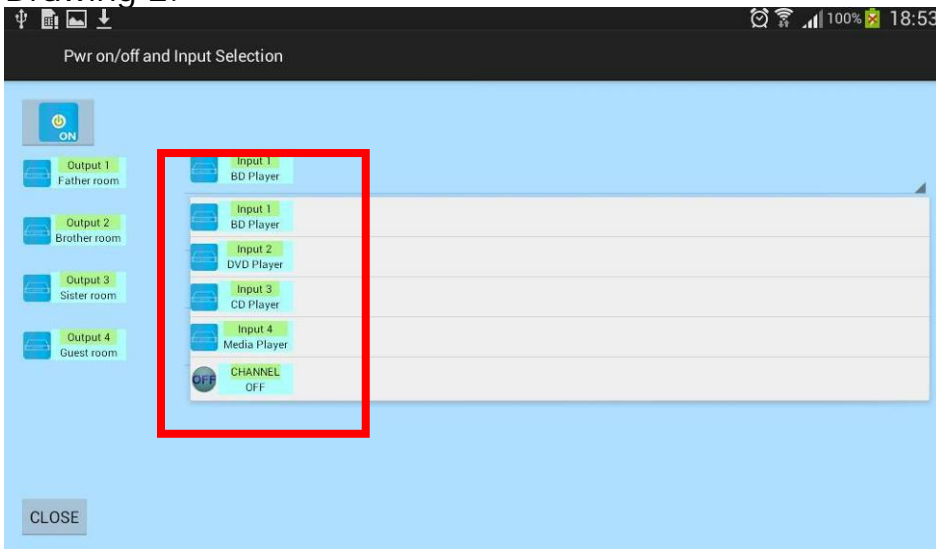

- **INPUT 1 ~ 4** are selectable icons , enter any one **ICON** will pull out 4 inputs and **Off**.
- Press **Close** back to main page

iOS APP : (iTunes: <https://itunes.apple.com/us/app/matrix-control/id904487754?l=zh&ls=1&mt=8>)

Main menu:

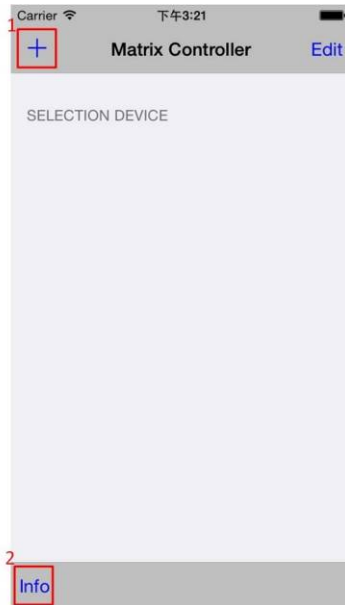

1. Click + to enter Add Device page



2. Info: version information

Add Device:

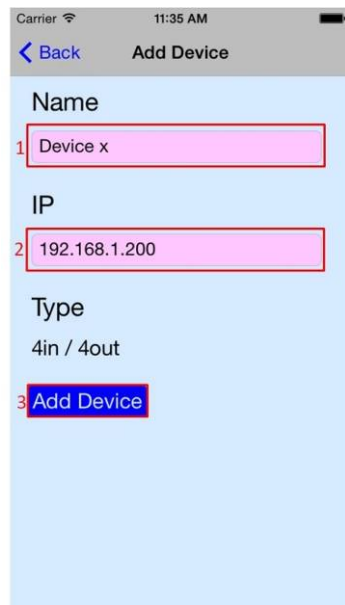

1. Set Matrix name

2. Set Matrix IP address

3. Click Add Device to save and exit



1. Click to enter input selection

2. Click the gear icon to enter Modification Device page

3. Click Edit to delete Matrix setting



1. Click - icon to show the delete icon



2. Click Delete icon to delete  
3. Click Done to save and exit

### Modification Device:

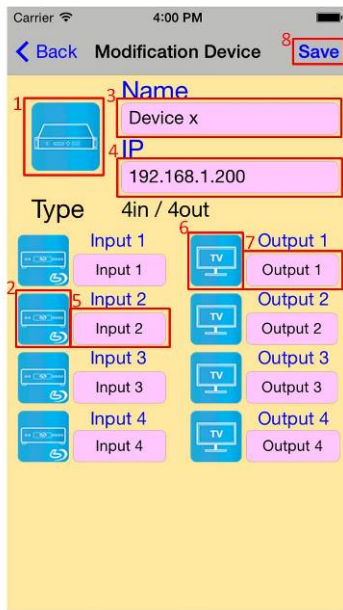

1. Click the icon to change the picture  
2. Click the icon to change the picture  
3. Set Matrix name  
4. Set Matrix IP address  
5. Change Input name  
6. Click the icon to change the picture  
7. Change output name  
8. Save and exit



## Selection device:

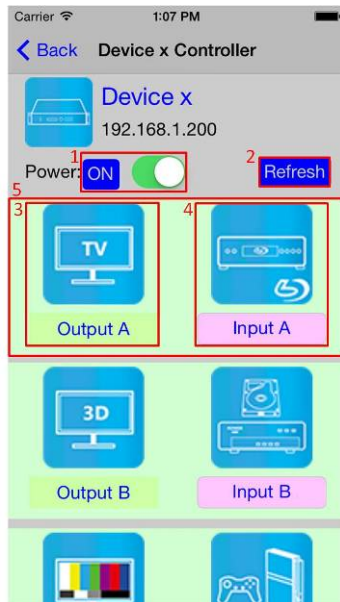

1. Power on/standby
2. Refresh Matrix connection
3. Output name
4. Input name

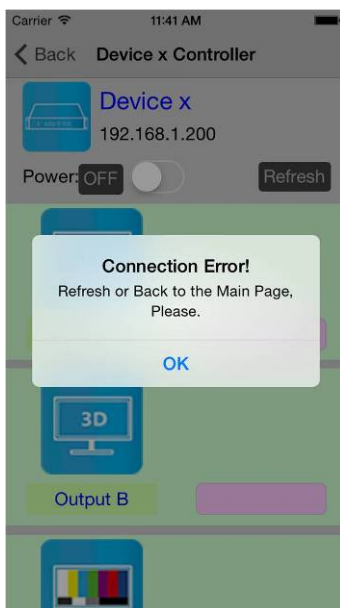

If you see the message: Connection Error!  
Please make sure the Matrix is on, IP setting is correct and in same sub net of phone/pad

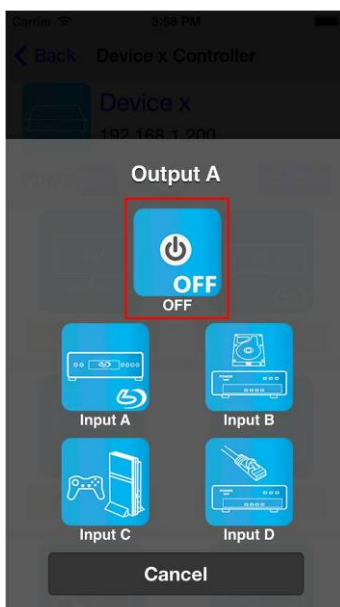

Click on the output to enter selection mode.  
You could select 4 input or off

### HE04M Standard Package Include:

- HE04M Matrix x 1 pcs
- IR01 IR Remote Control x 1 pcs
- IR Emitter Cable x 1 pcs
- IR Receiver Cable x 1 pcs
- Power Adapter x 1 pcs
- CD Software x 1 pcs

### HE04MK Package Include:

- HE04M Matrix x 1 pcs
- HE02R HDMI Receiver x 4 pcs
- IR01 IR Remote Control x 5 pcs
- IR Emitter Cable x 5 pcs
- IR Receiver Cable x 5 pcs
- Power Adapter x 5 pcs
- CD Software x 1 pcs

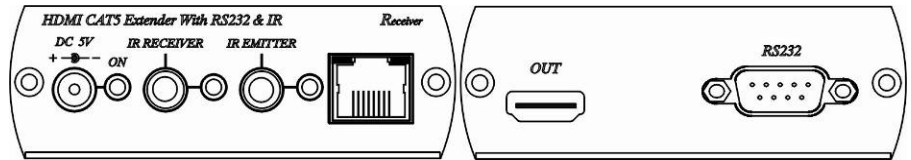

### HE04MEK Package Include:

- HE04M Matrix x 1 pcs
- HE02ER HDMI Receiver x 4 pcs
- IR01 IR Remote Control x 1 pcs
- Power Adapter x 5 pcs
- CD Software x 1 pcs

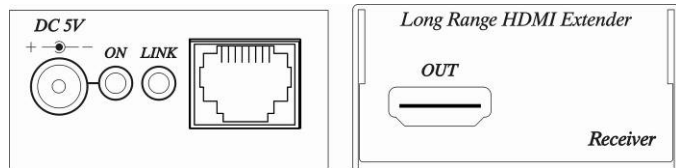

### HE04MEIK Package Include:

- HE04M Matrix x 1 pcs
- HE02EIR HDMI Receiver x 4 pcs
- IR01 IR Remote Control x 5 pcs
- IR Emitter Cable x 1 pcs
- IR Receiver Cable x 4 pcs
- Power Adapter x 5 pcs
- CD Software x 1 pcs

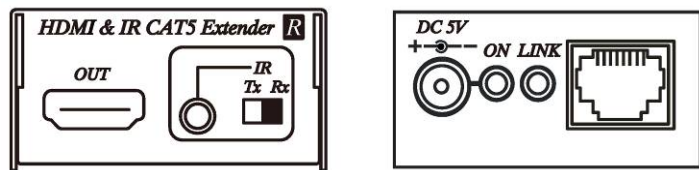

### Specification:

ITEM NO.	HE04M
HDMI Input Max. Resolution	1080p @ 60Hz 12bit, 3D
Video Input	HDMI Type A x 4
HDBaseT RJ45 output Max. Resolution	1080p at 60Hz 12bit
HDBaseT Max. Distance	100 Meters
Video Output	HDMI Type A x 4 and RJ45 x4
Ethernet Input/Output	RJ45 x 1
HDBaseT RJ45 output Max Distance	100 meters
IR Input/Output	Phone Jack x 2
HDBaseT IR Carrier Frequency	30-60Khz
HDBaseT IR Angle	Tx : ±30d degree , Rx : ±55 degree
HDBaseT IR Distance	5m
HE04M IR Receive Angle	±45 degree
HE04M IR Receive Distance	5M
RS232 Input/Output	DB9 x 5
Power Adapter	DC 12V 4.2 Amp
Power Consumption	2.6 Amp (Max)
Temperature	Operation: 0 to 55°C, Storage: -20 to 85°C, Humidity: up to 95%
Dimension	mm 483 x 197 x 44
Weight	g 2400

ITEM NO.	HE02R (HE04MK Kit receiver)	
Resolution	Up to 1080p / 60Hz / 12 bit	
Distance	100M (Max)	
HDMI Connector	Type A	
RS-232 Baud Rate	Up to 115200 bps / Full Duplex	
RS-232 Connector	DB9 Male	
IR Carrier	30-60Khz / $\pm 10^\circ$ / 5M / 2 Way	
Power Supply	DC 5V 2AMP Regulated	
Power Consumption	1200mA (Max)	
Temperature	Operation: 0 to 55°C, Storage: -20 TO 85°C, Humidity: up to 95%	
Dimension	mm	88 x 130 x 30
Weight	g	270

ITEM NO.	HE02ER (HE04MEK Kit receiver)	HE02EIR (HE04MEIK Kit receiver)
Resolution	Up to 1080p / 60Hz / 12 bit	
Distance	100 m (Max)	50 m by CAT5e/6, 70 m by CAT6a
Video Output	HDMI Type A x 1	
IR Carrier Frequency	X	30-60KHz
IR Angle	X	$\pm 55$
IR Distance	X	5m
Power Supply	Regulated DC5V 2A	
Power Consumption	1200mA (Max)	820mA (Max)
Temperature	Operation: 0 to 55°C, Storage: -20 TO 85°C, Humidity: up to 95%	
Dimensions	mm	49 x 92.3 x 25
Weight	g	135

RoHS   

Rev. B1