

HDMI Matrix Switcher Series

ITEM NO.: HE10M 10 x 10 HDMI Matrix Switcher

HE10M 10x10 HDMI Matrix Switch allows you to route 10 HD sources to any 10 HD displays! The **10x10 HDMI Matrix switch** is a complete HD routing solution for whole home HDTV systems. It provides **3D support, UltraHD 4K2K**, and with **2U Rack** mountable for professional installations. In addition, the **HE10M** allows for effortless control of up to 10 devices through Ethernet control, Android/IOS App Control, IR remote control, RS-232 and the front panel.



Features:

- Connect up to 8 HDMI and 2 HDBaseT source to 8 x HDMI and 2 HDBaseT display monitors.
- HDMI 1.4 with 3D, HDCP & DVI Compliant.
- High definition video up to 4K2K@30Hz@8bits, 1080p@60Hz@12bits
- Easy to use front panel control of switching or using the included remote control.
- Built in Ethernet Control and Android/IOS App Control.
- Built in RS232 console port to select input/output.
- Input/Output status could be displayed at front panel LCM & LED.
- **Optional CAT5E/CAT6 Receiver Model:**
 - HE02EIR: 70m HDMI and IR mono directional Receiver
 - HE02ER: 100m HDMI Receiver
 - HE02R : 100m HDMI, bidirectional IR and RS232 Receiver
 - HE02N : 100m HDMI, bidirectional IR and RS232, Ethernet Receiver

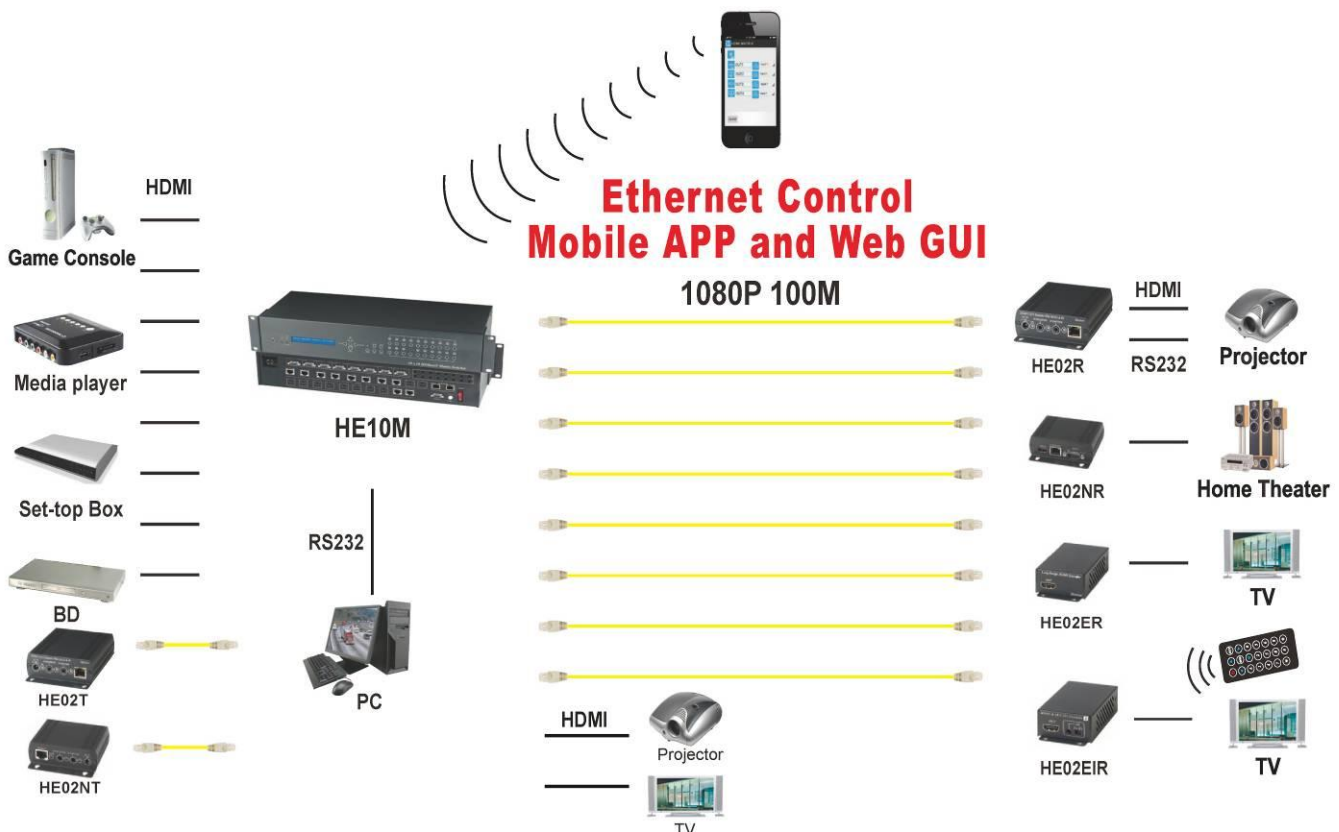

1.0 HE10M Panel View:

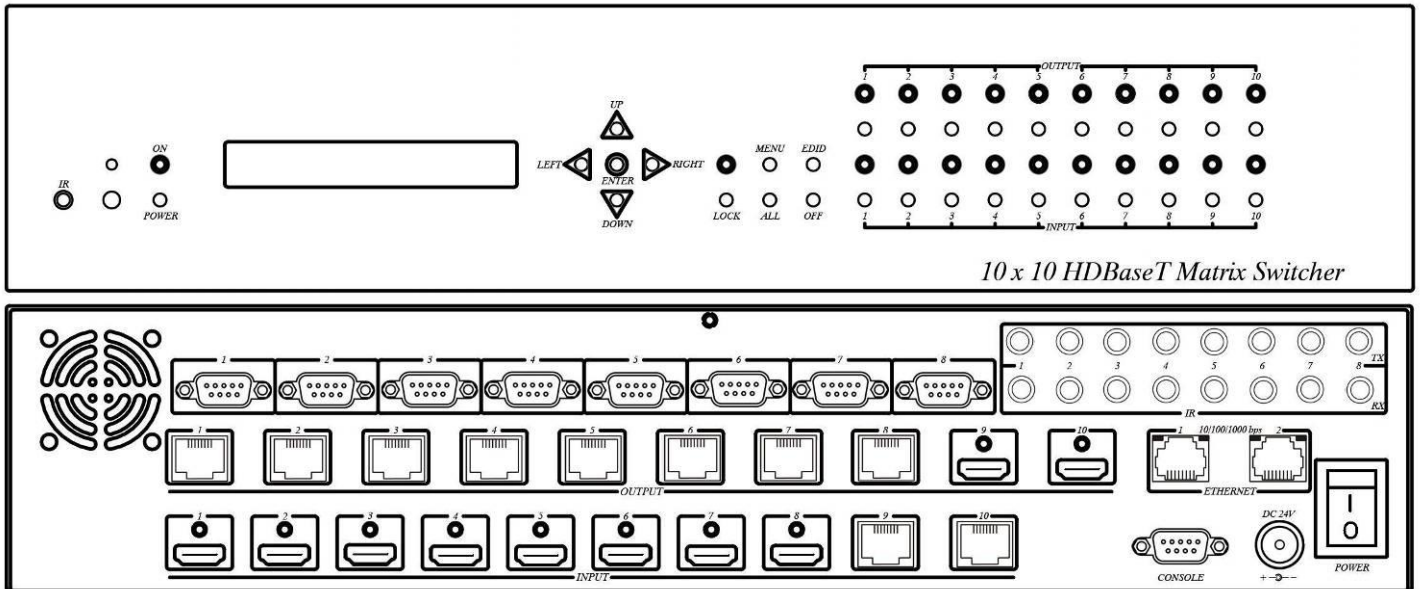

2.0 HE10M Connection View:

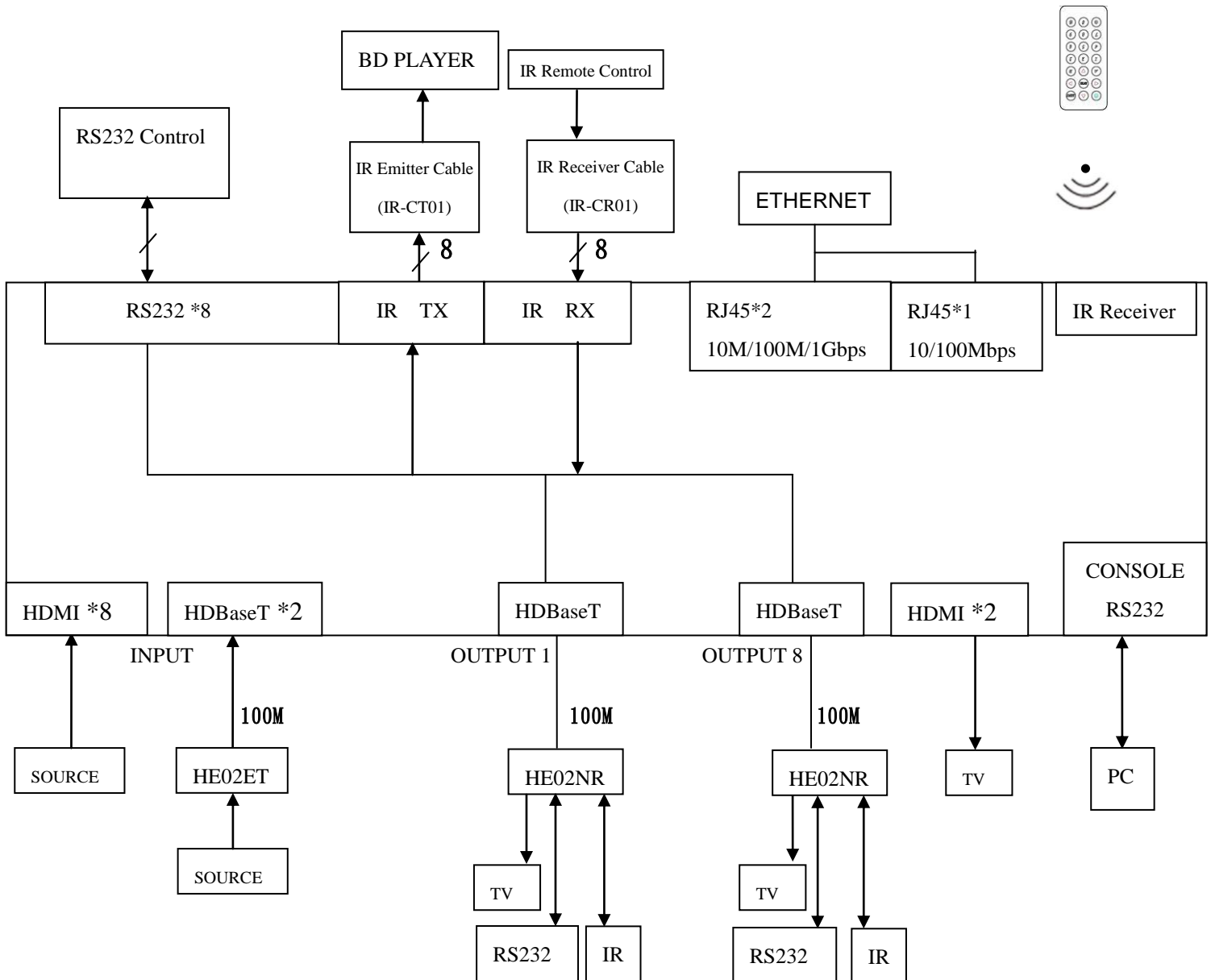

3.0 Keypad and LEDs

3.1 Back Panel Switch:

POWER	Light on	Power on
	Light off	Power off

3.2 Back LED Indication:

10M/100M bps	Yellow	Ethernet link
	Green	Ethernet data transmission

10M/100M/1G bps	Yellow	1G bps link speed
	Green	10M/100M bps link speed

3.2 Front LED Indication:

ON	BLUE	Power on
	RED	Standby
	LED off	Power Off

INPUT 1~10	BLUE	Signal indication
	LED off	No signal

OUTPUT 1~10	BLUE	HDMI output indications
	LED off	Output unlink

Standby mode: The IR Remote only could control POWER on/off.

Front Button Function:

Power	Power on/standby
UP	Up
DOWN	Down
LEFT	Left
RIGHT	Right
ENTER	Select confirm key
MENU	Back to main menu/channel setting
EDID	Copy EDID
LOCK	Button lock
ALL	Set selected input channel to all output When press ALL the second line of panel will show IN and flashing, select the input 1~10 then press ENTER
OFF	Turn off selected output, could be 1~10 or ALL When press OFF the second line of panel will show IN and flashing, select the input 1~10 or ALL then press ENTER
OUTPUT 1~10	Fast switch output
INPUT 1~10	Fast switch input

3.3 Panel button Function:

OUTPUT 1~10 & INPUT 1~10

Press OUTPUT 1~10 to select output port then the input at IN line of LCM will blink, press INPUT 1~10 to select input port to switch the channel

ALL :

Press ALL button, the IN line of LCM will blink, press INPUT 1~10 to select input port to all output port.

OFF :

Press OFF button, the IN line of LCM will blink, press ALL or OUTPUT 1~10 to select which port to turn off

EDID :

Press EDID button, it will show "From OUTPUT" at second line of LCM and the channel number will blink, press OUTPUT 1~10 to select which port to copy EDID.

LOCK :

Press LOCK till LOCK LED on then the panel button and IR remote control of MATRIX will be locked. Press LOCK till LOCK LED off to unlock.

*When the sub-menu setting changed, press the ENTER key to complete the setting. If no press ENTER key, then the setting will be failed.

3.3 LCM Panel Function:

Power on Main Screen

When the power is on and the main screen appears

10X10 HDMI MATRIX

Channel Setting on Main Screen

The Matrix will jump to channel setting screen after 10 seconds, press the MENU key to enter the main

OUT	1	2	3	4	5	6	7	8	9	10
IN	1	2	3	4	5	6	7	8	9	10

Main MENU Option:

- *1 - SWITCH**
- 2 - SCENE**
- 3 - ETHERNET**
- 4 - EDID**
- 5 - REMOTE ID**
- 6 - VERSION**
- 7 - RS-232 SETTING**
- 8 - IR MODE SETTING**
- 9 - IR TX SETTING**
- 10 - IR RX SETTING**
- 11 - HDBaseT IR ID**

Operation:

- Press UP or DOWN key to move * to select an item for setting and press ENTER key to enter into subpage.
- In MENU you could use key 1~11 of IR remote control to select the functions.
- When the selected sub-page setting is completed, press the MENU button to return to the main page

4.0 LCM Main MENU Function Operations:

4.1 SWITCH : (Default: 1 2 3 4 5 6 7 8 9 10)

This function is used to switch the input/output port. Enter the SWITCH menu. Press the ENTER key, then the LCM second line INPUT will flash. Press LEFT or RIGHT button to select the output to be modified. Then press Up or Down button to select the input port. After that, press ENTER to confirm setting.

It also works with INPUT/OUTPUT button of panel or IR remote

OUT	1	2	3	4	5	6	7	8	9	10
IN	1	2	3	4	5	6	7	8	9	10

4.2 SCENE:

SCENE function provide 10 sets of channel setting to fast reload for different application.

LOAD
SAVE

LOAD

Reload saved scene, press UP or DOWN to select the number of setting ENTER to load.

LOAD 1
1 2 3 4 5 6 7 8 9 10

SAVE

Save current channel setting, press UP or DOWN to select the number and ENTER to save.

SAVE 1

4.3 Ethernet

- * IP Address
- Subnet Mask
- Gateway
- DHCP Client
- Media Type
- MAC Filter

IP Address: (Default: 192.168.0.10)

IP Address 192.168. 0.10

This function can be setup MATRIX host intranet "IP Address", press the ENTER, the left-most number of second row will flash, then press the UP or DOWN button to change the numbers, , press LEFT or RIGHT to move to another location, the move to a position number will flash, press ENTER to complete the setting.

Subnet Mask: (Default 255.255.255.0)

Subnet Mask 255.255.255.0
--

This function can be setup MATRIX host intranet "Subnet Mask", press the ENTER, the left-most number of second row will flash, then press the UP or DOWN button to change the numbers Press the ENTER, , press LEFT or RIGHT to move to another location, the move to a position number will flash, press ENTER to complete the setting.

Gateway: (Default 192.168.0.1)

Gateway 192.168. 0. 1
--

This function can be setup MATRIX host intranet "Gateway", press the ENTER, the left-most number of second row will flash, then press the UP or DOWN button to change the numbers Press the ENTER, , press LEFT or RIGHT to move to another location, the move to a position number will flash, press ENTER to complete the setting.

DHCP Client: (Default Disable)

**DHCP Client
Disable**

When DHCP Clients setup at “Enable”, the MATRIX host will automatically get IP Address, Subnet Mask, Gateway, if setup at “Disable”, the MATRIX Host IP Address need go through “ ETHERNET” menu to set IP Address, Subnet Mask, Gateway, to press the ENTER, the second row will flash, then press the UP or DOWN to select DISABLE, ENABLE, then press ENTER to complete the setting.

Media Type: (Default AUTO)

**Media Type
AUTO**

This function can be setup MATRIX host intranet “Media Type, press the ENTER, the second row will flash, then press the UP or DOWN button to select AUTO 、 10MHalf 、 10MFull 、 100MHalf 、 100MFull, press ENTER to complete the setting.

MAC Filter : (Default Disable)

**MAC FILTER
DISABLE**

MAC Filter can be setup with registered MAC Address in order to connect the MATRIX host Web UI, MAC Address required by the Web page to fill in, this function can only be setup at “DISABLE”, “ENABLE”, then to press the ENTER, the second row will flash, then press the UP or DOWN to select DISABLE, ENABLE, then press ENTER to complete the setting.

4.4 EDID: (Default: 1080P LPCM-2CH)

Because the player output display resolution will be based on TV EDID, this Matrix provides two default EDID modes: "BUILD-IN MODE" and "COPY MODE".

BUILD-IN MODE
COPY MODE

4.4.1 BUILD-IN MODE :

This mode supports video resolution 480p, 720p, 1080i / p at 24/50/60Hz, support 1080P LPCM two-channel audio and 5.1 channel. After enter BUILD-IN MODE menu, press UP or DOWN key to select 1080P LPCM-2CH or 1080P LPCM-5.1CH, then press ENTER to confirm setting.

1080P LPCM-2CH
1080P LPCM-5.1CH

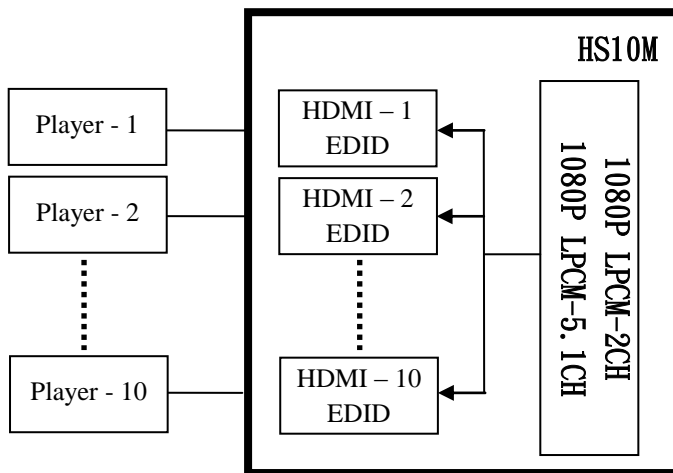

COPY MODE :

To fully support the TV resolution and audio mode, the matrix provides "COPY MODE" to copy TV EDID for input source reference. When use the copy mode, recommend copying the lowest resolution TV EDID. Otherwise it may cause no picture display if the TV resolution is not able to support higher resolution.

After entering COPY MODE menu, press UP or DOWN button to select the OUTPUT (1 to 10). Then press ENTER to confirm.

COPY MODE
From OUTPUT: 1

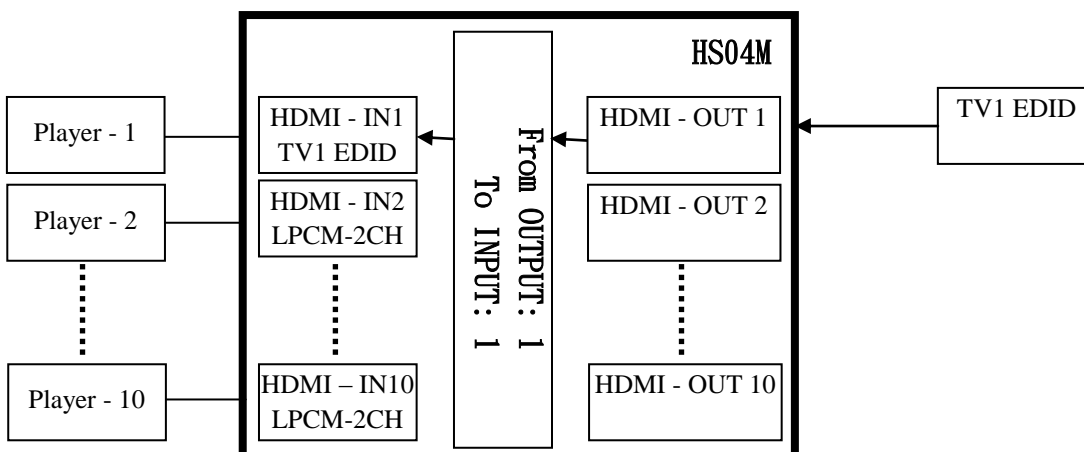

4.5 REMOTE ID : (Default IR ID: 4)

This function must be set to match the Matrix remote control IR01 with the matrix itself. A conflict with other devices remote control is avoided.

After entering MATRIX IR ID menu, press ENTER, the LCM LINE 1 number will flash. Then Press UP or DOWN button to select the number, and then press ENTER to confirm.

When finish MATRIX IR ID setting, MATRIX remote control IR01 must also set the same ID in order to operation in normal.

Remote IR ID setting mode: Press and hold the POWER button, then press the number button which can be set from 0 to 9, total 10 groups. (See 5.1)

These settings on IR01 remote control have to be done the first time you use the IR01 or when you change the batteries.

MATRIX IR ID 4



4.6 VERSION:

Display Matrix and WEB firmware version

MATRIX VERSION 1.00
WEB VERSION 1.00

4.7 RS-232 SETTING : (Default: FIX MODE)

HDBaseT RS-232 extender function works in two mode. Enter RS-232 SETTING MENU, press ENTER. The * will flash, then press UP or DOWN button to select FIX MODE or MATRIX MODE. Press ENTER key to confirm setting.

- FIX MODE is one to one transmission, RS-232 port 1 only work with HDBaseT port 1, RS-232 port 2 only work with HDBaseT port 2, and so on...

*** FIX MODE**
MATRIX MODE

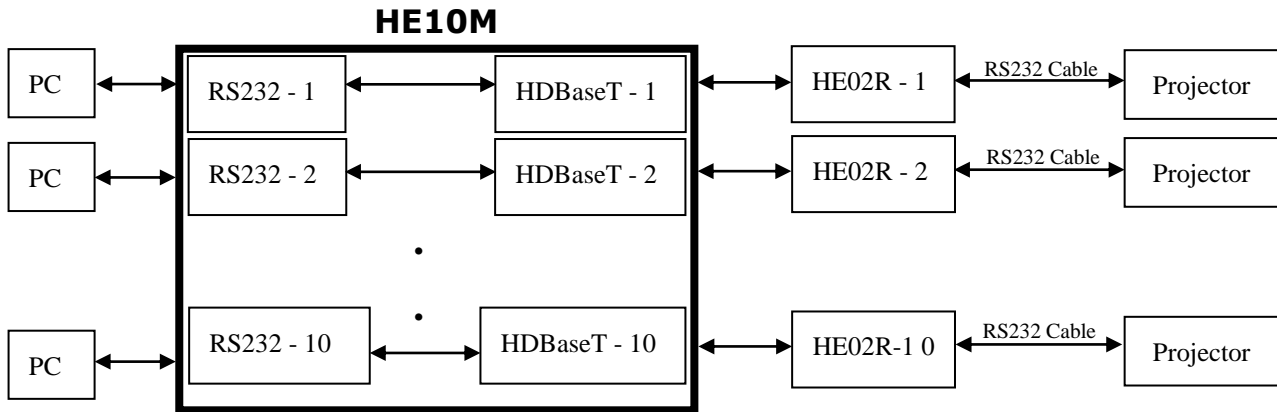

RS-232 SETTING : FIX MODE

- RS-232 MATRIX MODE is based on the Status of the Matrix. The RS-232 transmission will follow the HDMI switching. In the example below, RS-232 port 1 work with HDBaseT port 1, 2 and 3. RS-232 port 10 works with HDBaseT port 10

FIX MODE
*** MATRIX MODE**

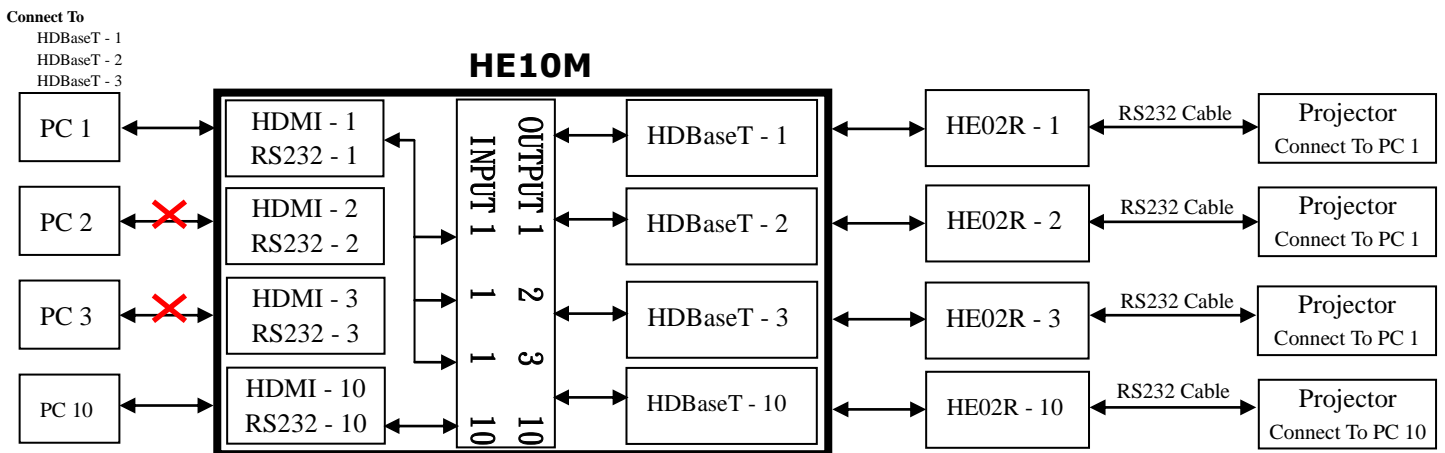

RS-232 SETTING : MATRIX MODE

4.8 IR MODE SETTING : (Default: FIX MODE)

HDBaseT IR extender function works in two mode. Enter IR MODE SETTING MENU, press ENTER. The * will flash, then press UP or DOWN button to select FIX MODE or MATRIX MODE. Press ENTER key to confirm setting.

- FIX MODE is one to one transmission, IR port 1 only work with HDBaseT port 1, IR port 2 only work with HDBaseT port 2, and so on...

* **FIX MODE**
MATRIX MODE

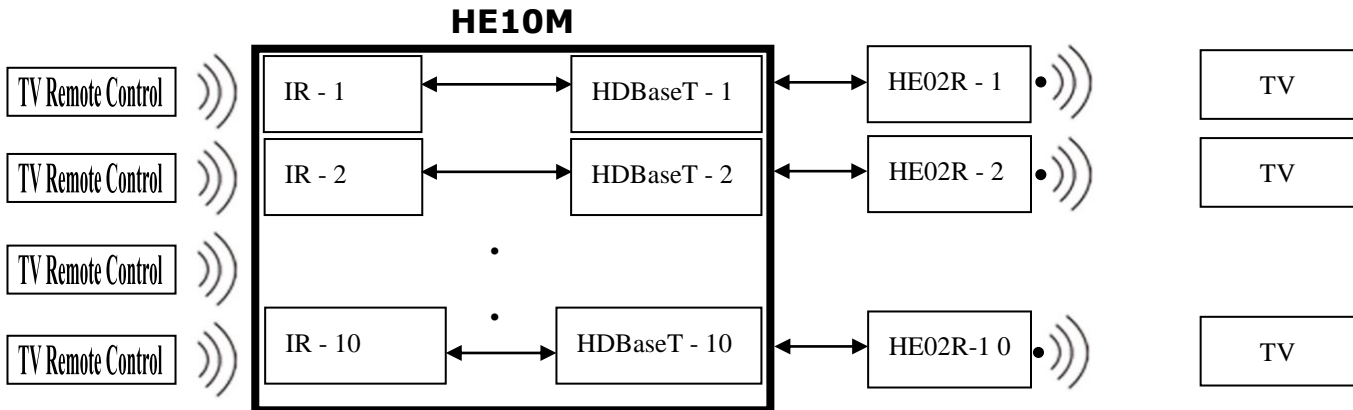

IR MODE SETTING : FIX MODE

- IR MATRIX MODE is based on the Status of the Matrix. The IR transmission will follow the HDMI switching. In the example below, IR port 1 work with HDBaseT port 1, 2 and 3. IR port 10 works with HDBaseT port 10

FIX MODE
 * **MATRIX MODE**

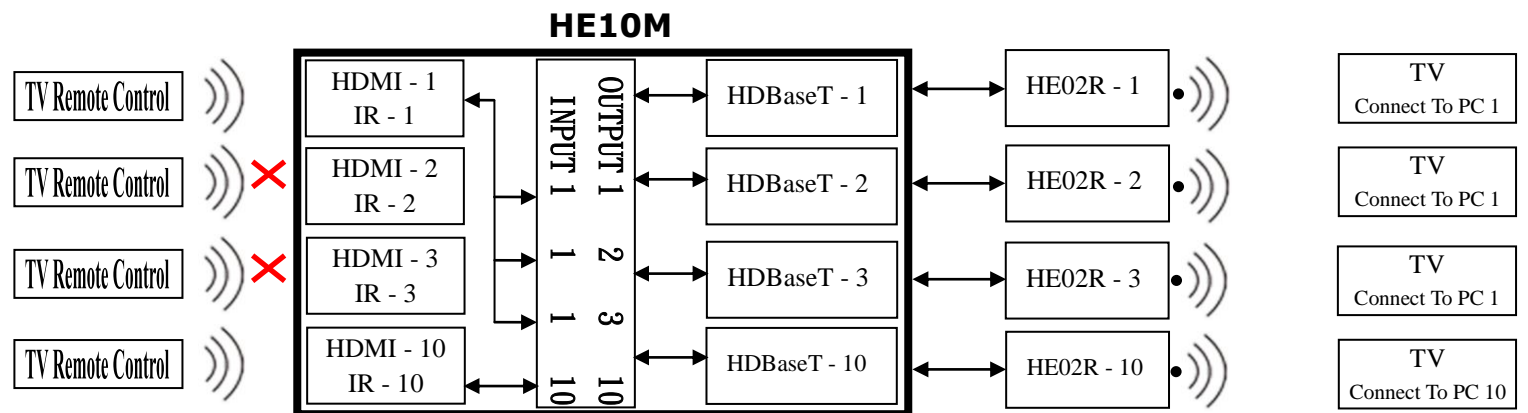

IR MODE SETTING : MATRIX MODE

4.9 IR TX SETTING (From matrix to remote locations):

(Default IR TX: 0 0 0 0 0 0 0 0)

This function setup the IR signal whether from MATRIX, by IR Rx input jack, is sent to HDBaseT ports. Setting 0 the transmission is enabled, setting X transmission is off.

This is the typical application when the user wants to control from the matrix side the remote destination like a TV.

After entering IR TX SETTING menu, press ENTER. Then LCM second line of text will flash. Press RIGHT or LEFT button to select the IR TX output to be modified Press Press UP or DOWN button to select 0 or X. Then press ENTER to confirm setting.

HDBaseT	1	2	3	4	5	6	7	8
IR TX	0	X	0	0	0	0	0	0

0 : on **X : off**

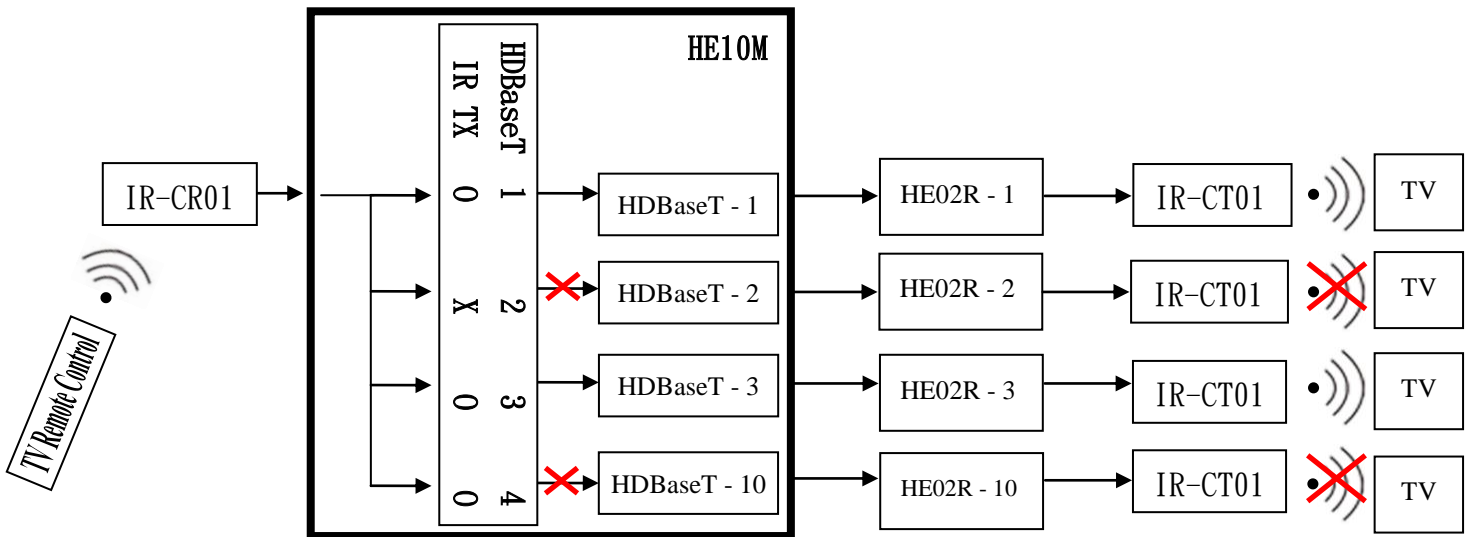

4.10 IR RX SETTING(From remote locations to matrix) :

(Default IR RX: 0 0 0 0 0 0 0 0)

This function setup the IR signal whether from HDBaseT location is sent to MATRIX to control local device through the IR Tx output jack. Setting O the transmission is enabled, setting X transmission is off.

This is a typical application when the user wants to control from the remote location a source like a DVD player.

After entering IR RX SETTING menu, press ENTER. Then LCM second line of text will flash. Press RIGHT or LEFT button to select the IR RX input to be modified. Press UP or DOWN button to select O or X. Then press ENTER to confirm setting.

HDBaseT	1	2	3	4	5	6	7	8
IR RX	0	X	0	0	0	0	0	0

O : on X : off

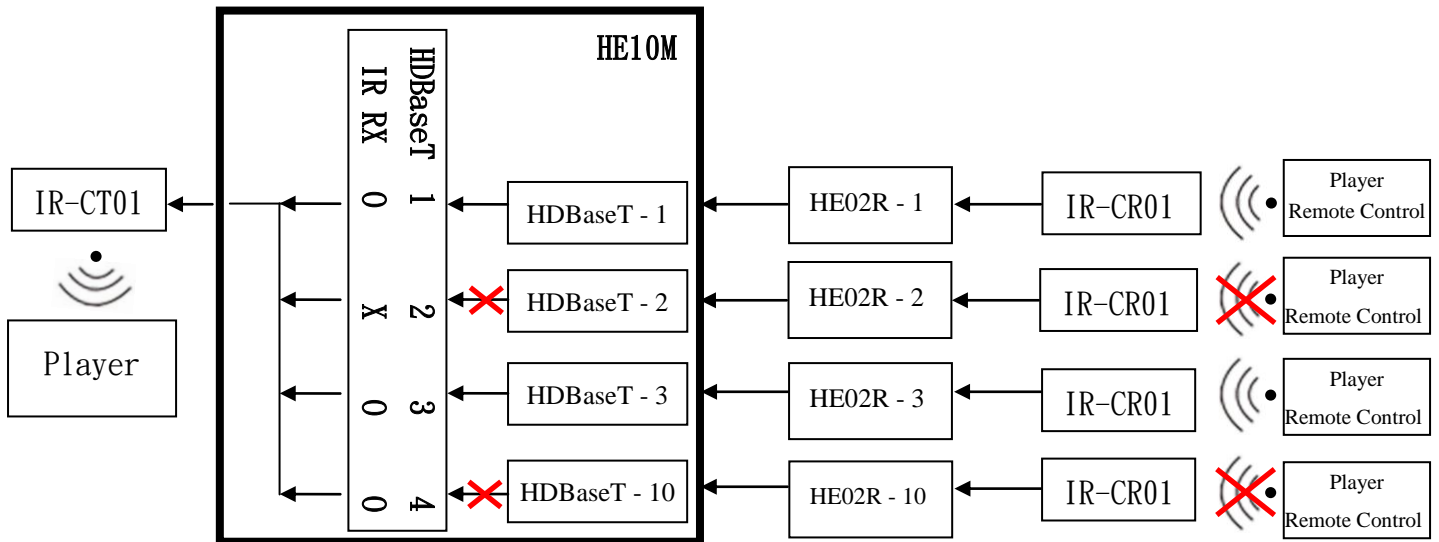

4.11 HDBaseT IR ID : (Default IR ID: 5 5 5 5 5 5 5 5)

HDBaseT	1	2	3	4	5	6	7	8
IR ID	5	5	5	5	5	5	5	5

This function must be set to have different ID in order to avoid HDBaseT remote control IR01 conflicts with other devices remote control.

After entering HDBaseT IR ID menu, press ENTER. Then LCM second line of text will flash. Press RIGHT or LEFT button to select the IR ID input to be modified. Press UP or DOWN button to select the ID. Then press ENTER to confirm setting.

When you finish the HDBaseT IR ID setting, the HDBaseT remote controls IR01 must also be set with the **same ID** in order to perform the right operations. (See 5.2)

Remote IR ID setting mode: Press and hold the POWER button, then press the number button which can be set from 0 to 9, total 10 groups. (See 5.2)

These settings on IR01 remote control have to be done the first time you use the IR01 or when you change the batteries.

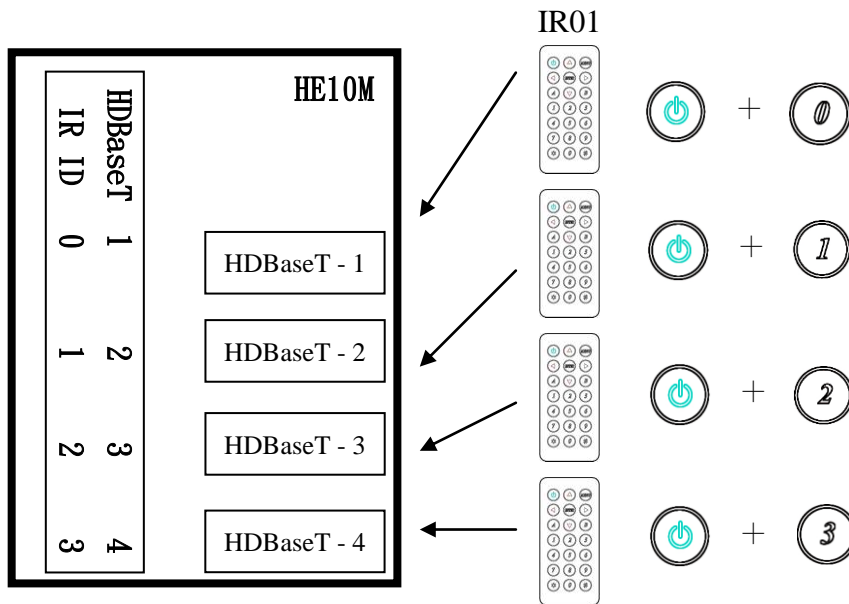

5.0 Remote Control Function (IR01):













5.1 To command the matrix locally, setup the remote control IR01 ID with the same code of the Matrix (see 4.2). The default code is 4. (Power+4)

5.2 Warning: These settings have to be done the first time you use the IR01 or when you change the batteries.

- IR ID setup : press and hold POWER button , then press Number key

Remote control button define:

Symbol	Local Side	Remote Side
 Power	ON/Standby (same as Matrix)	off output
 LEFT	left (same as Matrix)	no function
 RIGHT	right (same as Matrix)	no function
 UP	up (same as Matrix)	no function
 DOWN	down (same as Matrix)	no function
 ENTER	confirm (same as Matrix)	no function
 MENU	menu (same as Matrix)	no function
 1	Quick key 1	select input 1
 2	Quick key 2	select input 2
 3	Quick key 3	select input 3

	Quick key 4	select input 4
	Quick key 5	select input 5
	Quick key 6	select input 6
	Quick key 7	select input 7
	Quick key 8	select input 8
	Quick key 9	select input 9
	Quick key10	select input 10
	EDID (same as Matrix)	no function
	OFF (same as Matrix)	no function

Local side (HE10M Matrix) remote control quick key operation:

For example: to connect output port 1 to input port 4, press the quick key 1 (OUTPUT 1) and then press the quick key 4 (INPUT 4).

***IR remote can only power on the matrix at standby mode.**

Remote side (HDBaseT) remote control quick key operation:

Press 1 to 4 to select the source input, press 0 to turn off the output.

6.0 REMOTE Control Function :

HE10M support RS232 and TCP/IP control by same command as below:

6.1

For RS232 CONSOLE:

Connect the RS232 CONSOLE port to the COM port of the host by an F/M RS232 straight cable (pin 2 to pin 2; pin 3 to pin 3, pin 5 to pin 5)

Communication format is 9600, 8, N, 1 (9600 bps, 8 data bits, no parity check, 1 stop bit)

CONSOLE



For Ethernet TCP/IP(Winsock)

Default IP address: 192.168.0.10, Port:47011

ETHERNET



6.2 Operation Instruction format:

Command + Δ (Space) + Parameter + Enter

[Command]

[Description]

POWER Δ [y]

Power on/off

TX[n] Δ [n]

Set RXn to TXn

RX[n] Δ [m,m,m,m...]

Set RXn to multiple TXm,m,m,m...

RS232 Δ [a]

Set RS232 fix or matrix mode

IRMODE Δ [A]

Set IR fix or matrix mode

IR_TX Δ [b]

Set TX IR on/off

IR_RX Δ [b]

Set RX IR on/off

HDBASET_ID Δ [p,p,p,p]

Set HDBaseT IR ID

MATRIX_ID Δ [p]

Set Matrix IR ID

EDID_COPY Δ [n]

Copy EDID from TX n

SAVE Δ [n]

Save setting to #n

LOAD Δ [n]

Load setting from #n

KEY Δ [y]

Panel button& IR remote control Lock/Unlock

DHCP△[y]	DHCP client on/off
IP_ADDRESS△[x.x.x.x]	Set Matrix IP address
SUBNET_MASK△[x.x.x.x]	Set Matrix subnet mask
GATEWAY△[x.x.x.x]	Set Matrix gateway
MEDIA_TYPE△[z]	Network speed select
MAC_FILTER△[y]	Mac filter on/off
STATUS	Show connection status
VERSION	Show firmware version
HELP	Help

[Symbol]

[Parameter]

m	01~10, ff=ALL
n	00=off, 01~10=1~10
a	FIX MATRIX
b	0 or X 0 or X 0 or X 0 or X 0 or X 0 or X 0 or X 0 or X (0 = on X = off)
p	00~09=0~9
x	0~255
y	00=off, 01=on
z	00=auto, 01=10M, 02=100M, 03=10M Full, 04=10M Half

Example:

-To route input 4 to output 1, send the following string:

TX01△04Enter

-To route input 2 to all output, send the following string:

RX02△ffEnter

-To route input 2 to output 1,2,4, send the following string:

RX02△01,02,04Enter

-To put in standby the matrix, send the following string:

POWER△00Enter

Commands are **case insensitive**.

The Matrix will reply **OK** once string is correct, **NG** in case of incorrect string

HDBaseT IR Function:

1. Use IR01 (remote control) to control the Matrix input port switching from receiver side.
(Work with IR-CR01 IR receiver cable). See chap. 4.5
2. Using remote control of source device or TV, to control source device or TV.
(Work with IR-CT01 IR emitter cable, IR-CR01 IR receiver cable).

HDBaseT linking cable:

Recommend to use high quality Cat.5e 、Cat.6 、Cat.6a UTP / STP or FTP cable.
AWG24 or AWG23 solid type is recommended.

HDBaseT transmission distance:

Transmission distances up to 100 meters with AWG24 cable. Using a lower resolution won't extend to longer distance.

If the CAT5e/6 cable connections go through wall socket from the wall outlet to HE02R receiver, the cable length must less 5 meters between HE02R receiver and wall socket. The wiring diagram as below:

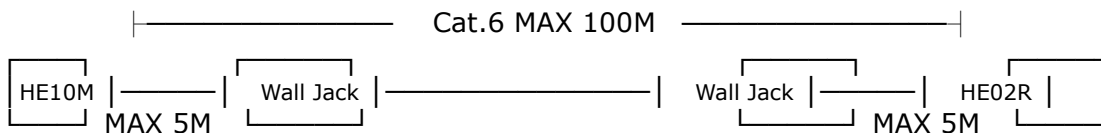

HDBaseT RJ45 Pin Define:

Video Link (TIA/EIA-568-B)

- | | |
|-----------------|---------|
| 1. Orange-white | DATA0 + |
| 2. Orange | DATA0 - |
| 3. Green-white | DATA1 + |
| 4. Blue | DATA2 + |
| 5. Blue-white | DATA2 - |
| 6. Green | DATA1 - |
| 7. Brown-white | DATA3 + |
| 8. Brown | DATA3 - |

Caution:

1. First time to use HE10M remote control or change new batteries must set up IR ID.
2. The wiring must away from any equipment with electromagnetic wave, i.e.: microwave, mobile phone, radio equipment, high voltage, Fluorescent light fixtures, power lines, etc.
3. HDBaseT not regular network device, do not connect with any networking equipments to avoid damage.
4. IP Address, Subnet Mask, Gateway, DHCP Client, Media Type, MAC Filter setting made by HE10M ETHERNET MENU.
5. HDBaseT IR operation: Do not make IR emitter and receiver cable too close, to avoid interference and caused wrong operation.
6. HDBaseT RS232 under distribution mode: it not able to send two devices simultaneously.

7. Web Control Function:

Initial IP Configuration

1. Setup MATRIX IP Address same as your PC with same domains.(Default 192.168.0.200)
MATRIX IP Address method, please refer. to “ETHERNET” Chapter
2. Input IP Address on a web page, you could link to the Web UI of the MATRIX host.
3. Web UI Operation :

SWITCH SETTING:

MATRIX

SWITCH SETTING

MATRIX-01

Power	Output	Input	
Power Off ▾	Output 1	Input 1 ▾	Reload
	Output 2	Input 2 ▾	Advanced
	Output 3	Input 3 ▾	
	Output 4	Input 4 ▾	Apply
	Output 5	OFF	
	Output 6	Input 1	
	Output 7	Input 2	
	Output 8	Input 3	
	Output 9	Input 4	
	Output 10	Input 5	
		Input 6	
		Input 7	
		Input 8	
		Input 9	
		Input 10	

- **Power** : Control MATRIX power on and standby.
- **Output** : Display output 1~10, it can change the display name by the Aliases page.
- **Input** : Display input 1~10, this field is a drop down menu, this field is a drop-down menu, a drop-down menu include Input 1 ~ 10 and OFF, It can change the display name by the Aliases page.
- **Reload** : Get MATRIX host message.
- **Advanced** : Enter into the “Advanced” page.
- **Apply** : Complete the setting

Advanced:

MATRIX	
Advanced	
IP address	192.168.0.10
Subnet mask	255.255.255.0
Gateway IP	192.168.0.1
Media Type	Auto detect ▼
DHCP Client	Disable ▼
Auto Reset (No data input)	2 (1 ~ 255 Minute)
Device Name	MATRIX-01

MAC address 00-60-3D-56-E3-13 OnLine 0

[Memory](#) [MAC Filter](#) [Aliases](#) [Back](#) [Apply](#)

- **IP address** : Change **IP address**
- **Subnet mask** : Change **Subnet mask**
- **Gateway IP** : Change **Gateway IP**
- **Media Type** : Change **10 / 100 / Auto detect**
- **DHCP Client** : When setup at **Enable**, the MATRIX host will automatic get **IP Address** 、**Subnet Mask** 、**Gateway**, If setup at **Disable**, the **MATRIX** host **IP Address** 、**Subnet Mask** 、**Gateway** need to set from Advanced page.
- **Auto Reset** : The terminal connection people will be 4 users on line at same time, this function could setup the linking time to avoid long time linking and other user can not used. When over the setting link time, the terminal will automatically disconnect the link. . (0: no time setup, 1 ~ 255 Minute time range that can be setup)
- **Memory** : Click to enter **Memory** setup page
- **MAC Filter** : Click to enter **MAC Filter** setup page
- **Aliases** : Click to enter **Aliases** setup page
- **Device Name** : Can change device name
- **Back** : Back to **SWITCH SETTING** page
- **Online** : Terminal connection users display, the max. 4 users on line.

Aliases:

Output		Input	
Output 1	<input type="text" value="Output 1"/>	Input 1	<input type="text" value="Input 1"/>
Output 2	<input type="text" value="Output 2"/>	Input 2	<input type="text" value="Input 2"/>
Output 3	<input type="text" value="Output 3"/>	Input 3	<input type="text" value="Input 3"/>
Output 4	<input type="text" value="Output 4"/>	Input 4	<input type="text" value="Input 4"/>
Output 5	<input type="text" value="Output 5"/>	Input 5	<input type="text" value="Input 5"/>
Output 6	<input type="text" value="Output 6"/>	Input 6	<input type="text" value="Input 6"/>
Output 7	<input type="text" value="Output 7"/>	Input 7	<input type="text" value="Input 7"/>
Output 8	<input type="text" value="Output 8"/>	Input 8	<input type="text" value="Input 8"/>
Output 9	<input type="text" value="Output 9"/>	Input 9	<input type="text" value="Input 9"/>
Output 10	<input type="text" value="Output 10"/>	Input 10	<input type="text" value="Input 10"/>

- **Aliases** page can change input/output name, enter **Apply** to finish the setting after change
The new name will update and correspond to **SWITCH SETTING** page **Output / Input**.
- Press **Back** jump back to **advanced** page.

MAC Filter:

MAC Filter	Enable <input type="button" value="v"/>
MAC address 1	<input type="text" value="11-22-33-44-55-66"/>
MAC address 2	<input type="text" value="00-00-00-00-00-00"/>
MAC address 3	<input type="text" value="00-00-00-00-00-00"/>
MAC address 4	<input type="text" value="00-00-00-00-00-00"/>
MAC address 5	<input type="text" value="00-00-00-00-00-00"/>
MAC address 6	<input type="text" value="00-00-00-00-00-00"/>
MAC address 7	<input type="text" value="00-00-00-00-00-00"/>
MAC address 8	<input type="text" value="00-00-00-00-00-00"/>
MAC address 9	<input type="text" value="00-00-00-00-00-00"/>
MAC address 10	<input type="text" value="00-00-00-00-00-00"/>

- **MAC Filter** can be setup as registered **MAC Address** to link **MATRIX host Web UI** , the max. up to 10 groups **MAC Address**
- After **MAC Address** fill in, select **Enable** and press **Apply** to complete the setting.
- Press **Back** jump to **advanced** page.

MEMORY:

The screenshot shows a web interface titled "MATRIX" with a sub-section "Memory". Under "Memory", there are two columns of buttons: "Save" and "Load". The "Save" column contains buttons labeled "Save1" through "Save10". The "Load" column contains buttons labeled "Load1" through "Load10". Below these columns is a "Back" button.

Save		Load	
Save1	Save6	Load1	Load6
Save2	Save7	Load2	Load7
Save3	Save8	Load3	Load8
Save4	Save9	Load4	Load9
Save5	Save10	Load5	Load10

Back

- **Save** : Save 10 set of channel settings
- **Load** : Reload 1 of the channel settings
- **Back** : Back to **Advanced** page

8. Android APP Function:

Google Play Download Link

<https://play.google.com/store/apps/details?id=sct.com.matrixcontroller>

Google Play Download QR code



System Setting

Connect mobile phone to Wi-Fi and set the IP/ subnet mask same with matrix network segment

Default IP address of 10 by 10 matrix is 192.168.0.10

Default IP address of 4 by 4 matrix is 192.168.0.200

Default subnet mask is 255.255.0.0

You could also set to DHCP mode, please refer user manual

There are two ways to get the IP address of matrix:

1. Use APP function: Scan Device to get the IP address.
2. Use panel button or IR remote control by press [MENU], select to [ETHERNET] function and press [ENTER] to enter [IP Address] function than press [ENTER], it will show IP Address in the LCD panel of matrix

Main Page:



When first time enter the APP will see the main page

Bottom left 「+」 to add matrix

Bottom right 「Info」 to show information

Scan Device

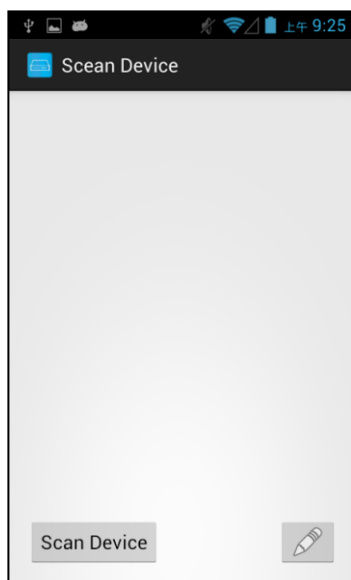

Touch 「+」 button at main screen to enter 「Scan Device」 page

Touch bottom left 「Scan Device」 to start scan

Touch bottom right pen icon to input the IP address manually

Add Matrix

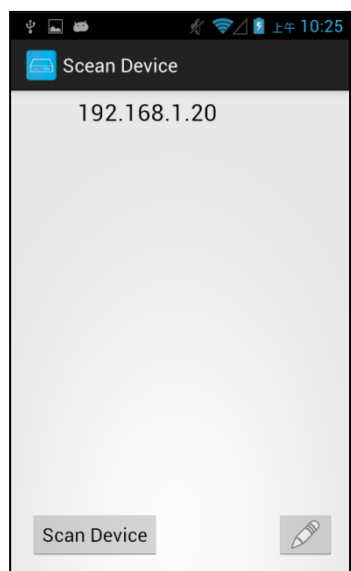

After scanning it will show all matrixes in the list

Touch the IP in list to enter 「Add Device」 page

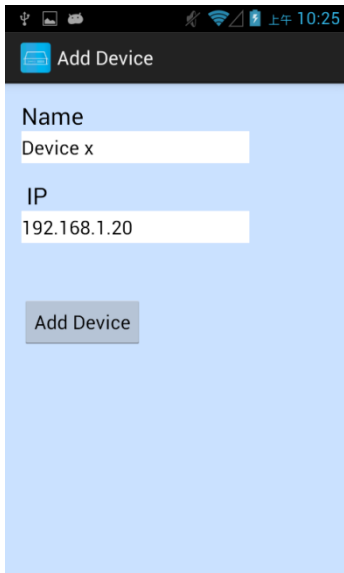

Enter the name of matrix then touch 「 Add Device 」 to finish setting
Notice : Name should be unique, not allow duplicate

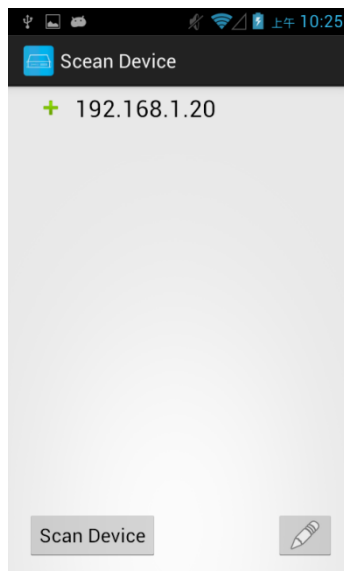

It will show 「 + 」 icon in front of the IP address when finished

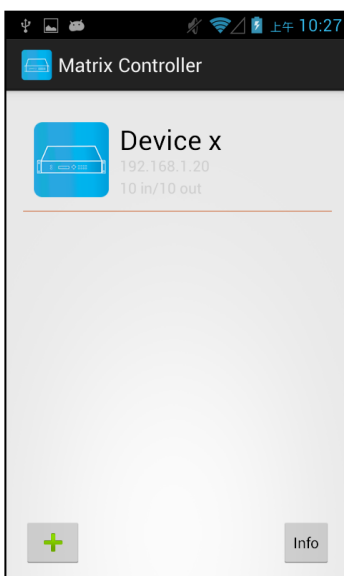

Return to main screen you will see the matrix which just add

Modify Device

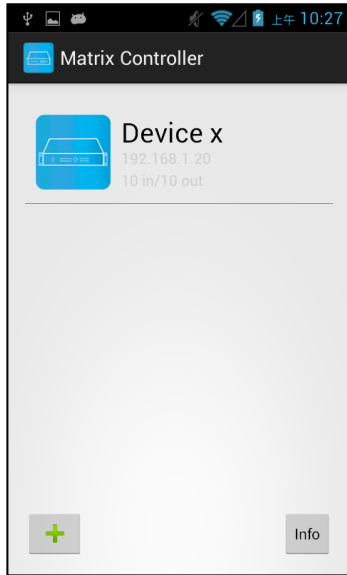

Press the matrix name to show pop-up dialog

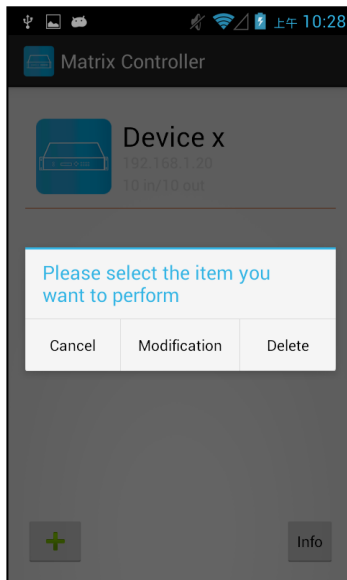

Touch 「Modification」 to enter modification page.

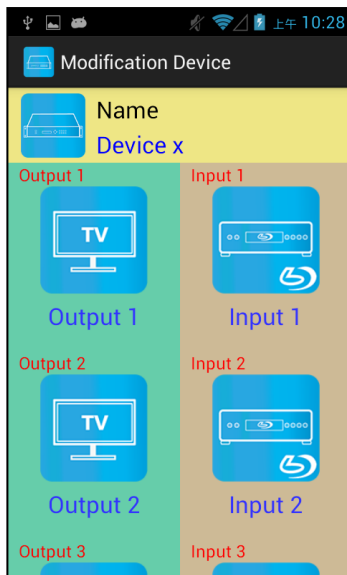

Yellow block shows matrix name and icon

Green block shows name and icon of output devices

Brown block shows name and icon of input devices

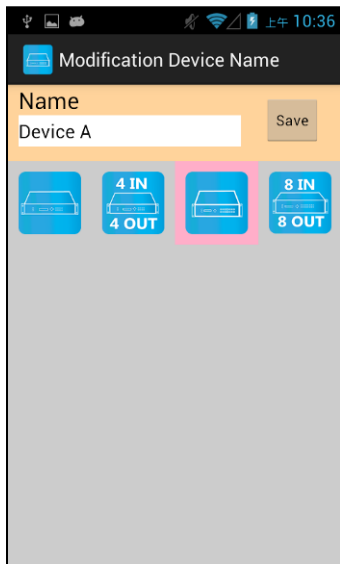

Touch yellow block to modify matrix name and icon

Input the name and select the icon you prefer then touch 「 Save 」 to finish

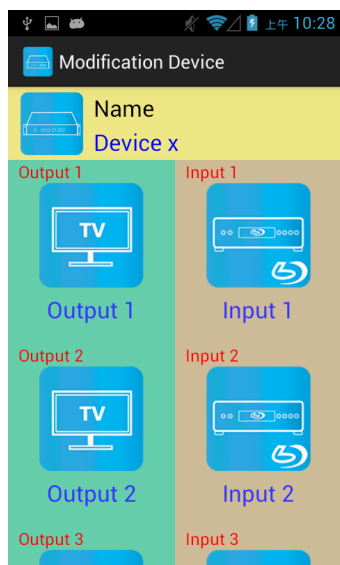

Return to Modification page you will see the matrix have been changed



Touch green block to modify output name and icon

Input the name and select the icon you prefer then touch 「 Save 」 to finish

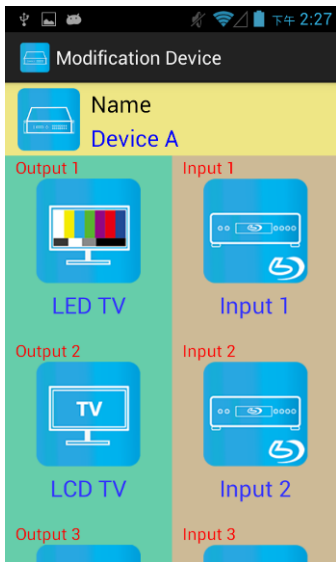

Return to Modification page you will see the output have been changed



Touch brown block to modify input name and icon
 Input the name and select the icon you prefer then touch 「 Save 」 to finish

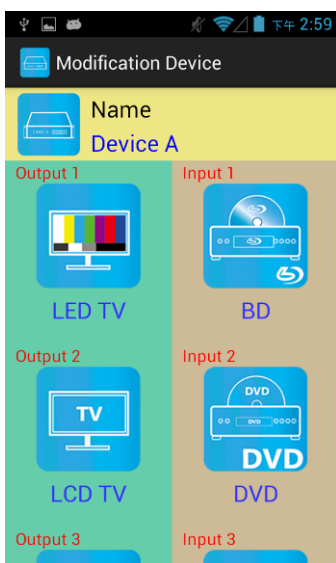

Return to Modification page you will see the input have been changed

Output Channel Switching

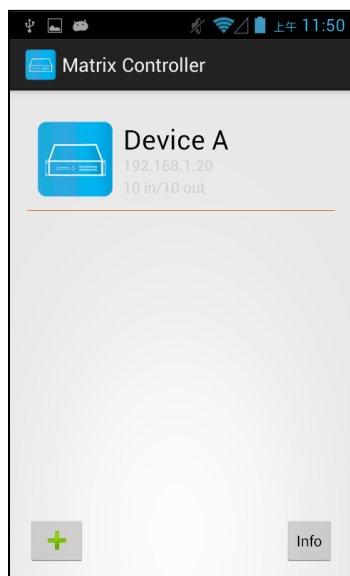

Left : icon for matrix

Center upper big font for matrix name,

Center middle small font for matrix IP

Center lower small font for matrix type (4 by 4 or 10 by 10)

Notice: if shows 「Specify the host does not exist」 means the matrix not exist

Touch the block of matrix to enter Controller page



Top right 「Refresh」 to renew the status of matrix

Below 「Refresh」 button to power on/off the matrix

The block under device are Output 1~ Output 10
(4 by 4 matrix only shows Output 1~Output 4)

Left side shows output device name

Right sideshows current input device name

Bottom left 「Save Scene」 to save the scenes

Bottom right 「Load Scene」 to load the scenes



Touch output block to enter Channel Selection page



Touch input device to switch or ON/OFF icon to power on/off



It will return to Controller page after switching and refresh the status of channel

Save Scene



In Controller page touch bottom left 「 Save Scene 」 to enter Save Scene page



Touch the Scene column to show pop-up dialog

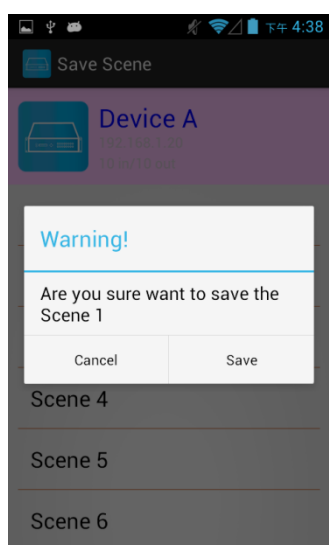

Touch 「 Save 」 to save current channels setting for all output
It will return to Save Scene page automatically.

Notice: if it shows " Please update device firmware" means your matrix do not support this function, please upgrade your firmware to enable this function

Load Scene



In Controller page touch bottom right 「Load Scene」 to enter Load Scene page

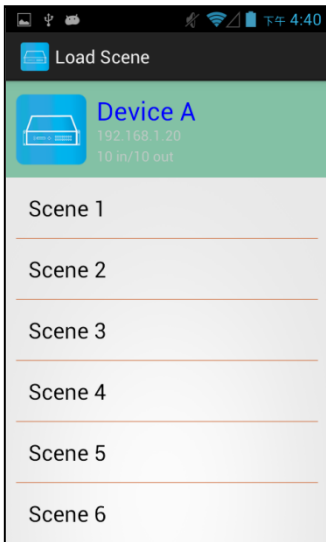

Touch scene column to load saved channels setting for all output
It will return to Load Scene page automatically. (Default is Output 1 to Input 1, Output 2 to Input 2 and so on...)

Notice: if it shows " Please update device firmware" means your matrix do not support this function, please upgrade your firmware to enable this function

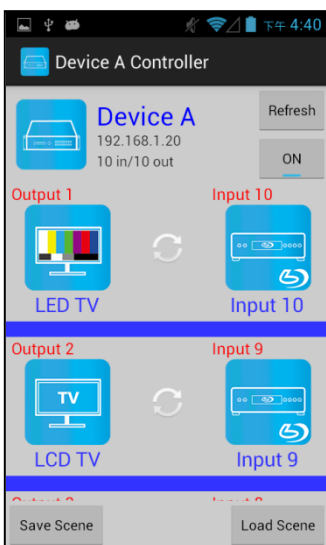

It will return to Controller page after switching and refresh the status of channel

Delete Matrix

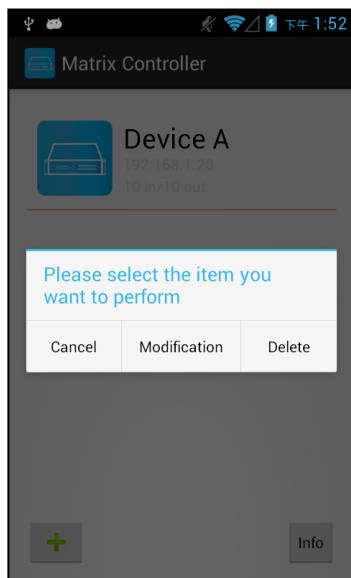

Press the block of matrix in Controller page to show pop-up dialog then touch 「Delete」

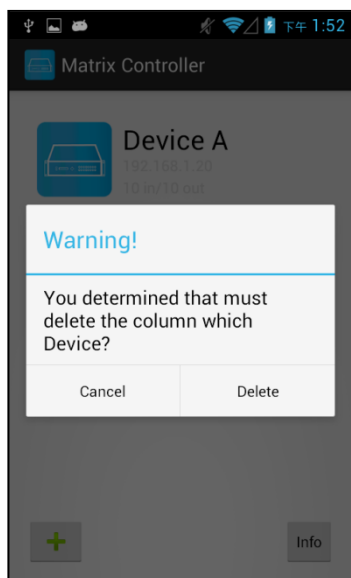

Touch 「Delete」 to delete the matrix

9. iOS APP Function:

iTunes Download Link

<https://itunes.apple.com/us/app/matrix-control/id904487754?l=zh&ls=1&mt=8>

iTunes Download QR code



System Setting

Connect mobile phone to Wi-Fi and set the IP/ subnet mask same with matrix network segment

Default IP address of 10 by 10 matrix is 192.168.0.10

Default IP address of 4 by 4 matrix is 192.168.0.200

Default subnet mask is 255.255.0.0

You could also set to DHCP mode, please refer user manual

There are two ways to get the IP address of matrix:

1. Use APP function: Scan Device to get the IP address.
2. Use panel button or IR remote control by press [MENU], select to [ETHERNET] function and press [ENTER] to enter [IP Address] function than press [ENTER], it will show IP Address in the LCD panel of matrix

Main Page



When first time enter the APP will see the main page

Top left 「+」 to add matrix

Top right 「Edit」 to enter delete mode

Bottom right 「Info」 to show information

Scan Matrix



Touch 「+」 button at main screen to enter 「Scan Device」 page

Touch bottom left 「Scan Device」 to start scan

Touch bottom right pen icon to input the IP address manually

Add Matrix

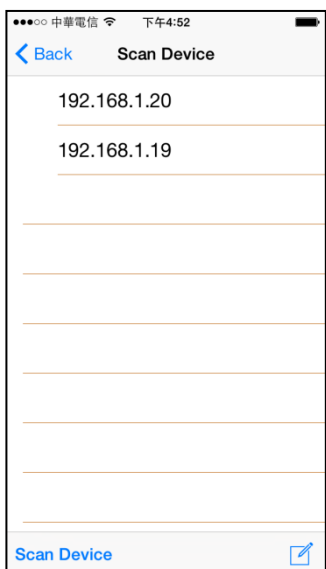

After scanning it will show all matrixes in the list

Touch the IP in list to enter 「Add Device」 page

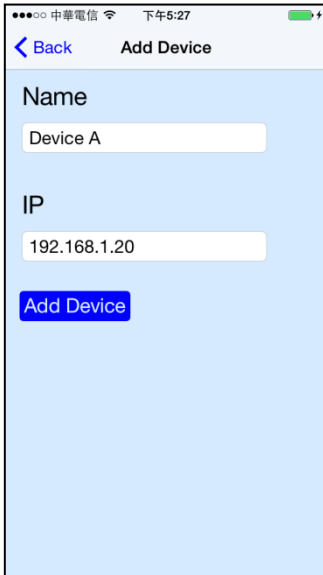

Enter the name of matrix then touch 「 Add Device 」 to finish setting
Notice : Name should be unique, not allow duplicate

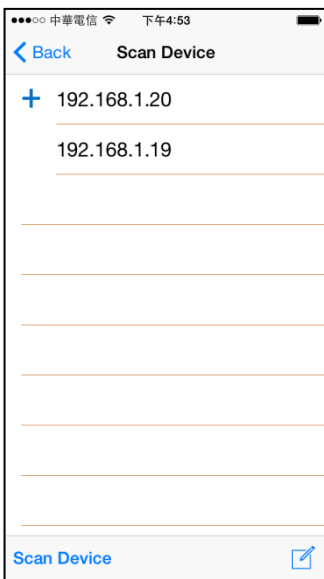

It will show 「 + 」 icon in front of the IP address when finished

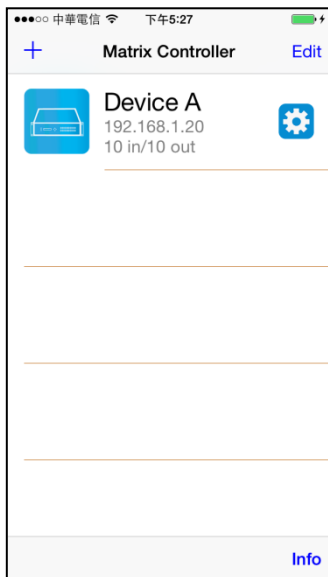

Return to main screen you will see the matrix which just add

Modify Device

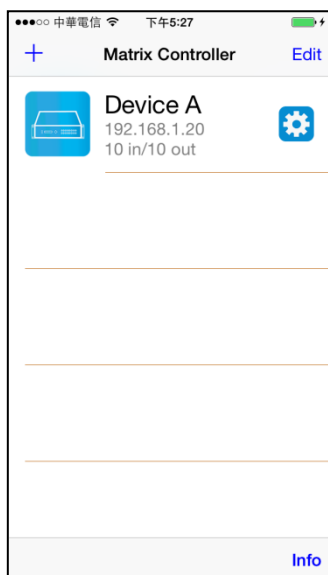

Touch the gear icon to enter Modification page

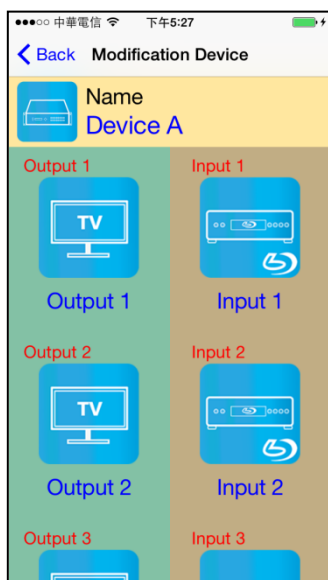

Yellow block shows matrix name and icon

Green block shows name and icon of output devices

Brown block shows name and icon of input devices

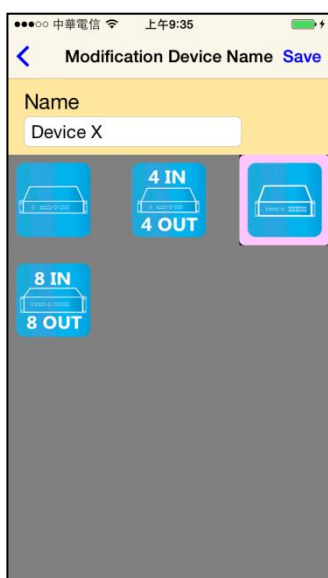

Touch yellow block to modify matrix name and icon

Input the name and select the icon you prefer then touch 「 Save 」 to finish

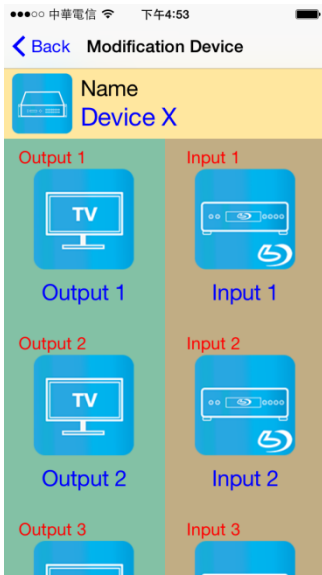

Return to Modification page you will see the matrix have been changed



Touch green block to modify output name and icon
 Input the name and select the icon you prefer then touch 「 Save 」 to finish

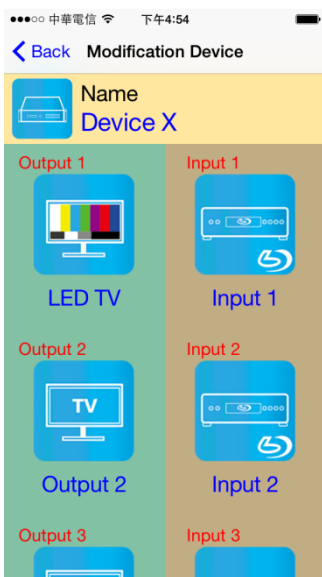

Return to Modification page you will see the output have been changed



Touch brown block to modify input name and icon

Input the name and select the icon you prefer then touch 「Save」 to finish

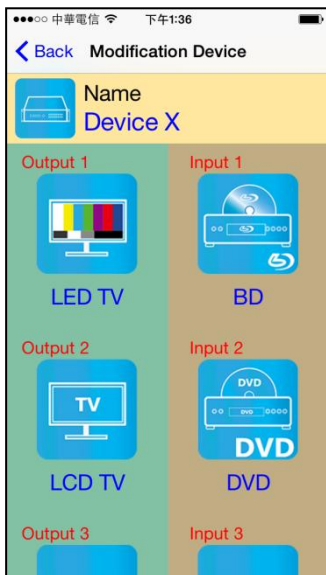

Return to Modification page you will see the input have been changed

Output Channel Switching

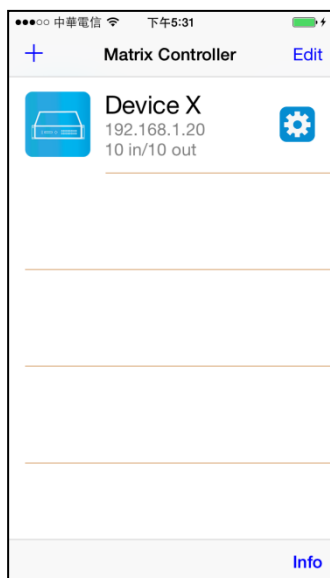

Left: icon for matrix

Center upper big font for matrix name,

Center middle small font for matrix IP

Center lower small font for matrix type (4 by 4 or 10 by 10)

Right gear icon: enter Modification page

Notice: if shows 「Specify the host does not exist」 means the matrix not exist

Touch the block of matrix to enter Controller page

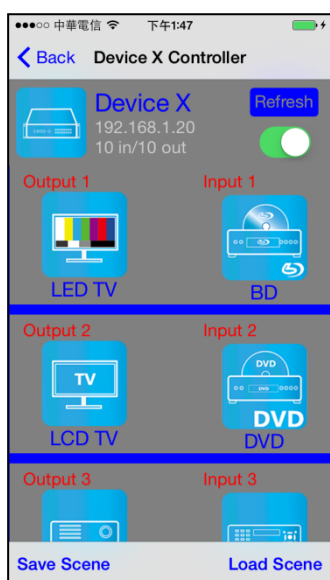

Top right 「Refresh」 to renew the status of matrix

Below 「Refresh」 button to power on/off the matrix

The block under device are Output 1~ Output 10

(4 by 4 matrix only shows Output 1~Output 4)

Left side shows output device name

Right sideshows current input device name

Bottom left 「Save Scene」 to save the scenes

Bottom right 「Load Scene」 to load the scenes



Touch output block to enter Channel Selection page

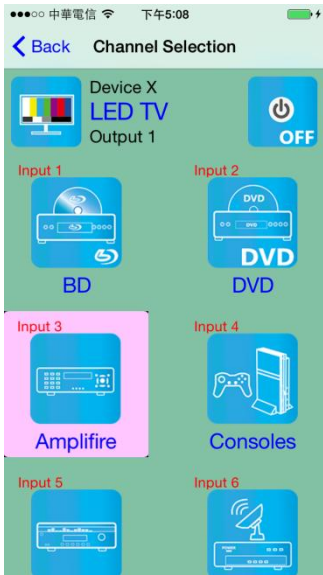

Touch input device to switch or ON/OFF icon to power on/off



It will return to Controller page after switching and refresh the status of channel

Save Scene

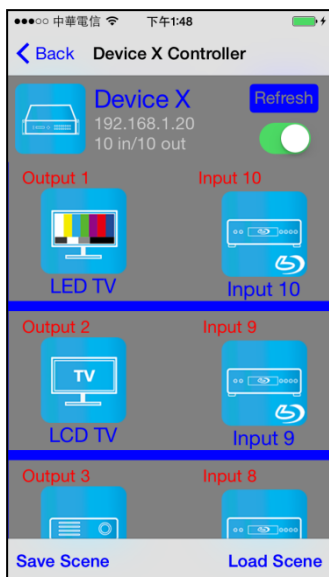

In Controller page touch bottom left 「Save Scene」 to enter Save Scene page

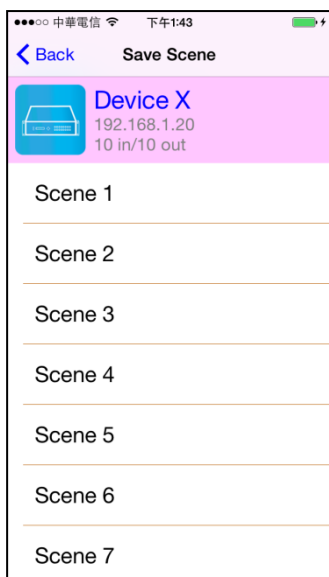

Touch the Scene column to show pop-up dialog

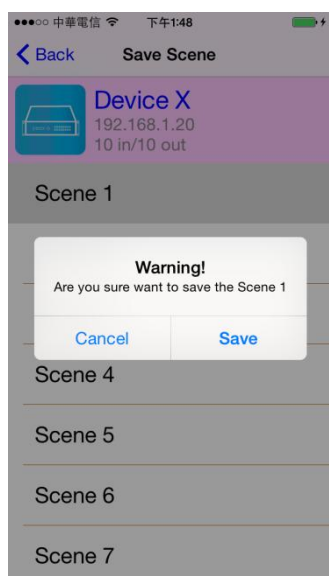

Touch 「Save」 to save current channels setting for all output
It will return to Save Scene page automatically.

Notice: if it shows “Please update device firmware” means your matrix do not support this function, please upgrade your firmware to enable this function

Load Scene

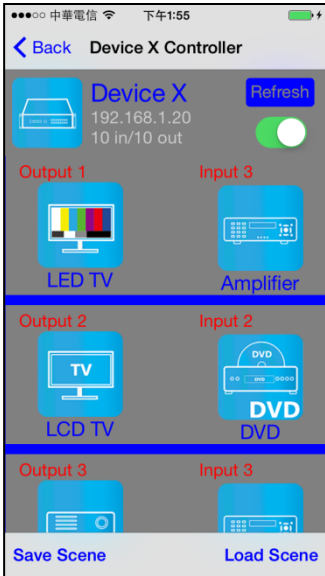

In Controller page touch bottom right 「Load Scene」 to enter Load Scene page

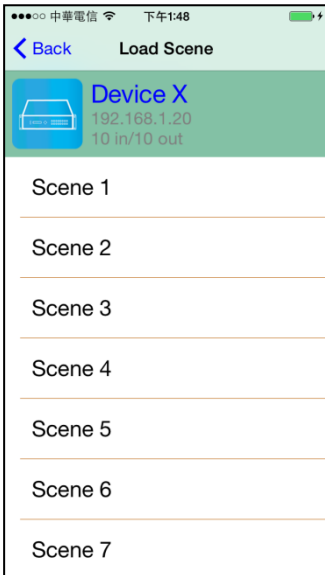

Touch scene column to load saved channels setting for all output
It will return to Load Scene page automatically. (Default is Output 1 to Input 1, Output 2 to Input 2 and so on...)

Notice: if it shows " Please update device firmware" means your matrix do not support this function, please upgrade your firmware to enable this function

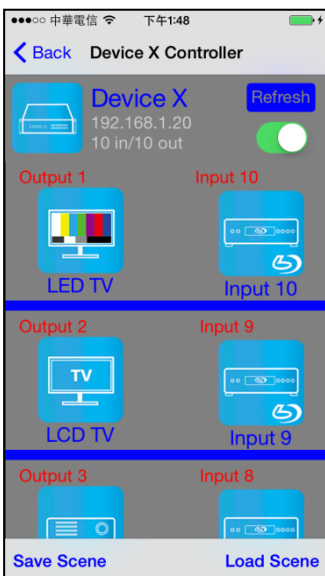

It will return to Controller page after switching and refresh the status of channel

Delete Matrix

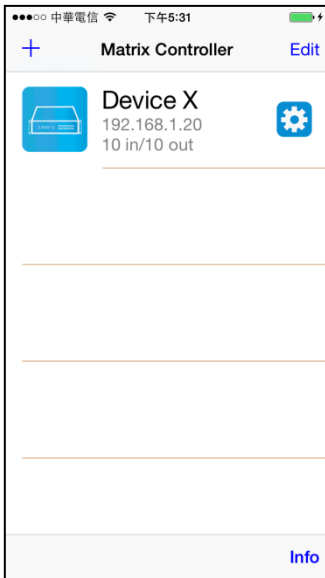

Touch top right 「Edit」 button to enter delete mode

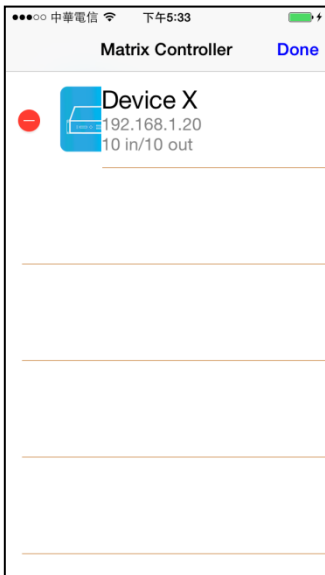

Touch 「-」 button in the left of matrix

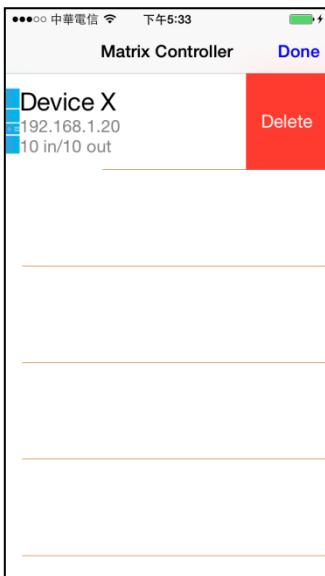

Touch 「Delete」 to delete the matrix

Touch top right 「Done」 to exit

Specification:

ITEM NO	HE10M
HDMI Video Support	4096x2160p@24/25/30Hz 8bit RGB444, 1080p@60Hz 12bit, 3D
HDMI Audio Support	Up to LPCM 7.1 192KHz、Dolby TrueHD、DTS-HD MA
Video Input Interface	HDMI Type A x 8, HDBaseT x 2
Video Output Interface	HDBaseT x 8, HDMI Type A x 2
RS-232 Input/Output Interface	DB9 x 1(CONSOLE)
IR Receive Angle	± 45 degree
IR Receive Distance	5M
Power Adapter	DC 24V 9A
Power Consumption	8A
Temperature	Operation: 0 to 55°C, Storage: -20 to 85°C, Humidity: up to 95%
Dimension mm	483 x 197 x 88
Weight g	5000

ITEM NO.	HE02NR	HE02R	HE02ER	HE02EIR
HDMI Connector	HDMI Type A x 1			
HDMI Video Support	4096x2160p@24/25/30Hz 8bit RGB444, 1080p@60Hz 12bit, 3D			
HDMI Audio Support	Up to LPCM 7.1 192KHz、Dolby TrueHD、DTS-HD MA			
HDBaseT Connector	RJ45 x 1			
MAX HDBaseT Distance	100M			50m by CAT5e/6 70m by CAT6a
RS-232 Baud Rate	Up to 115200 bps / Full Duplex	Up to 115200 bps / Full Duplex	X	X
RS-232 Connector	DB9 Male	DB9 Male	X	X
Ethernet Connector	RJ45 x 1	X	X	X
Ethernet Data Rate	10 / 100Mbps	X	X	X
Ethernet Distance	100M (Max)	X	X	X
IR Carrier Frequency	30-60KHz	30-60KHz	X	30-60KHz
IR Angle	±55	±55	X	±55
IR Distance	5m	5m	X	5m
Digital Audio Connector	Optical (TOSLINK) RX	X	X	X
Power Supply	DC 5V 2AMP Regulated			
Power Consumption	1200mA (Max)			820mA (Max)
Temperature	Operation: 0 to 55°C, Storage: -20 TO 85°C, Humidity: up to 95%			
Dimension mm	88 x 120 x 30	88 x 130 x 30	49 x 92.3 x 25	49 x 92.3 x 25
Weight g	280	270	135	135



Rev. B