

4 CH Vehicle Mobile DVR



User Manual

2011 NOV V1.1

■ optional

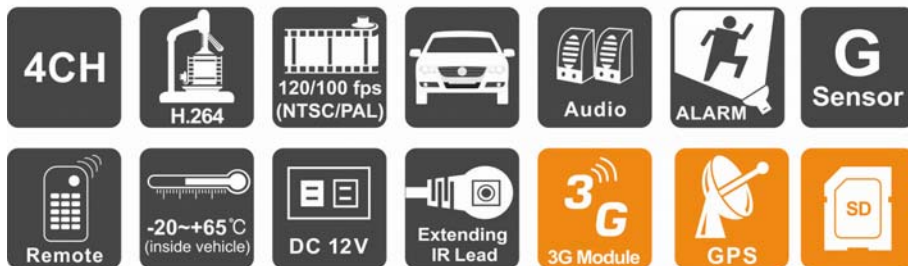

Index

A. Features.....	1
B. Specification.....	2
C. Product Appearance	3
D. Product Dimension	4
E. Record / Stop-Record	5
F. System operating instruction.....	6
G. Playback.....	12
H. Format Memory Card.....	21
I. Restoring Memory Card	24
J. 3G-SIM Card Setting (with 3G Module).....	26

A. Features

- Max. up to 4 CH vehicle cameras, can take record for inside and outside the vehicle.
- Video output for live view, playback with monitor.
- H.264 Compression format.
- Recording format : D1 and CIF.
- Build-in single channel microphone.
- Quick Search Overall Event Log.
- The full recording time and date can be showing in the monitor directly.
- Auto-Record after memory card Plug-in and Power Supplied.
- Data Store in SD card for better safety and anti-vibration performance.
- 4 sets of alarm input ports, built-in buzzer.
- Support Record Video with audio, video, G-sensor and GPS data at the same time.
- Optional for 3G module, control the driving status and data at any time.

B. Specification

Items		Description	
Video format		NTSC	PAL
Video input		4CH Input	
Audio input		1CH Input	
Video output		1CH output	
Audio output		1CH output	
Alarm input		4 alarm input	
Alarm output		Buzzer	
Display mode		Full Screen, 4 Split	
Record resolution	highest	D1 720 x 480	D1 720 x 576
	normal	CIF 360 x 240	CIF 360 x 288
Recording Frame		Max. 120 FPS	Max. 100 FPS
Compression Format		H.264 Technology	
Operating system		Embedded Linux	
Single-tasking		Record / Backup	
Recording mode		Full-time recording	
LED indicator		Power, recording, GPIO	
Buzzer		Video Loss	
Storage		SD Card	
Back-up system		CarBox Player	
Firmware upgrade		SD Card	
Multi-language		English /Simplified Chinese /Traditional Chinese	
G-SENSOR		Yes	
3G-module		CDR-E10-3G: USB 3G dongle CDR-E10-3GA: build-in 3G module	
GPS position		YES(CDR-E10-3G, CDR-E10-3GA)	
Control method		IR remote controller	
Power supply		DC+12V / 500mA (not including Cameras)	
Dimension		115mm x 132.7mm x 30mm (W x D x H)	
Weight		0.4kg (including SD card)	
Operation Temperature		-20°C ~ +65°C (inside vehicle)	
Accessories	Standard	Main Machine, 3 Pin Power Cable, Alarm Cable, 3M Extending IR Lead, Remote Control, Microphone, Driver CD, Quick Guide ★.Build-in 3G: Antenna, 1.5M Extension Antenna Cord	
	Optional	3G Module, G-Mouse, SD Card	

C. Product Appearance

Front

(Without 3G module and 3G USB dongle)

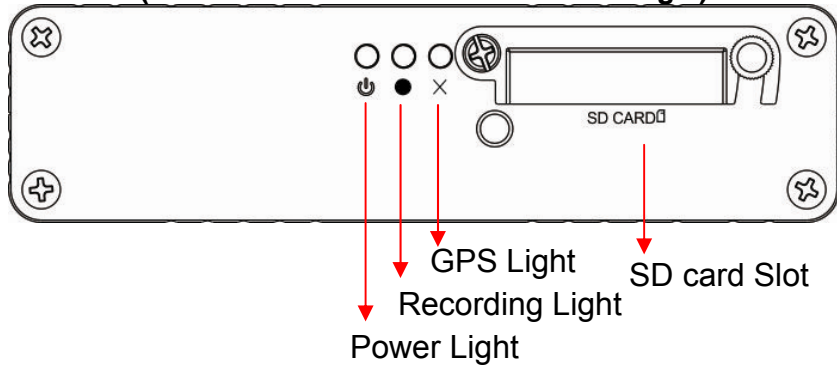

(Build-in 3G module)

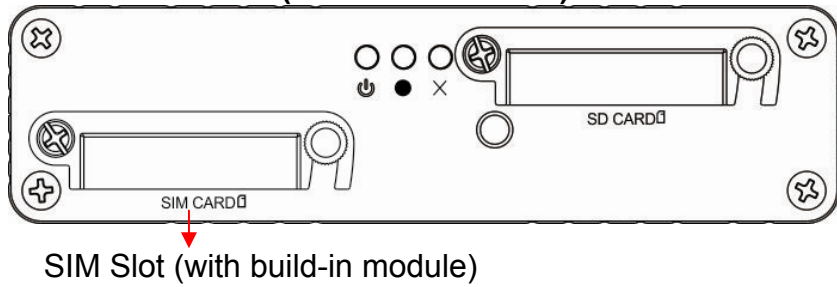

Back

(Without 3G module)

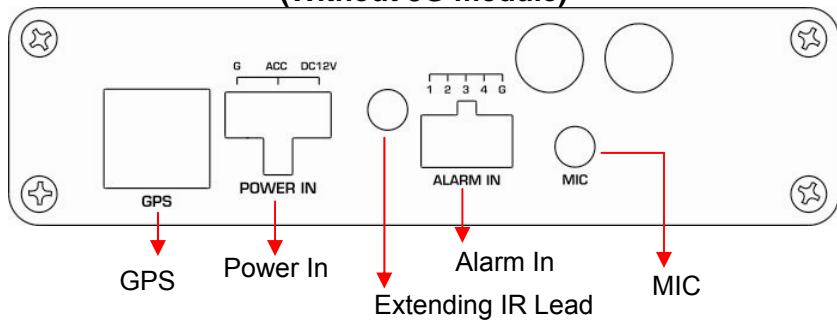

(With 3G USB dongle)

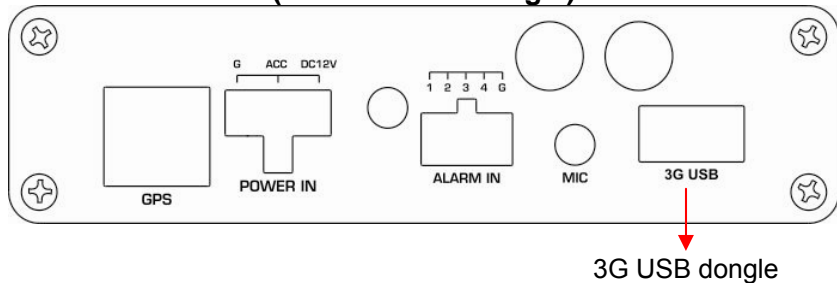

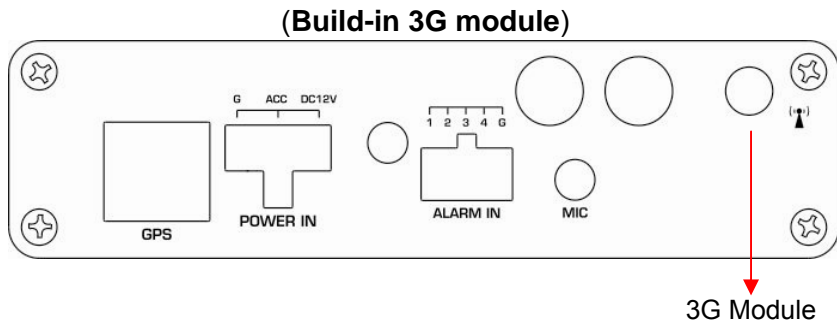

D. Product Dimension

UNIT: mm

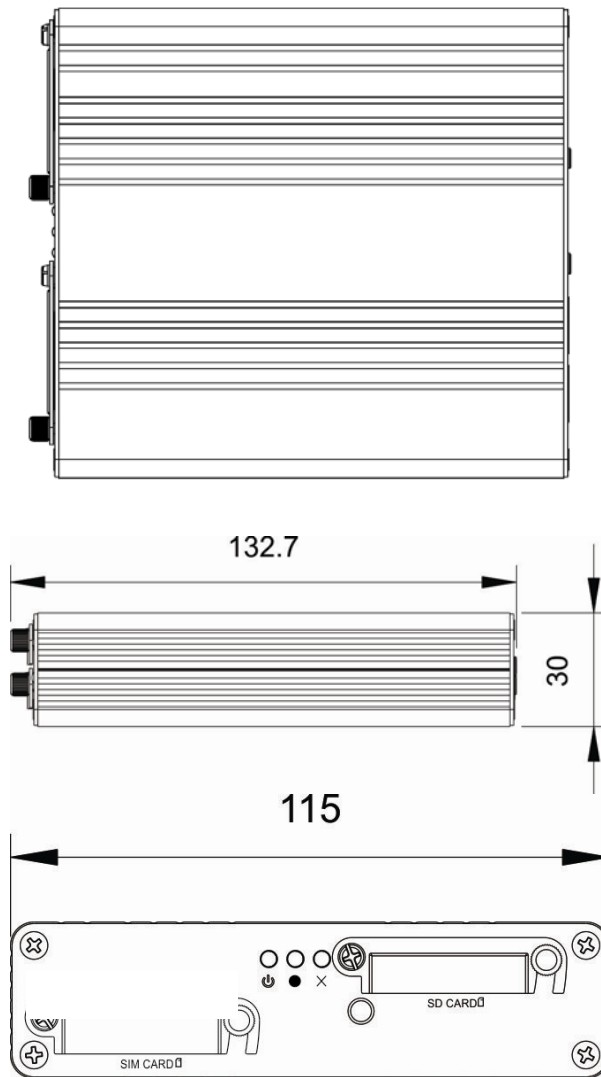

E. Record / Stop-Record

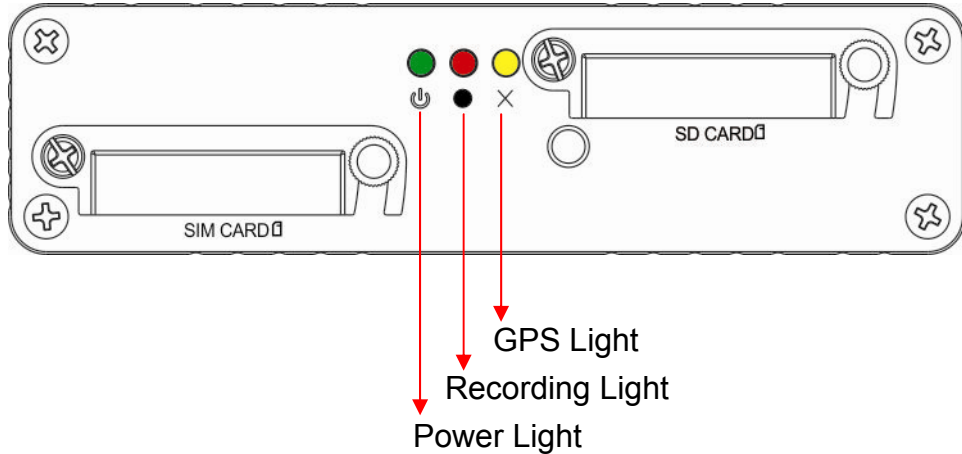

1. Power on / Record

Insert SD card into slot and then power on the machine, waiting about 30 seconds after booting completed.

During the DVR booting up, the record indicator will start flashing as the recording is in progress.

- Green light: light on means power on; light off , means power off.
- Yellow light: Light off means GPS not ready, light on means GPS positioning ready.
- Red light: Red Led flashing means DVR is on recording. Red Led off means No-Record. Red Led flashing quickly means playback file.

★Remark: When DVR is on playback mode, the DVR will stop record.

2. Turn off / Stop record

After Power-off, DVR will stop record, you can remove SD card and plug it to PC to review the file.

F. System operating instruction

Vehicle DVR can be operated through two methods: IR remote controller and PC software application.

1. Through IR Remote controller instruction

1.1. As following is the key mapping table for IR Remote controller :

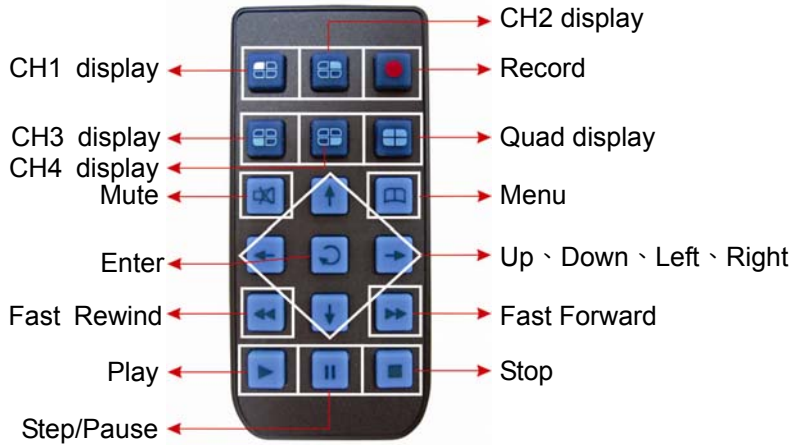

1.2 DVR OSD menu operation and IR Remote controller key mapping chart

■ Main menu page switch

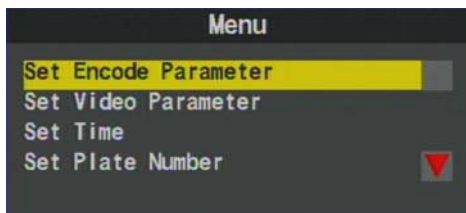

page1/3 setting



page 2/3 setting

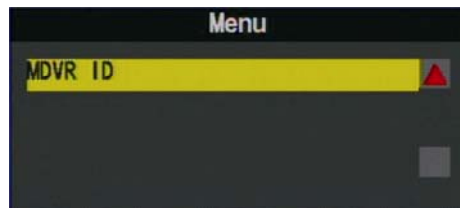

page3/3 (with 3G module)

◆ IR Remote controller Instruction

- (1) Select Item: [up/down/left/right]
- (2) Change setting for selected item: [up/down/left/right]
- (3) Change setting for Bar item : [Enter]
- (4) Full Screen display for each CH: [CH1~CH4]
- (5) Open OSD menu, back to previous page : [menu]
- (6) Quad display : [Quad]
- (7) Enter playback mode : [play]
- (8) Stop Play/exit playback mode : [Stop]
- (9) Suspend recording:[Pause]

■ System Setup instruction

1. Set Encode Parameter

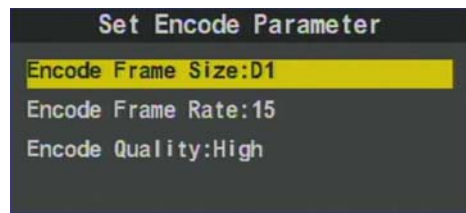
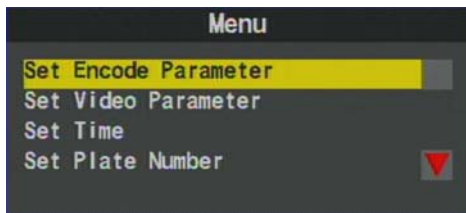

◆ IR Remote controller operating instruction

- (1) Can be selected Resolution/Record frame rate /Recording quality from up/down key on remote controller.
- (2) Left key→ Change parameter.
- (3) Right key→ Back to pervious parameter.

◆ Items Setting

- (1) Encode Frame Size (Res.): D1 / CIF
- (2) Encode Frame Rate: 5/15/20/25/30
(D1 max. 15 / CIF max. 30)
- (3) Encode Quality: Low/Normal/High

2. Set Video Parameter

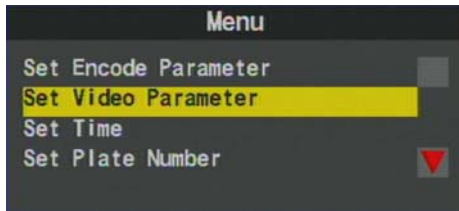

- ◆ IR remote controller operating instruction
 - (1) Up/Down key→ Select current channel for setup
 - (2) Left/Right key→ Set brightness/contrast/hue for current channel (Left key→ To reduce)/ (Right key→ To increase)
- ◆ Item Setting
 - (1) Brightness: (Left key→ to reduce)/ (Right key→ to increase)
 - (2) Contrast: (Left key→ to reduce)/ (Right key→ to increase)
 - (3) Hue: (Left key→ to reduce Hue)/ (Right key→ to increase Hue)

3. Set Time

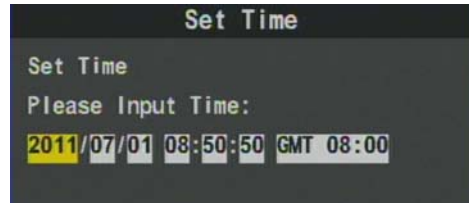
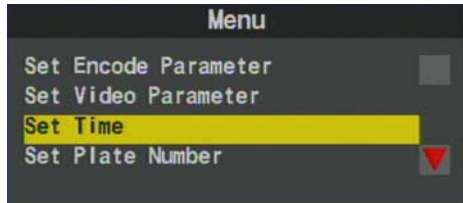

- ◆ IR Remote controller operating instruction
 - (1) Up key→ Plus one , Down key→ Reduce one.
 - (2) Left key→ Left one space, Right key→ Right one space.

4. Set Plate Number

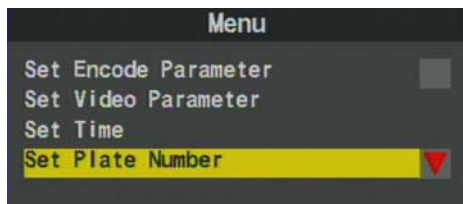

- ◆ IR Remote controller operating instruction
 - (1) Up key→ Numbers plus one or alphabetical order to increase.
 - (2) Down key→ Number reduce one or alphabetical order to reduce
 - (3) Left key→ Left one space.
 - (4) Right key→ Right one space.

5. Delete All Record Data (Format Disk)

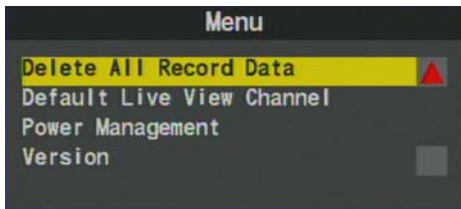

- (1) Delete All Record Data
Use right key or left key to select the selection then click “enter” to confirm.
★Caution! All data will be deleted when you click “Yes”.

6. Default Live View Channel Display

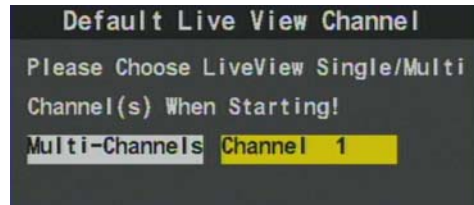
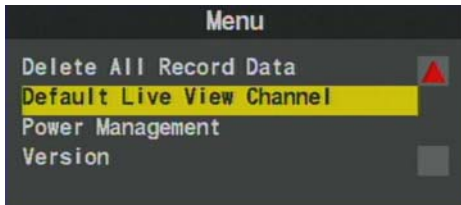

- (1) Select the default live view CH after startup: Item selected will be default live view display mode after DVR booting completed.
- (2) On this page, Use left key or right key to select Quad display (Multi-CH) or CH 1 Display, then press “enter” to confirm.

7. Power Management



- (1) Power Management: Setup Extended Record period after Engine shutdown.
- (2) Use IR Remote controller for setting, Click Left key to move one space for selecting time for delay-recording, then press enter key to confirm.(The delay-recording period can be 0,5,10,15,20 minutes)

8. Check Firmware Version

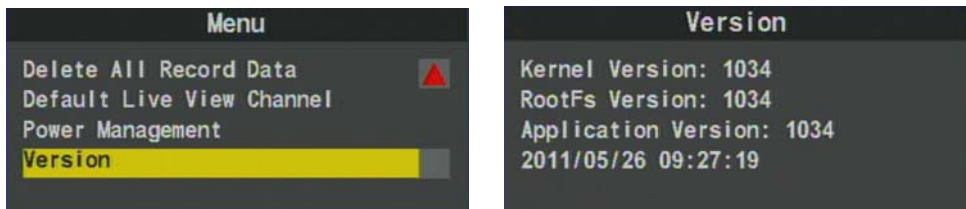

- (1) To check current firmware version, please select version and press enter key.
★Check the current firmware version first before firmware upgraded.

9. Check MDVR ID Information (Only available when DVR with specific 3G module)

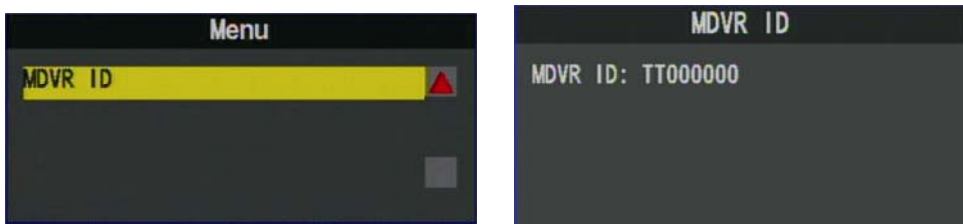

- (1) If you need to check current MDVR ID information, please click MDVR ID and press enter key on remote controller.

★Check the current MDVR ID version is the newest version first before start 3G information setup.

■ LIVE Display



- (1) Select CH1~CH4 to full display mode; If you want to return to quad display, please press quad key.
- (2) On Live view mode, click “menu” to enter OSD menu or click “Play” to enter playback mode.

★If it shows the “G” mark on Upper right screen, it means GPS positioning successes.

■ Playback mode





Select Decode Items	
Start Record Time	End Record Time
2011/06/30 16:00:46	2011/06/30 17:05:13
2011/06/30 17:05:13	2011/06/30 18:09:41
2011/06/30 18:09:42	2011/06/30 19:14:05
2011/06/30 19:14:06	2011/06/30 20:18:30
2011/06/30 20:18:30	2011/06/30 21:22:53
2011/06/30 21:22:54	2011/06/30 22:27:14
Page 00001	Total Pages 00003

- (1) Select CH1~CH4 as full display for each CH; If you want to return to quad display, please press quad key.
- (2) On Playback mode, please click “stop” to exit the playback mode.
- (3) Press pause key to pause video stream.
- (4) On Pause mode, Press the play key to continue play recording file.

G. Playback

1. Through Carbox Player on PC site

(1) Use SD card to playback directly

Execute the CarBox2.exe  from CD-ROM , the display as showing below. Click  Play button to select memory card; or click open file  to choose the files from memory card or hard disk, and then double-click the file you want to play. Under playing mode the  play key will switch to  pause key.

★Caution: It needs to install DirectX 9.0 or above before running CarBox2 software.

Operating instruction

■ Viewer interface schematic















★GPS Coordinate, Speed and Google Map (select models with 3G modules)

a. Control interface description



1		Previous File
---	---	---------------

2		Previous Frame
3		Backward Play
4		Pause
5		Stop
6		Play
7		Next Frame
8		Next file
9		Open folder, select file.
10		Disk backup. Select the backup path for file storage.
11		Google Map
12		Configuration
13		Snapshot
14		Tool, SD card format, language setting.

■ Hard Disk backup 

Review footage on the SD card through PC, Click” ”, then it will pop-up as following backup dialogue windows.

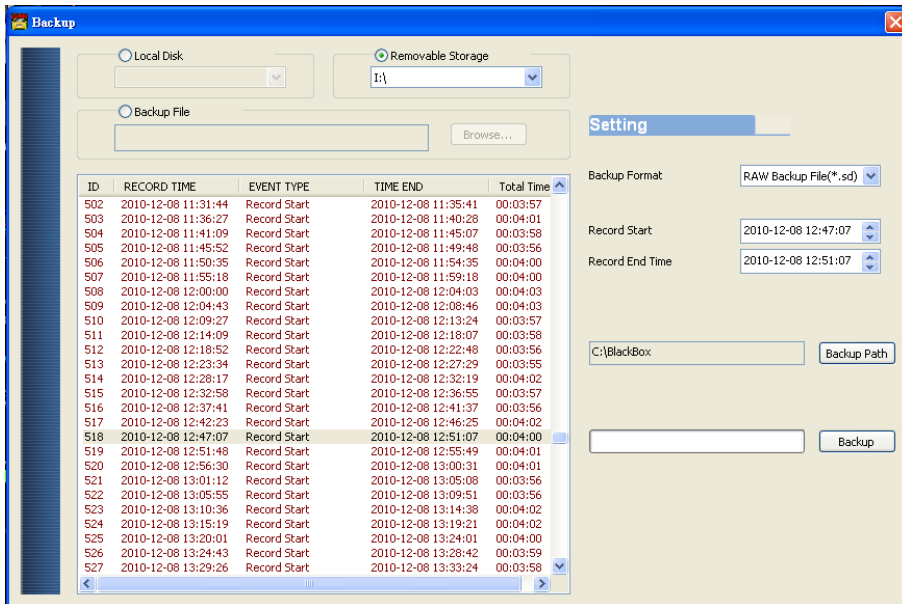

Step 1. Select the SD card drive no.

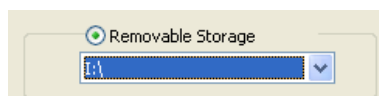

Step 2. Select the recorded file which you want to backup

ID	RECORD TIME	EVENT TYPE	TIME END	Total Time
1	2010-11-13 06:23:32	Record Start	2010-12-07 00:54:20	570:30:48
2	2010-12-07 00:55:04	Record Start	2010-12-07 00:57:54	00:02:50
3	2010-12-07 00:58:38	Record Start	2010-12-07 01:01:29	00:02:51
4	2010-12-07 01:02:14	Record Start	2010-12-07 01:05:05	00:02:51
5	2010-12-07 01:05:49	Record Start	2010-12-07 01:08:40	00:02:51
6	2010-12-07 01:09:24	Record Start	2010-12-07 01:12:15	00:02:51

Step 3. Select the Backup Format

Backup Format: RAW Backup File(*.sd) [v]
 Record Start: 2010-12-07 00:58:38 [v]
 Record End Time: 2010-12-07 01:01:29 [v]

Backup format:

(1) RAW backup file. Specific .sd format

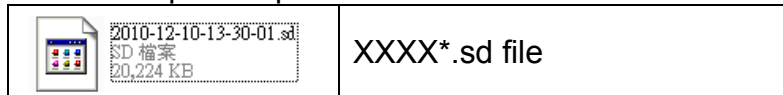

(2) AVI File(*.avi) backup when take this format as backup



★caution : The difference between .sd format and .avi format is that AVI file contains only video and audio data but lose the GPS coordinates, speed and G-sensor data. so, we would recommend to select .sd format when you back the file.

Step 4. Backup Path: Select your backup destination (e.g.: C:\BlackBox)

C:\BlackBox [Backup Path]

Step 5. Backup: Click 'backup' to start saving the file to your specified destination



[Backup]

■ Configuration 

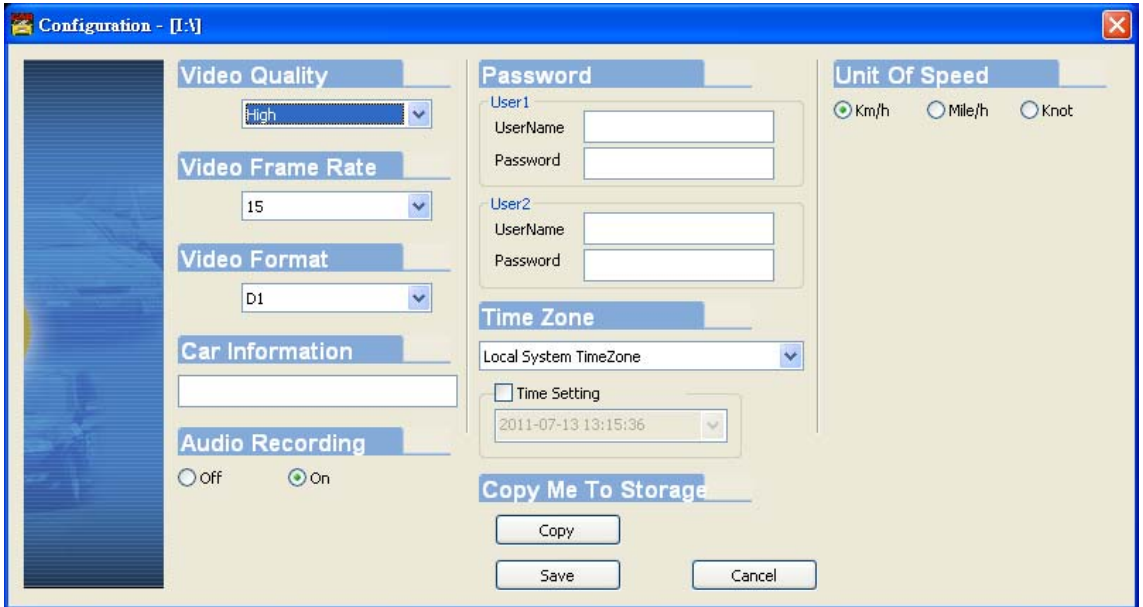
Before using the machine, please insert the SD card to card reader and connect to the PC to start setting. After setting, you can insert the card back to DVR and start recording.

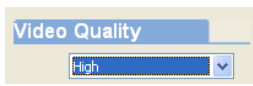
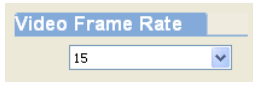
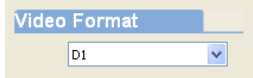
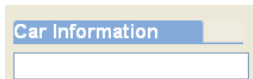
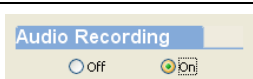

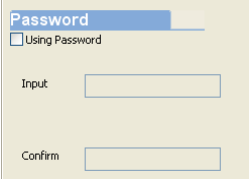
1	Video Quality		Select the video Quality: High/ Normal / Low
2	Video Frame		Set the recording frame rate for the camera (2、4、6、8、10、15、20、25、30)
3	Video Format		video signal format D1/CIF
4	Car Information		You can input the driver's name or license number here to identify people's identity. Suitable for company or group using.
5	Audio Recording		Audio recording on or off.

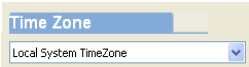
6	password		<p>This function can encrypt the data and prevent others from accessing. Maximum letters:15 letters. Example: 123456789123456</p> <p>After setting the password up, you have to input password every time for playing the files, modify the setting, formatting the memory card etc.</p> <p>★ Note : Please check if you have set capital letters for your password and save your password well in other place to prevent from missing.</p>
7	Speed unit		<p>You can set up the speed unit here.</p> <p>Km/h: kilometer per hour Mile/h: mile per hour Knot : knot per hour</p> <p>★ Note : 1 KM=0.6214 mile, 1 mile=1.6093KM, 1 Knot =1.853KM</p>
8	Time zone		<p>Time Zone: GMT (GPS auto time correction)</p>

■ Snapshot 

While playing the recorded file, you can use this function  to snapshot the picture and save it into your PC.

Default saving path for snapshot picture will be in x:\IBoxPlayer/Snapshot folder. File type: .bmp



b. Latitude & Longitude Coordinates

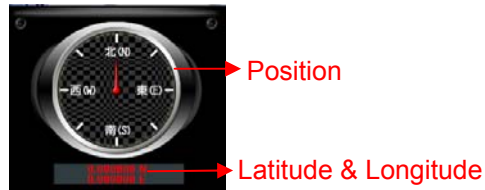

c. G SENSOR

When detecting extraordinary G-force, the machine will record the images and separate the recorded file from normal recording around 1-3 minutes.



- (1) X: The G-force from left & right of the car.
- (2) Y: The G-force from front & back of the car.
- (3) Z: The G-force from upside & downside of the car

d. Speed meter



e. Video Search & Play Speed

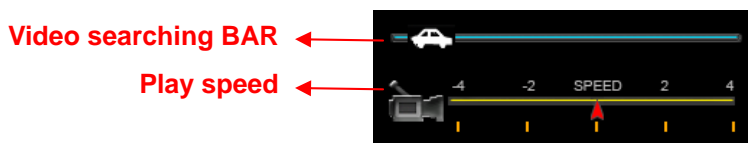



- (1) Video Searching : You can use the mouse to drag the bar to search the video quickly.
- (2) Play Speed : Support 2x, 4x fast forwarding and -2x, -4x slow play mode.

f. Volume control





Volume BAR : Click the left button of mouse control to adjust the volume degree.

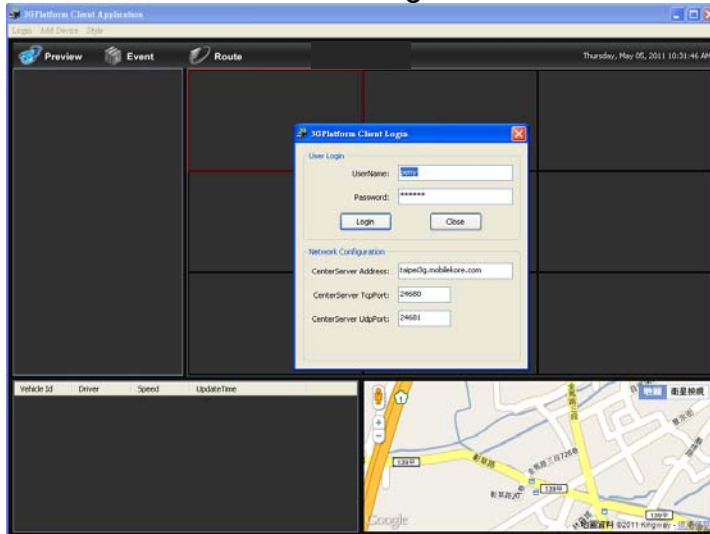

(2) 3G client software for viewing directly(select models with 3G modules)

Executive Playback software “3G ClientApp.exe”  , the playback screen shown as below. Enter the username and password and then press “  ” button to login screen.



★ Note: To perform this software will require DirectX 9.0 or more.

Click  and then select the name of vehicle to view the image(example, the figure of 175) Then click on Channel-01 (or other Channel) and then hold down the left mouse button and drag to the split screen in right side.

The other method to choose split-screen first and then click on Channel-01 with right key of the mouse, click PLAY function to view real-time image.(When the icon becomes  , it means the vehicle that is currently offline. Only the icon return to online status  to see the real-time image.)

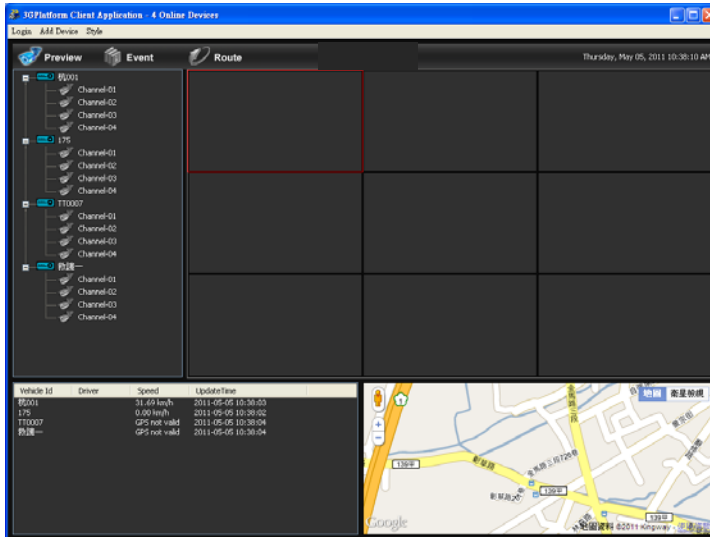

★ Note: When play real-time image, Channel icon will become green .

Click  Event can watch the event log and vehicle driving records...

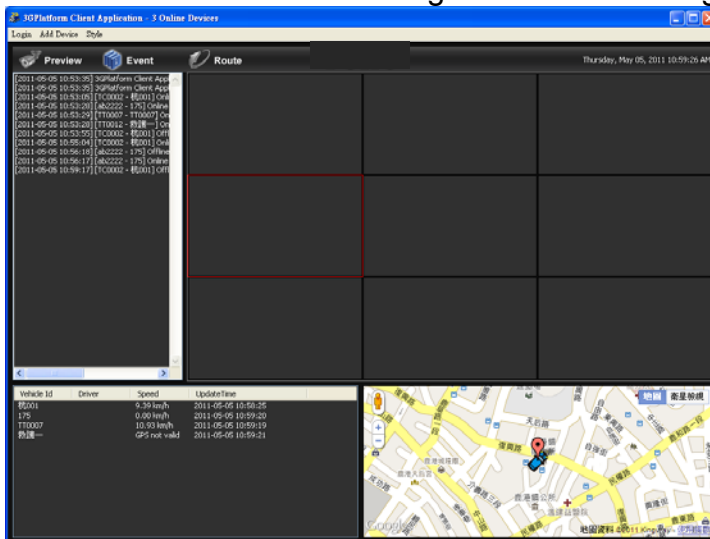

Click  Route can watch the Google Map and inquiry the date and time record of the vehicle.....

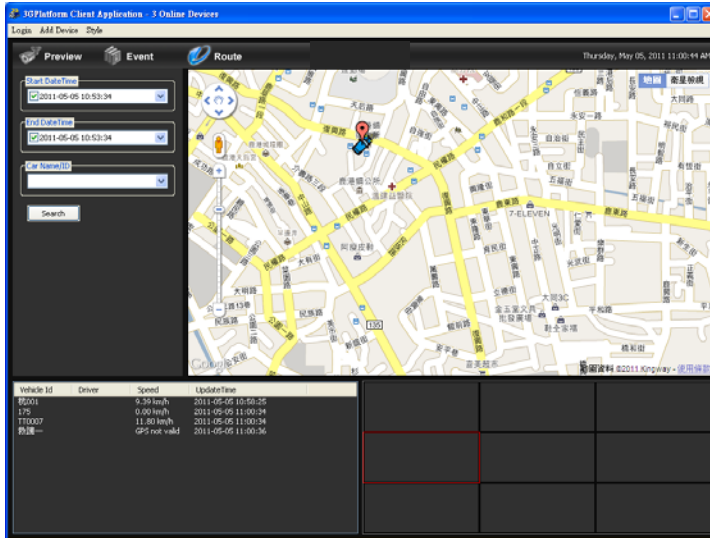

■ 3GClientApp page and other relevant settings

Login Add Device Style

- (1) Login: click Login on the top of the screen to open the login screen information.
- (2) Add Device: In order to identify each device, add the vehicle information here.
- (3) Style: watch different split-screen, just click Style option to set values; Total 1 * 1,2 * 2,3 * 3,4 * 4,4 types of split screen to choose.

2. Playback on DVR site

a. Use remote controller to enter playback menu



b. Use remote controller to select playback file, and enter playback screen





c. Press stop key on remote controller to exit playback screen.

H. Format Memory Card

When should you 「format」 the SD CARD?

When the used SD card or just a new card, you should format SD card first before use. (the SD Card with delivery has been formatted and tested, you can just plug it in DVR).

■ Formatting procedure from PC site:

- (1). Execute the player “CarBox2.exe”  into main page(refer to the charts below)
- (2). Select  format button to start as following steps

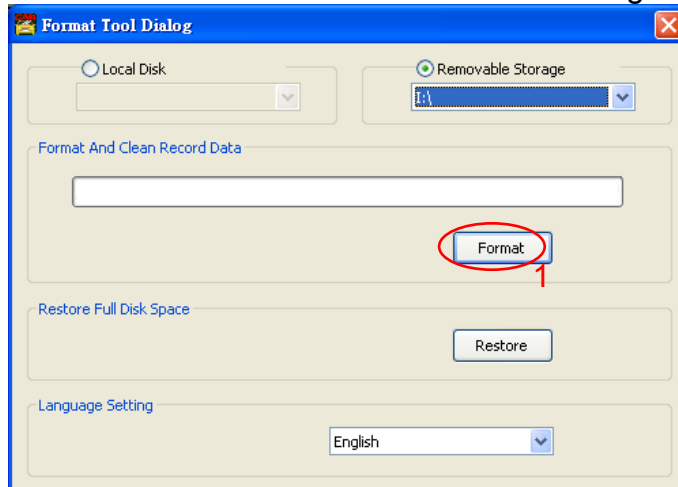

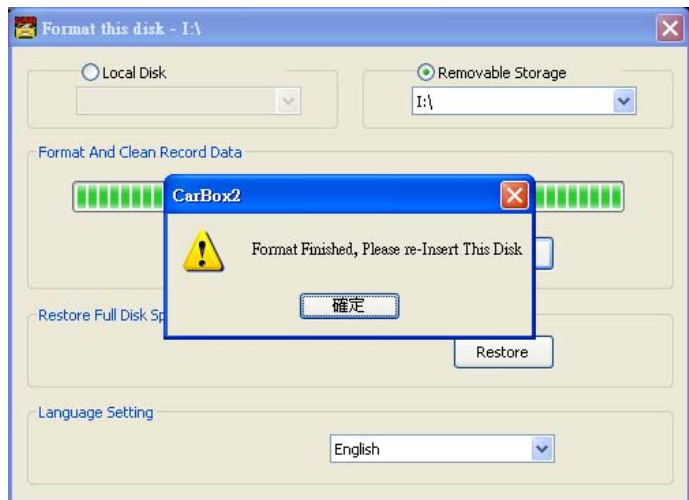
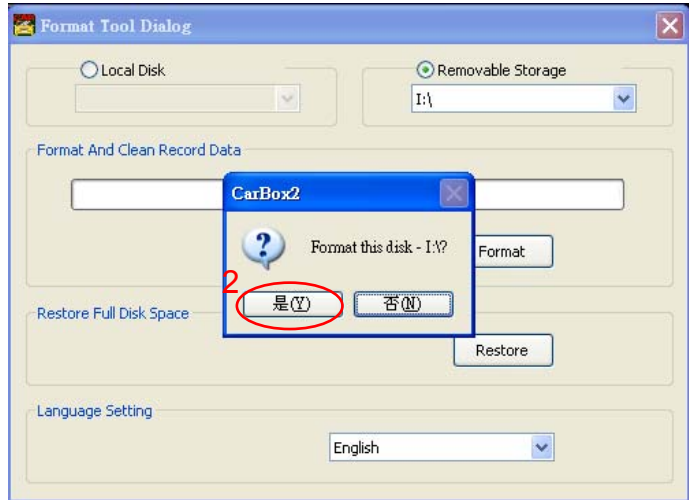

(3). After formatting completed, re-insert the SD card to do relative setting. please insert the card into DVR for recording.

■ Process to Format the SD Card on DVR:

1. Use remote controller to enter DVR menu and choose Delete All the Record Data(format disk).

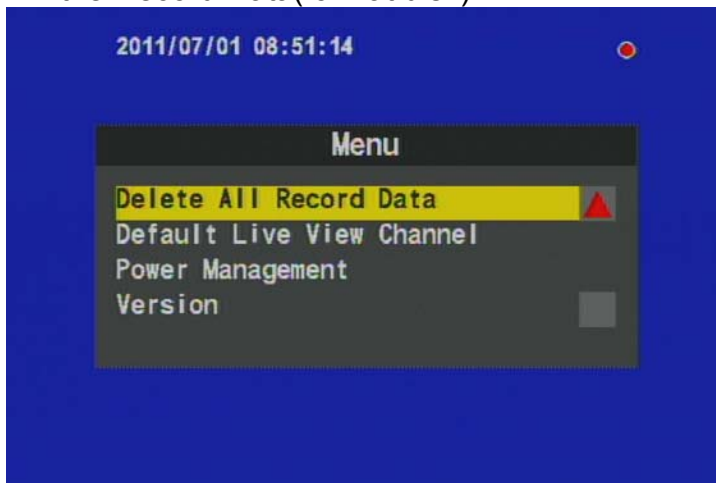

2. Select "Yes" and Click "Enter" to start formatting.



3. When the screen back to LIVE mode ,the formatting is completed.

I. Restoring Memory Card



When should you 「restore」 the SD CARD?

When you have backup the record files into PC and want to use the SD card for other purposes, you can restore the SD Card to normal format, so it can be used correctly.

How to 「restore」 SD card?

Process as following:



1. Put SD card into card reader
2. Put car reader into USB port on PC.
3. Execute the player “CarBox2.exe”  into main page(refer to the charts below )
4. Select restore button to start as following steps
(4.1) click 「restore」 button and it will pop-up the dialog window, click 「yes」 to start restoring.

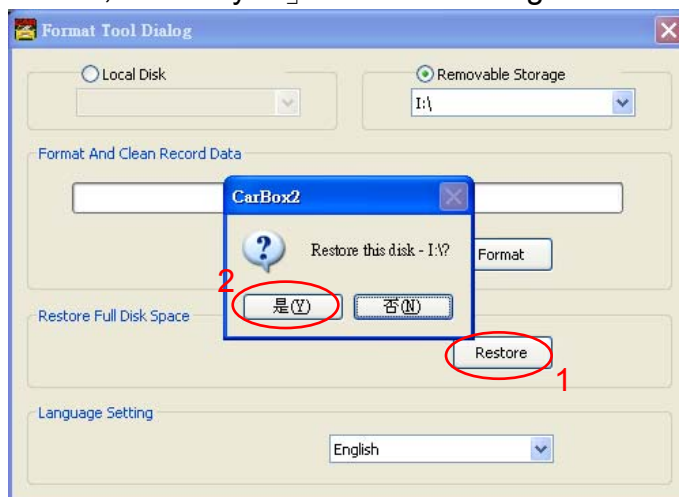

(4.2) System will show up 「Restore this disk」 dialog window



(4.3) Check the quick format and click "Start" to format. After formatting is complete please click "OK", then "Close" dialog window.

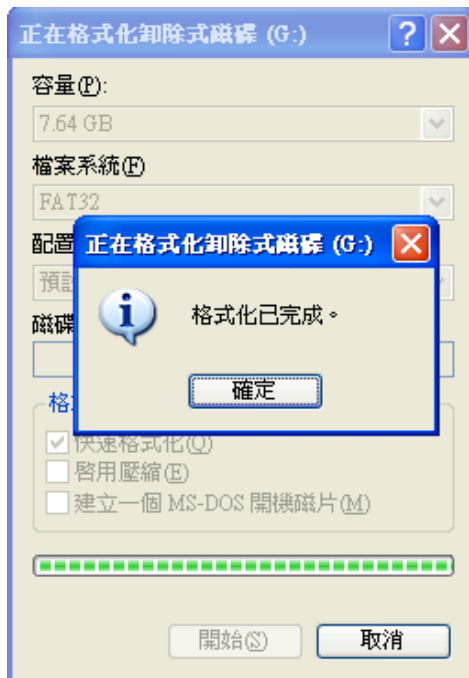

(4.4) Click "OK" to finish restore SD card, After finished, you can use the memory card for other purposes.

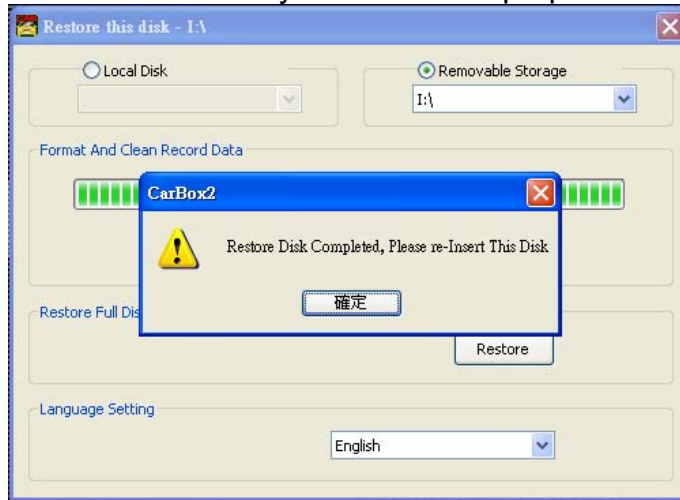

J. 3G-SIM Card Setting (with 3G Module)

When use SIM card in our device, please pay attention to off the PIM code protection feature first.

How to turn off the PIN code protection?

1. Using HUAWEI 3G Module and then plug the SIM card into PCI-E board first. Second, use USB cable to connect PC and PCI-E board and then open the Mobile Partner Program.



2. When open the program, select Tools \ PIN Operations \ Disable PIN Verification ..

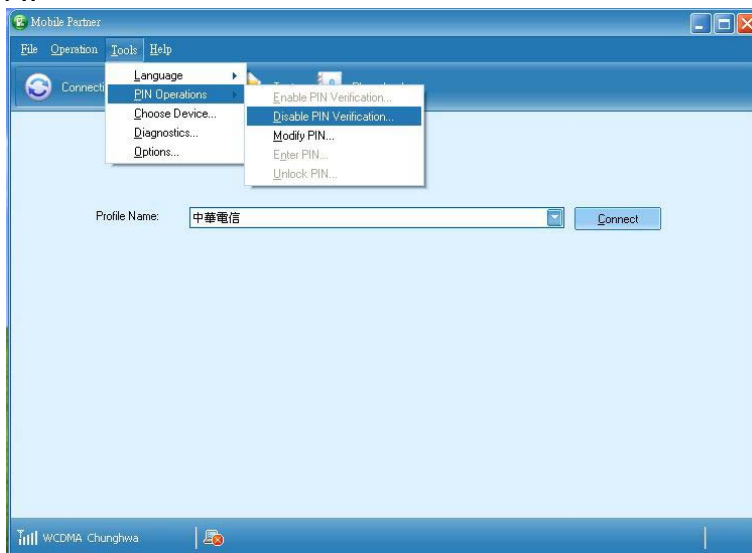

3. Enter correct PIN code (default Chungghwa Telecom: 0000)

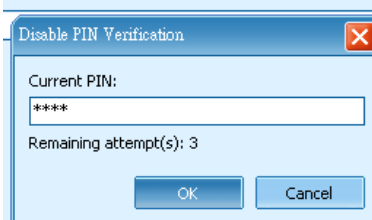

4. Confirm entering correct PIN code and then complete the cancellation PIN code function.



5. After completing above procedure, HUAWEI 3G Module and SIM card on our PCI-E board could connect to 3G system well.

★Unplug the USB cable and replace the original wiring connected to PCI-E board. At this time connect device power and camera well, device will send real-time image to 3G server automatically.